



# KYOCERA DuraForce User Guide

# Table of Contents

---

Get Started .....	1
Your Phone at a Glance.....	1
Set Up Your Phone.....	3
Insert a SIM Card.....	3
Remove a SIM Card .....	4
Charge the Battery.....	5
Charge the Battery Wirelessly .....	5
Turn Your Phone On and Off .....	6
Turn Your Screen On and Off .....	7
Setup Wizard .....	7
Set Up Voicemail .....	7
Phone Basics.....	9
Smart Sonic Capability.....	9
Touchscreen Navigation .....	9
Your Home Screen .....	11
Home Screen Overview .....	11
Extended Home Screens.....	12
Manage the Home Screens .....	12
Clock & Weather.....	15
Dura Grid.....	16
Launcher Screens.....	16
Status Bar.....	17
Notifications Panel.....	18
Quick Settings .....	19
Enter Text.....	20
Google Keyboard.....	20
Google Voice Typing .....	22
Copy and Paste Text.....	23
Phone Calls .....	24
Make Phone Calls.....	24

Call Using the Phone Dialpad .....	24
Call from Recent Calls .....	25
Call from Contacts .....	25
Call Using a Speed Dial Number .....	25
Call Emergency Numbers .....	25
Call Numbers with Pauses .....	26
Call Using the Plus (+) Code.....	26
Call Using Internet Calling .....	27
Receive Phone Calls.....	27
Voicemail .....	28
Set Up Voicemail .....	28
Voicemail Notification .....	28
Retrieve Your Voicemail Messages .....	29
Phone Call Options.....	29
In-call Options.....	29
Caller ID .....	30
Call Waiting .....	31
3-Way Calling .....	31
Call Forwarding .....	32
Set Up Speed Dialing.....	32
Recent Calls .....	33
Call Settings .....	35
Phone Ringtone.....	35
Vibrate When Ringing.....	35
Incoming Call.....	35
Voicemail Settings .....	35
Dial Pad Touch Tones .....	36
Quick Responses.....	36
Fixed Dialing Numbers .....	36
Auto-retry.....	37
TTY Mode.....	37
Voice Privacy.....	38
Call Restrictions.....	38

DTMF Tones.....	38
Auto Answer .....	38
Call Timer .....	38
Contacts.....	40
Contacts List.....	40
Add a Contact.....	41
Save a Phone Number.....	42
Edit a Contact .....	43
Add a Group Contact .....	46
Edit a Group Contact .....	46
ICE (In Case of Emergency) .....	47
Synchronize Contacts .....	48
Share a Contact.....	48
Accounts and Messaging .....	50
Gmail / Google.....	50
Create a Google Account.....	50
Sign In to Your Google Account.....	51
Access Gmail.....	51
Send a Gmail Message .....	52
Read and Reply to Gmail Messages.....	52
Email .....	53
Add an Email Account .....	53
Add a Corporate Account.....	53
Send an Email Message.....	54
View and Reply to Email.....	55
Manage Your Email Inbox.....	56
General Email Settings .....	56
Email Account Settings.....	57
Text and Multimedia Messaging.....	58
Send a Text Message.....	59
Send a Multimedia Message (MMS) .....	59
Save and Resume a Draft Message .....	61
New Messages Notification.....	61

Manage Message Conversations.....	61
Text and MMS Options .....	64
Social Networking Accounts.....	65
Google+.....	65
YouTube.....	65
Apps and Entertainment.....	67
Google Play Store App .....	67
Find and Install an App .....	67
Create a Google Wallet Account.....	68
Google Play Store Options .....	68
Request a Refund for a Paid App .....	69
Open an Installed App .....	69
Uninstall an App .....	69
Navigation.....	70
Google Maps .....	70
Music .....	72
Music Player .....	72
Play Music .....	75
Back Up Your Downloaded Music Files .....	76
Web and Data.....	77
Wi-Fi.....	77
Turn Wi-Fi On and Connect to a Wireless Network.....	77
Check the Wireless Network Status.....	78
Connect to a Different Wi-Fi Network.....	78
The Wi-Fi Settings Menu .....	78
Data Services .....	79
Launch a Web Connection.....	79
Data Connection Status and Indicators.....	80
Virtual Private Networks (VPN) .....	80
Prepare Your Phone for VPN Connection.....	80
Install Security Certificates.....	81
Add a VPN Connection.....	81
Connect to or Disconnect from a VPN .....	81

Browser .....	82
Launch the Web Browser.....	82
Learn to Navigate the Browser .....	82
Browser Menu .....	83
Select Text on a Web Page .....	84
Adjust Browser Settings.....	85
Set the Browser Home Page .....	87
Manage Bookmarks.....	87
Portable Wi-Fi Hotspot.....	88
Tethering .....	89
USB Tethering.....	90
Bluetooth Tethering .....	90
Camera and Camcorder.....	91
Use the Camera App .....	91
Open or Close the Camera App.....	91
Viewfinder Screen.....	91
Take a Picture or Record a Video .....	92
Review Screen .....	92
Camera and Camcorder Settings.....	94
View Pictures and Videos Using Gallery .....	95
Open or Close Gallery .....	96
View Pictures and Videos .....	97
Zoom In or Out on a Picture.....	97
Work with Pictures .....	97
Picture Options Menu .....	97
Edit a Picture .....	98
Share Pictures and Videos.....	99
Send Pictures or Videos by Email/Gmail.....	99
Send Pictures or Videos by Messaging.....	100
Send Pictures or Videos Using Bluetooth .....	100
Share Pictures and Videos on Google+ .....	100
Share Videos on YouTube.....	100
Tools and Calendar.....	102

Calendar .....	102
Add an Event to the Calendar .....	102
Invite Guests to Your Calendar Event .....	103
Calendar Event Alerts .....	104
View Calendar Events .....	105
Edit Calendar Events .....	106
Show or Hide Calendars .....	106
Synchronize Calendars with Your Phone .....	106
Clock .....	107
Desk Clock .....	107
Alarm .....	108
Timer .....	109
Stopwatch .....	110
Calculator .....	110
Sound Recorder .....	110
Voice Services .....	112
Automatic Speech Recognition (ASR) .....	112
Text-to-Speech .....	113
Voice Search .....	113
Eco Mode .....	113
Bluetooth .....	114
Turn Bluetooth On or Off .....	114
The Bluetooth Settings Menu .....	115
Change the Phone Name .....	115
Connect a Bluetooth Headset or Car Kit .....	115
Reconnect a Headset or Car Kit .....	116
Disconnect or Unpair from a Bluetooth Device .....	116
Send and Receive Information Using Bluetooth .....	117
Near Field Communication (NFC) Technology .....	118
Turn NFC On or Off .....	119
Android Beam .....	119
DiXiM Player .....	120
microSD Card .....	121

Insert or Remove a microSD Card .....	121
View the microSD Card Memory .....	123
Format the microSD Card .....	123
Unmount the microSD Card .....	124
Use the Phone's microSD Card as a Media Device .....	124
File Manager .....	124
Update Your Phone .....	125
Settings .....	126
Wi-Fi Settings .....	126
Bluetooth Settings .....	126
Data Usage Settings .....	126
More Settings .....	128
Airplane Mode .....	128
Default SMS App .....	128
NFC Settings .....	129
Android Beam .....	129
Tethering & Portable Hotspot Settings .....	129
VPN Settings .....	129
Mobile Networks Settings .....	129
Emergency Alerts .....	131
Sound Settings .....	132
Volumes .....	132
Vibrate Intensity .....	132
Music Effects .....	132
Phone Ringtone .....	133
Vibrate Pattern .....	133
Vibrate When Ringing .....	133
Persistent Alerts .....	133
Default Notification Sound .....	134
Dial Pad Touch Tones .....	134
Touch Sounds .....	134
Screen Lock Sound .....	134
Vibrate on Touch .....	134



Hearing Aid.....	134
SD Card Notifications .....	135
Display Settings .....	135
Brightness .....	135
Wallpaper .....	135
Auto-Rotate Screen .....	135
Sleep .....	136
Daydream.....	136
Change Text Font.....	136
Font Size .....	136
Key Backlight.....	137
Display Battery Percentage .....	137
Wireless Display .....	137
Programmable Key .....	137
Storage Settings .....	138
Your Phone's Memory .....	138
SD Card.....	138
USB Storage.....	138
Battery Settings .....	139
Connectivity Settings .....	139
Apps Settings.....	140
Tap & Pay.....	140
Location Settings .....	140
Lock Screen Settings .....	141
Screen Lock.....	141
Improve Face Matching .....	143
Liveness Check .....	143
Make Pattern Visible.....	143
Screen Lock Time.....	143
Power Key Instantly Locks.....	144
Show Instructions .....	144
Enable Widgets .....	144
Owner Information .....	144

Security Settings.....	144
Encrypt & Decrypt Data .....	144
Make Passwords Visible .....	145
Reset Password .....	145
Device Administrators.....	146
Unknown Sources.....	146
Verify Apps .....	146
Credential Storage.....	146
Language & Input Settings.....	147
Language Settings.....	147
Spell Checker .....	147
Personal Dictionary.....	147
Default Text Input .....	148
Google Keyboard Settings.....	148
Google Voice Typing Settings.....	149
Voice Search Settings .....	149
Text-to-Speech Settings .....	150
Pointer Speed.....	150
Backup & Reset Settings .....	150
Backup & Restore.....	150
Factory Data Reset.....	151
Accounts Settings .....	151
Date & Time Settings .....	152
Accessibility Settings .....	152
Services.....	152
Vision.....	153
Hearing.....	154
Mobility .....	154
Others.....	155
Printing .....	155
About Phone.....	156
Notes .....	157
Copyright & Trademarks .....	158

# Get Started



The following topics give you all the information you need to set up your phone and U.S. Cellular<sup>®</sup> service the first time.

## Your Phone at a Glance

The following illustration outlines your phone's primary external features and keys.



## Key Functions

- **LED Indicator** displays a phone notification, charging status, or alert.
- **Front Camera** takes pictures and records videos while facing the screen, and allows you to video conference.
- **Proximity/Light Sensor** detects how close an object is to the surface of the screen. This is typically used to detect when your face is pressed up against the screen, such as during a phone call.
- **Touchscreen** displays all the information needed to operate your phone. Use finger gestures to navigate and interact with items on the screen.
- **Home Key**  returns you to the Home screen. Press and hold to open the Google search app.
- **Back Key**  lets you return to the previous screen, or close a dialog box, options menu, the Notifications panel, or onscreen keyboard.
- **Recent Apps Key**  displays the list of apps you have recently accessed.
- **Speakers** let you hear different ringtones and sounds. The speakers also let you hear the caller's voice in speakerphone mode.
- **Secondary Microphone** suppresses background noise improving audio quality for the other party during voice calls. In speakerphone mode, it is used as the main microphone.
- **Power/Lock Key** lets you turn the phone on or off or turn the screen on or off, restart the phone, or switch your phone to silent mode, vibration mode, or Airplane Mode.
- **Speaker Key** lets you place or receive calls in speakerphone mode or turn the speakerphone on and off during a call.
- **Audio Jack** allows you to plug in an optional headset for convenient, hands-free conversations or for listening to music.
- **Primary Microphone** transmits your voice for phone calls and is used for voice-activated functions. It is disabled in speakerphone mode.
- **USB/Charging Port** allows you to connect the phone and the USB cable for use with the charger adapter or other compatible accessories.
- **Volume Key** allows you to adjust the ringtone or media volume when you are not on a call or adjust the voice volume during a call.
- **Programmable Key** allows you to assign your favorite behavior to it.
- **microSD Card/SIM Card Slots** allows you to insert a SIM card and a microSD card.

**Note:** microSD card is sold separately.

- **Back Camera** lets you take pictures and videos.
- **Camera Flash** helps illuminate subjects in low-light environments when taking a picture or recording a video.

**CAUTION!** Inserting an accessory into the incorrect jack or port may damage the phone.

## Set Up Your Phone

You need to insert a SIM card to your phone and charge the battery to begin setting up your phone.

**Note:** A SIM card is inserted into your phone by default.

### Insert a SIM Card

If not already inserted, follow the instructions below to insert your SIM card.

**Warning:** Use only a Nano SIM card for this phone.

1. Locate and open the cover to the microSD card/SIM card slots on the side of the phone.

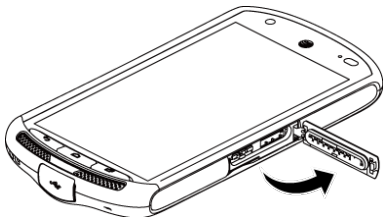

2. Place the SIM card on the SIM card tray so that the cut corner of the card follows the shape of the tray. Holding the card and the tray with your fingers, insert them into the SIM card slot on the left and close the cover.

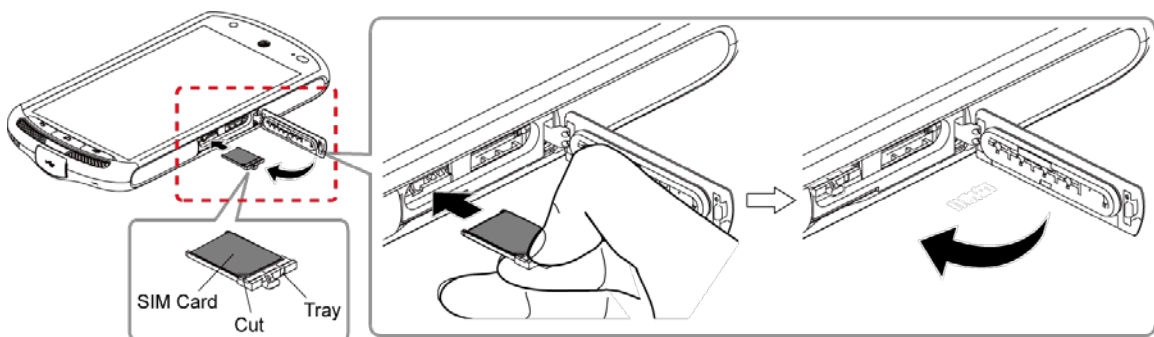

3. Press around the edges of the cover to the microSD card/SIM card slots to ensure that it is securely closed.

**Warning:** Be sure all ports and covers are properly sealed to maintain the phone's waterproof capability.

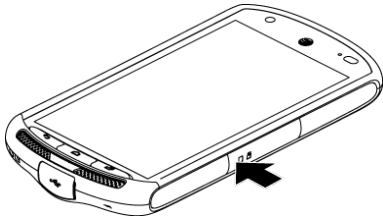

## Remove a SIM Card

You can remove the SIM card to use it with other compatible phones.

1. Turn off your phone.
2. Locate and open the cover to the microSD card/SIM card slots on the side of the phone.



3. Holding the tab on the SIM card tray with your fingers, gently pull the tray and the SIM card out of the slot and close the cover.

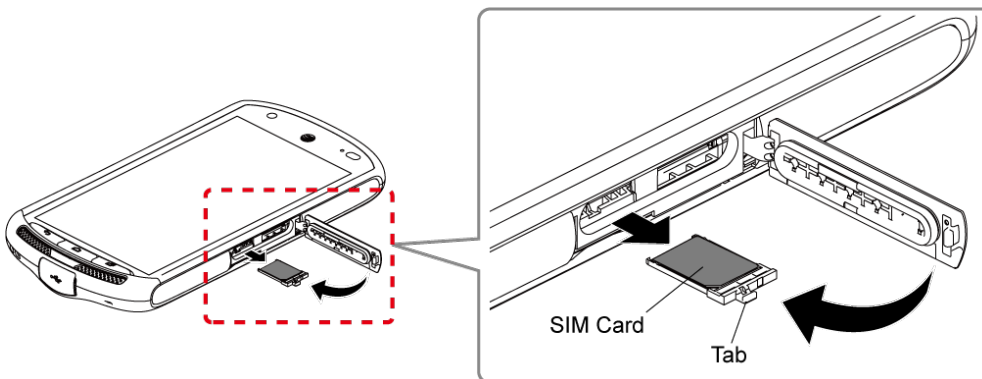

4. Press around the edges of the cover to the microSD card/SIM card slots to ensure that it is securely closed.

**Warning:** Be sure all ports and covers are properly sealed to maintain the phone's waterproof capability.

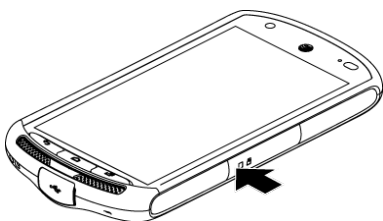

## Charge the Battery

Fully charge the battery before powering the phone on.

**Important:** Before turning on your phone, charge the battery fully with the charger that came with your phone.

1. Open the cover to the USB/charging port on the bottom of the phone.
2. Plug the smaller end of the USB cable into the phone's USB/charging port.
3. Plug the other end of the USB cable into the charger, and then plug the charger into an electrical outlet.

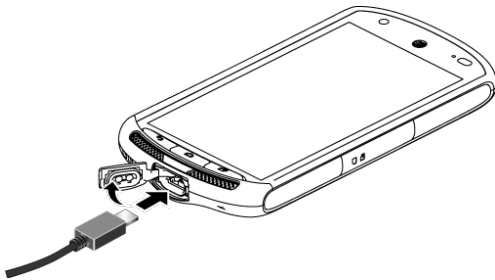

4. When charging is complete, remove the cable from the port and close the cover. Press around the edges of the cover to ensure that it is securely closed.

**Warning:** Be sure all ports and covers are properly sealed to maintain the phone's waterproof capability.

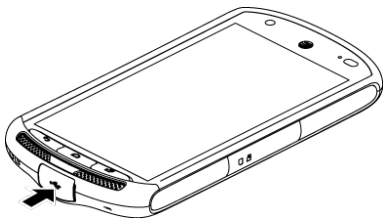

## Charge the Battery Wirelessly

Your phone supports Qi and works with Qi-enabled chargers. Follow the steps below to charge the battery wirelessly.

1. Locate the charging area on your wireless charger by referring to the charger documentation.
2. Place your phone in contact with the charger, ensuring that the charging area of your phone touches the charging area of your wireless charger.



Before starting wireless charging, please note the following:

- If the charging areas are not touching, the charging results will be poor.
- Make sure there is nothing between your phone and wireless charger.
- Your phone may become hot while charging the battery.
- If charging doesn't start after positioning your phone correctly, please use the charger that came with your phone.

For more information on wireless charging, see your wireless charger documentation.

## *Turn Your Phone On and Off*

The instructions below explain how to turn your phone on and off.

### Turn Your Phone On

- ▶ Press and hold the **Power/Lock** key until the screen lights up.

### Turn Your Phone Off

1. Press and hold the **Power/Lock** key until the phone options are displayed.
2. Tap **Power off** > **OK** to turn the phone off.

### Restart Your Phone

1. Press and hold the **Power/Lock** key until the phone options are displayed.
2. Tap **Restart** > **OK** to restart the phone.



## Hard Reset

- ▶ Press and hold the **Power/Lock** key and the volume up key together for more than ten seconds. The phone will shut down and automatically start up.

## Turn Your Screen On and Off

Your phone allows you to quickly turn the screen off when not in use and to turn it back on when you need it.

### Turn the Screen Off When Not in Use

- ▶ To quickly turn the screen off, press the **Power/Lock** key. Pressing the **Power/Lock** key again or receiving an incoming call will turn on your phone screen.

To save battery power, the phone screen automatically turns off after a certain period of time when left idle. You will still be able to receive messages and calls while the phone screen is off.

**Note:** For information on how to adjust the time before the screen turns off, see [Sleep](#).

### Turn the Screen On and Start with Swipe

1. To turn the screen on, press the **Power/Lock** key.

**Note:** To set up a screen lock for security, see [Lock Screen Settings](#).

2. On the default screen, swipe  toward:
  - **Start** to access the Home screen or the screen displayed before it was turned off.
  - **Camera** to launch the Camera app.
  - **Phone** to launch the Phone app.

## Setup Wizard

Setup Wizard helps you configure certain features and preferences such as language, Wi-Fi network, email, and more.



- ▶ When you turn on your phone for the first time, the Setup Wizard screen will appear. Follow the onscreen instructions.

**Note:** You can access the Setup Wizard screen by pressing  >  > **Setup** if you decide to set it up later.

## Set Up Voicemail

You should set up your voicemail and personal greeting as soon as your phone is activated. Always use a password to protect against unauthorized access. Your phone automatically

transfers all unanswered calls to your voicemail, even if your phone is in use or turned off. See [Voicemail](#) for details.

1. Press  > **Phone** > **Dialpad**.
2. Touch and hold  to dial your voicemail number.
3. Follow the system prompts to:
  - Create your password.
  - Record your name announcement.
  - Record your greeting.

**Important:** **Voicemail Password** – It is strongly recommended that you create a password when setting up your voicemail to protect against unauthorized access. Without a password, anyone who has access to your phone is able to access your voicemail messages.

# Phone Basics

---

Your phone is packed with features that simplify your life and expand your ability to stay connected to the people and information that are important to you. The following topics will introduce the basic functions and features of your phone.

## Smart Sonic Capability

The Smart Sonic receiver inside your phone transmits sound by way of vibrations throughout the entire area of the display screen. Adjust the position of the phone screen to your ear to find the best hearing point in the surrounding environment.

**Note:** Do not cover the microphones during a call as it may compromise the hearing quality.

## Touchscreen Navigation

Your phone's touchscreen lets you control actions through a variety of tap gestures.

### Tap



Tap the screen with your finger to select or launch a menu, option, or application. A light tap works best.

### Touch and Hold

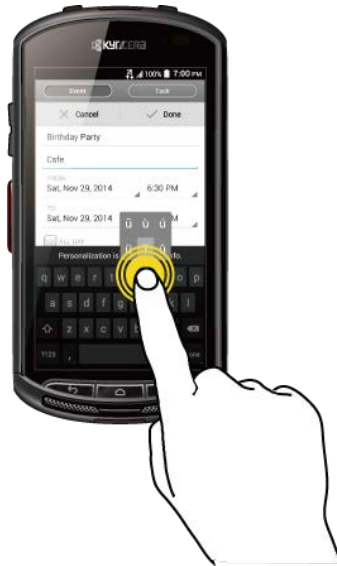

To open the available options for an item (for example, a keyboard), touch and hold the item.

### Drag



Touch and hold your finger before you start to move it. Do not release your finger until you have reached the target position.

## Swipe or Slide



To swipe or slide means to quickly drag your finger vertically or horizontally across the screen.

## Flick



Flicking the screen is similar to swiping, except that you need to swipe your finger in light, quick strokes.

## Pinch and Spread



Pinch the screen using your thumb and forefinger to zoom out or spread the screen to zoom in when viewing a picture or a Web page. (Move fingers inward to zoom out and outward to zoom in.)

## Rotate



For most screens, you can automatically change the screen orientation from portrait to landscape by turning the phone sideways. When entering text, you can turn the phone sideways to bring up a bigger keyboard. See [Touchscreen Keyboards](#).

**Note:** The **Auto-rotate screen** check box needs to be selected for the screen orientation to automatically change. Press  >  > **Settings** > **Display** > **Auto-rotate screen**.

## Your Home Screen

The Home screen is the starting point for your phone's applications, functions, and menus. You can customize your Home screen by adding application icons, shortcuts, folders, widgets, and more. Press  to return to the Home screen from any other screen.

### Home Screen Overview

The following illustration displays the basics of the Home screen.



- **Status Bar:** Displays the time, notification icons, and phone status icons. Slide down to display the Notifications panel. See [Status Bar](#).
- **Google Search Bar:** Allows you to enter text or spoken keywords for a quick search on the phone or on the Internet. Tap to enter text or tap  to speak your keyword.
- **Widget:** Allows users to access various useful programs.
- **Shortcut:** Allows you to quickly launch applications.
- **Folder:** Allows you to organize screen items. You can store multiple application icons together in a folder. See [Use Folders](#).
- **Screen Position Indicator:** Indicates where you are among the maximum of nine Home screens. Tap an indicator icon to access the corresponding Home screen.
- **Application Launcher:** Displays available applications and widgets on the phone.

- **Favorites Tray:** Contains up to five icons and appears on every Home screen. You can customize these icons except the application launcher icon in the center of the tray.



## Extended Home Screens

The Home screen extends beyond the initial screen. In addition to the main Home screen, your phone can have up to eight extended Home screens to provide more space for adding icons and widgets.



- ▶ On the Home screen, swipe across the screen to move from the main Home screen to an extended Home screen.

– or –

On the screen position indicator, tap  to access the main Home screen, or tap  to access each extended Home screen.

## Manage the Home Screens

Learn how to customize the Home screens.

### Add or Reduce the Home Screens

You can have between one to nine Home screens.



1. Lightly pinch any Home screen with your thumb and index finger to display the Home screen thumbnails.
2. The following options are available:
  - Tap a thumbnail to access the Home screen.
  - Tap  to add a new Home screen.



- Touch and hold a thumbnail and drag it to rearrange the positions of the Home screens. Release the thumbnail where you want to place it.
- Touch and hold a thumbnail, drag it to **“Remove”** and release it when it turns red to remove the Home screen. The main Home screen cannot be removed.
- Tap the Home icon at the top of each screen thumbnail to set the screen as the main Home screen.

3. Tap **Done**.

### Add App Shortcuts or Widgets to the Home Screen

1. Press  > .
2. Tap **Apps** or **Widgets**.
3. Slide the screen to find the item you want to add to the Home screen.
4. Touch and hold the item and drag it to **“Add to Home screen”** at the top of the screen.
5. Still holding the item, move your finger to find a place to add it to. As you move your finger, pale frames appear on the screen to indicate where you might place the item.
6. When you find the position to place the item, release your finger.

– or –

1. Touch and hold the empty area on the Home screen.
2. Tap **Apps** or **Widgets**.
3. Slide the screen to find the item you want to add to the Home screen.
4. Touch and hold the item and move your finger to one of the Home screens.
5. When you find the position to place the item, release your finger.

**Tip:** You can also select a Home screen thumbnail where you want to place the item and then simply tap the item.

### Move or Remove Items on the Home Screen

- ▶ Touch and hold the item you want to move or remove from the Home screen.
  - To move the item, drag it to a new area and release it.
  - To remove the item, drag it to **“Remove”** at the top of the screen and release it when it turns red.

## Favorites Tray

The favorites tray takes up to five icons and appears on every Home screen. You can replace those icons except the application launcher icon in the center of the tray.

To add a new icon to the favorites tray:

1. Remove the current icon on the tray. See [Move or Remove Items on the Home Screen](#).
2. Touch and hold an app icon and drag it to the favorites tray.
3. Release your finger.

## Use Folders

You can place up to 16 app icons in a folder. Drop an app icon over another on the Home screen, and the two icons will be in the same folder.

To create a folder:

1. Touch and hold an app icon and drag it over another on the Home screen.
2. Release your finger. Both icons are in a created folder.
3. Tap the folder > **Unnamed Folder**. The keyboard opens and you can name the folder. To rename it, tap the name.

To add app icons to a folder:

- ▶ Touch and hold an app icon, drag it over a folder and release your finger.

– or –

1. Tap a folder on the Home screen.
2. Tap  and select the icons you want to add to the folder.
3. Tap **Done**.

To remove app icons from a folder:

1. Tap a folder on the Home screen.
2. Touch and hold an app icon, drag it to “**Remove**” at the top of the screen and release it when it turns red.

## Change the Wallpaper

1. Touch and hold the empty area on the Home screen and then tap **Wallpapers**.

– or –





Press  >  > **Settings** > **Display** > **Wallpaper**.

2. Tap an option:
  - **Gallery** to set a saved picture in **Gallery**. Select an album, select an image and zoom in and out on the image to resize it.
  - **Live wallpapers** to set a live wallpaper. Select an image. You may tap **Settings...** to select custom settings for the live wallpaper.
  - **Photos** to set a saved picture in **Photos**. Select an image and zoom in and out on the image to resize it.
  - **Wallpapers** to set a preset wallpaper. Slide the thumbnails on the screen sideways to see available options and select an image.
3. Tap **Set wallpaper** or **SET WALLPAPER**.



## Clock & Weather

Your Clock & Weather widget can display multiple time and weather information. To use the clock feature, tap the time display on the widget to access the Clock app. See [Clock](#) for details.



### Retrieve the Current Location Information

1. Tap **Tap to start** on the widget.
2. Read the message and tap **OK** to enable data connection.
3. Tap **Enable location** on the widget and enable the location settings if it is not enabled. See [Location Settings](#).
4. Press  to return to the Home screen and tap  on the bottom right of the widget.

### Add a Location

1. Tap the weather image on the widget and then tap  > .
2. Enter a location in the **Search location** field and tap . The matching location(s) will be listed.
3. Tap the location you want to add to the location list.
4. Tap the added location to access the details screen. You can also access the details screen of the added location by tapping the weather image on the widget and then sliding the screen to the left.

## Delete a Location

1. Tap the weather image on the widget and then tap  > .
2. Select the check box next to the location you want to delete.
  - Tap **Select all** to select all the locations.
3. Tap **Done**.

## Configure the Settings

1. Tap the weather image on the widget and then tap .
2. The following options are available:
  - **Temperature scale:** Select **Fahrenheit** or **Celsius**.
  - **Auto update:** Select the frequency of auto update.

## Dura Grid

The Dura Grid widget offers popular settings and apps and is uniquely designed with high contrast, large icons for easy access with gloved hands or while on the move. The Dura Grid widget can also be customized with most frequently used apps and settings and is available in a six or nine-position layout.

### Add a Dura Grid Widget to the Home Screen

- ▶ See [Add App Shortcuts or Widgets to the Home Screen](#).

### Change an Icon on the Dura Grid Widget





1. Tap **Edit** on Dura Grid. A red “X” appears in the right hand corner of each of the icons.
2. Tap the setting or feature to be changed. The icon disappears.
3. Tap **Add** and tap on an icon from the **Controller** or **Apps** tabs.
4. Tap **Done**.

## Launcher Screens



You can access all your apps and widgets on your phone from the launcher screens. You can also customize the view of your launcher screens.

### Access the Launcher Screens

1. Press  > 

2. The following options are available:
  - Tap **Apps** to display the apps on your phone.
  - Tap **Widgets** to display the widgets on your phone.
  - Tap  to display the apps downloaded on your phone.
  - Tap  to search apps on your phone.
  - Tap  > **Reset app order** to reset the order of apps to default.
  - Tap  > **Sort apps by** to customize the order of apps. See [Rearrange Your Apps on the Launcher Screens](#).
  - Tap  > **Manage apps** to access the apps settings screen. See [Apps Settings](#).







### Rearrange Your Apps on the Launcher Screens









1. Press  >  >  > **Sort apps by**.
2. Touch and hold an app, drag it to a new position and release it. To move it to another screen, drag the app to "**Jump to another screen**" and release it on the screen you want to place it.
3. Tap **Done**.

## Status Bar











The status bar at the top of the screen provides phone and service status information on the right side and notification alerts on the left.

### Status Icons

Icon	Status
	Bluetooth® active
	Wi-Fi® active
	Vibrate
	Silent
	Network (full signal)
	Network (no signal)
	4G LTE (data service)

Icon	Status
	3G (data service)
	Airplane mode
	GPS active
	Alarm set
	Battery (charging)
	Battery (full charge)
	Battery (discharged)
	Battery (needs to be replaced)

## Notification Icons

Icon	Notification
	Missed call
	Battery (full charge)
	New email
	New Gmail
	New message
	Event
	Play Music active
	USB connection
	Alarm
	Downloading

## Notifications Panel

You can open the Notifications panel to view the list of notifications you received, Wi-Fi connection status, and more.

To open the Notifications panel:

- ▶ Slide the status bar down to the bottom of the touchscreen.

– or –

Press  > **Notifications**.

## Quick Settings

The quick settings screen enables you to quickly access useful menu items. For more information on the settings menus, see [Settings](#).

1. Slide the status bar down to the bottom of the touchscreen.
2. Tap  at the top right of the screen.

**Tip:** Tap  to go back to the Notifications panel.

3. Tap the following options:
  - **MY INFO** to display your information.
  - **BRIGHTNESS** to access the brightness settings screen.
  - **SETTINGS** to access the phone's settings menus.
  - **WI-FI** to enable or disable the Wi-Fi function. Touch and hold to access the Wi-Fi settings menus.
  - **SIGNAL** to access the data usage settings menu.
  - **BATTERY** to access the battery settings menus.
  - **AIRPLANE MODE** to enable or disable the Airplane Mode.
  - **BLUETOOTH** to enable or disable the Bluetooth function. Touch and hold to access the Bluetooth settings menus.
  - **LOCATION** to enable or disable the location feature. Touch and hold to access the location settings menus.
  - **RINGTONE & NOTIFICATIONS** to switch between **SOUND ON**, **VIBRATE**, and **SILENT**.
  - **NFC** to enable or disable the NFC feature. Touch and hold to access the NFC settings menus.
  - **ECO MODE** to enable or disable the Eco Mode feature. Touch and hold to launch the Eco Mode app.
  - **ROTATE** to enable or disable the auto-rotate screen feature.

## Enter Text

You can type on your phone using a touchscreen keyboard or using your voice. The keyboard appears automatically onscreen when you tap a text entry field and it can be used in either portrait or landscape mode.

## Google Keyboard



Google Keyboard offers a traditional QWERTY keyboard setup for entering text by tapping keys (like on a computer), along with enhancements and options that allow you to enter text faster and more accurately, such as continuous key input, personalized usage dictionaries, and more.

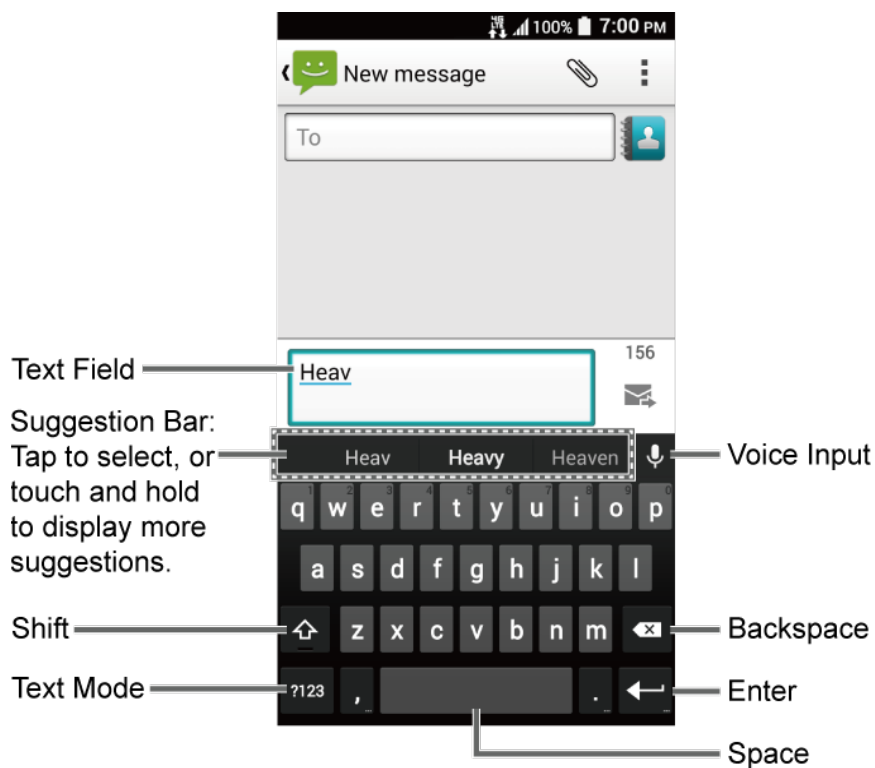







### Google Keyboard Overview



**Note:** Key appearance may vary depending on the selected application or text field.









Some of the keys on the Google Keyboard are given below:

Key	Description
	<b>Shift:</b> Tap to toggle between lower case and upper case.
	<b>Caps lock:</b> Double-tap the lower case or upper case shift key.

Key	Description
 	<b>Text mode:</b> Tap to toggle between the Alphabet keyboard and Number & Symbol keyboard.
	<b>Voice input mode:</b> Tap to enter text using your voice.
	<b>Backspace:</b> Tap to delete a character. Touch and hold to delete multiple characters.
	<b>Smiley:</b> Tap to display the emoji keyboard.
	<b>Enter:</b> Tap to confirm your entry or move to a new line. Smiley will be displayed by touching and holding.
 	<b>Alternate:</b> Tap to toggle between the default Number & Symbol keyboard and additional Number & Symbol keyboard.
	<b>Space:</b> Tap to insert a space. Touch and hold to select the input method.

## Text Mode





ABC mode is primarily used for entering letters while Number & Symbol mode for numbers and symbols.

- ▶ Tap  to select ABC mode. Tap  to select Number & Symbol mode.
  - In ABC mode, tap  to alter the capitalization:
    -  (Unshifted) to enter all letters in lowercase.
    -  (One-character-shifted) to capitalize only the first letter of a word.
  - You can select the caps lock by double-tapping or touching and holding  or  to make all letters in uppercase.
    -  (Caps lock) to enter all letters in uppercase.
  - In Number & Symbol mode, tap  to display more symbols.

- Some keys have alternate characters. If a key displays an extra character at the upper right corner, touch and hold the key to enter the character. Or, touch and long hold a key to call up a list of all the characters available on that key, and slide your finger to the character you want to enter on the list.

## Add a Word to the User Dictionary

You can use the user dictionary option to add new words to the dictionary.

1. Press  >  > **Settings** > **Language & input** > **Personal dictionary**.
2. Select a language.
3. Tap .
4. Type the word you want to add.
5. Type the shortcut to bring up the typed word, if you want.
6. Press . A list of words you have added to the dictionary is displayed.
  - Tap a word to edit it.
  - Tap a word >  to delete it.



For more information about the Google Keyboard settings, see [Google Keyboard Settings](#).

## Google Voice Typing

Google voice typing uses Google voice recognition to convert speech to text.

If the Google Keyboard does not display the microphone icon , the voice input feature is not enabled.

To enable the voice input feature:

1. Press  >  > **Settings** > **Language & input**.
2. Select the **Google voice typing** check box if it is not selected.
3. Tap  next to **Google Keyboard** > **Voice input key**.

To enter text by speaking:

1. Tap the microphone icon  on the keyboard.
2. If you see **Speak now**, say the text you wish to enter into the microphone. If you see **Tap to pause**, Google Voice Typing recognizes your voice.



3. Confirm the text you wish to enter is displayed. Tap the microphone icon again to continue entering.

For more information about the settings of Google voice typing, see [Google Voice Typing Settings](#).

## Copy and Paste Text

In applications that require text entry, such as Messaging, use the copy and paste functions to copy and paste text from one application to another.

To copy and paste the text:

1. Open the application or received message that you want to copy text from.
2. Touch and hold the text body. Selection tabs appear and the currently selected words or characters are highlighted. Drag the tabs to expand or reduce the range of the selected text.

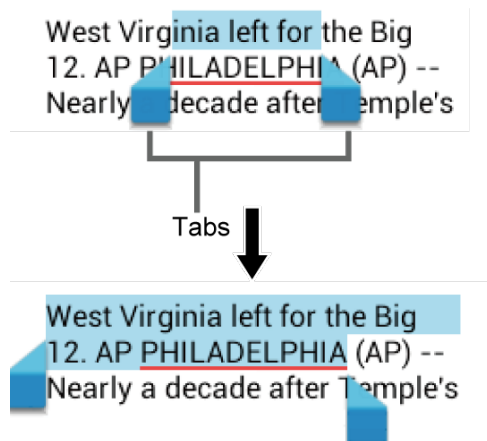

**Tip:** Tap  to select all the text.

3. Tap .
4. Open the application into which you want to paste the text.
5. Touch and hold the text box where you want to paste the text to, and tap **PASTE**.
  - If you want to add the selected text to the current text, place a cursor to the position where you want to insert the selected words or characters. Touch and hold the text box, and tap **PASTE**.

# Phone Calls

With the U.S. Cellular network and your phone's calling features, you can enjoy clear phone calls across the country.

## Make Phone Calls

There are several convenient ways to place calls from your phone.

### Recent Calls

Tap to open the Recent calls list.  
Tap an entry to call.

### Matching Contacts

As you type the number, matching contacts in your Phone book appears. A number appears on the right when multiple numbers match. Tap the number to display all the matches. Tap the contact to call.

### Search

Tap to search your contacts.



### Menu

Tap to open the call options menu.

### Phone Book

Tap to open the Phone book.  
Tap an entry to call.

### Delete

Tap to delete the digit entered.

### Call

Tap to call the phone number entered.



## Call Using the Phone Dialpad

The most "traditional" way to place a call is by using the phone dialpad.

1. Press  > **Phone** > **Dialpad** to display the dialpad.
2. Tap the number keys on the dialpad to enter the phone number.
3. Tap **Call** to call the number.
4. To end the call, tap **End call**.



## Call from Recent Calls

The Recent calls list lets you quickly place calls to recent incoming, outgoing, or missed numbers.

1. Press  > **Phone** > **Recent calls** to display the recent calls list.
2. Tap the name or number to place a call.
  - For additional options, tap  next to the name or number.

## Call from Contacts

You can place phone calls directly from entries in your contacts list.

1. Press  > **Phone**.
2. Your favorites and frequent contacts are displayed.
  - or –
  - Tap **Phone book** to display the phonebook.
    - Tap  to search your contacts.
3. Tap the contact you want to call.

For additional information on Contacts, see [Contacts](#).

## Call Using a Speed Dial Number

Speed dialing lets you contact friends and family easier. See [Set Up Speed Dialing](#) for information on assigning speed dial numbers.

1. Press  > **Phone** > **Dialpad**.
2. For speed dial numbers 2-9, touch and hold the number on the dialpad.

– or –

For speed dial numbers 10-99, tap the first digit and then touch and hold the second digit on the dialpad.

## Call Emergency Numbers

You can place calls to 911 even if the phone screen is locked or your account is restricted.

To call the 911 emergency number:

1. Press  > **Phone** > **Dialpad**.
2. Tap **911** > **Call**.

To call the 911 emergency number when the screen is locked:

1. Tap **Emergency Call** on the screen.
2. Tap  next to **911**.

## Enhanced 911 (E911) Information

This phone features an embedded Global Positioning System (GPS) chip necessary for utilizing E911 emergency location services where available.



When you place an emergency 911 call, the GPS feature of your phone seeks information to calculate your approximate location. Depending on several variables, including availability and access to satellite signals, it may take up to 30 seconds or more to determine and report your approximate location.

**Important:** Always report your location to the 911 operator when placing an emergency call. Some designated emergency call takers, known as Public Safety Answering Points (PSAPs), may not be equipped to receive GPS location information from your phone.

## Call Numbers with Pauses

You can dial phone numbers with pauses for use with automated systems, such as Voicemail or credit card billing numbers.

There are two types of pauses available on your phone:

- **Add 2-sec pause:** Automatically sends the next set of numbers after two seconds.
  - **Add wait:** Sends the next set of numbers when you tap **Yes** in the pop-up window.
1. Press  > **Phone** > **Dialpad**.
  2. Enter all or part of a number.
  3. Tap  > **Add 2-sec pause** or **Add wait**.
  4. Enter additional numbers.
  5. Tap **Call** to dial the number.

## Call Using the Plus (+) Code

When placing international calls, Plus Code Dialing automatically enters the international access code for your location (for example, 011 for international calls made from the U.S.).

1. Press  > **Phone** > **Dialpad**.
2. Touch and hold **0** until you see a “+” on the display screen.

3. Enter the country code and phone number, and then tap **Call**. The phone automatically prepends the access code for international dialing, followed by the country code and phone number.

## Call Using Internet Calling

When Wi-Fi network is available, you can make and receive calls through an Internet calling account.

**Important:** Calling a phone number using Internet calling may incur additional charges.

### Add an Internet Calling Account



1. Press  > **Phone** > **Menu** > **Call settings** > **SIP Accounts** > **ADD ACCOUNT**.
2. Enter your account details and tap **SAVE**.

### Receive Internet Calls

1. Press  > **Phone** > **Menu** > **Call settings** > **SIP Accounts**.
2. Select the **Receive incoming calls** check box.

**Note:** This requires the phone to maintain a connection with a Wi-Fi data network which reduces the life of your phone's battery.

### Make an Internet Call

1. Press  >  > **Contacts**.
2. Tap a contact and then tap **Internet call**.

### Internet Calling Setting

1. Press  > **Phone** > **Menu** > **Call settings** > **Use Internet calling**.
2. Select an option:
  - **For all calls when data network is available** to use Internet calling for all calls when Wi-Fi network is available.
  - **Only for Internet calls** to use Internet calling only for calls to Internet calling addresses.
  - **Ask for each call** to ask each time you make a call.

## Receive Phone Calls

The following information lets you know how to answer incoming calls, mute the ringtone on incoming calls, reject incoming calls, and more.

When you receive a phone call from a contact, the Incoming call screen appears and displays the caller ID icon, name, and phone number of the calling party. When you receive a phone call from someone who is not stored in Contacts, only the default caller ID icon and phone number appear on the Incoming call screen.

**Note:** If your phone is turned off, all calls automatically go to voicemail.

## Answer an Incoming Call

- ▶ On the Incoming call screen, touch and hold  or swipe .

## Mute the Ringing Sound

To mute the ringtone without rejecting the call:

- ▶ Press the volume key down.

## Send an Incoming Call to Voicemail

- ▶ Touch and hold  or swipe  to send the call to your voicemail inbox.

## Reject a Call and Send a Text Message

You can reject an incoming call and automatically send a text message to the caller.

- ▶ Touch and hold  or swipe  to ignore the call and send a message to the caller.

**Note:** You can edit the preset text messages through the Call settings menu. See [Quick Responses](#).

# Voicemail

Your phone automatically transfers all unanswered calls to your voicemail, even if your phone is in use or turned off. Set up your voicemail to access the service.

## Set Up Voicemail

You should set up your voicemail and personal greeting as soon as your phone is activated. See [Set Up Voicemail](#).

## Voicemail Notification

There are a couple of different ways your phone alerts you to a new voicemail message.



- By sounding the assigned notification sound.
- By vibrating the phone when the vibrate setting is on.
- By displaying  within the Notifications area of the Status bar when one or more new voicemail messages are received.

**Note:** Your phone accepts messages even when it is turned off. However, your phone notifies you of new messages only when it is turned on and you are in a network service area.

## *Retrieve Your Voicemail Messages*

You can review your messages directly from your wireless phone or from any other touch-tone phone.

### Use Your Phone to Access Your Messages

1. Press  > **Phone** > **Dialpad**.
2. Touch and hold . If prompted, enter your voicemail password.
3. Follow the voice prompts to listen to and manage your voicemail messages.

### Use Another Phone to Access Messages

1. Dial your wireless phone number.
2. When your voicemail answers, press the asterisk key on the phone (\*).
3. Enter your password.

## *Phone Call Options*

Your phone application provides many useful features and options to help you make the most of your calling experience.

### *In-call Options*

While you're on a call, you will see a number of onscreen options.

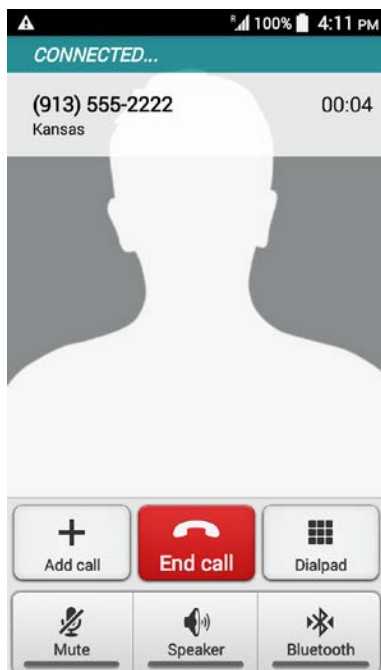

- ▶ Tap an option to select it.
  - **End call:** End the current call.
  - **Add call:** Tap to initiate a 3-way call.
  - **Mute:** Mute or unmute the microphone during an active call.
  - **Speaker:** Turn the speaker on or off.

**Warning:** Because of higher volume levels, do not place the phone near your ear during speakerphone use.

- **Bluetooth:** Route the phone's audio through a connected Bluetooth headset or through the speaker.
- **Dialpad/Hide:** Toggle the appearance of the onscreen dialpad to enter additional numbers such as an extension or access code.
  - For example: When you call your bank's 800 number, use your dialpad to enter your account number and PIN.

## Caller ID

Caller ID identifies a caller before you answer the phone by displaying the number of the incoming call.

To hide your number when you make a call:

1. Press  > **Phone** > **Dialpad**.



2. Enter .
3. Enter a phone number.
4. Tap **Call**.

## Call Waiting

When you're on a call, Call Waiting alerts you to incoming calls by sounding beeps. Your phone screen informs you that another call is coming in and displays the caller's phone number (if available).

To respond to an incoming call while you're on a call:

- ▶ Tap **Call** or swipe . This puts the first caller on hold and answers the second call.

To switch back to the first caller:

- ▶ Tap **Swap calls**.

**Note:** For those calls where you don't want to be interrupted, you can temporarily disable Call Waiting by entering  before placing your call. Call Waiting is automatically reactivated once you end the call.

## Call Waiting Settings

You can customize settings to be notified of a new incoming call while you're on a call.

1. Press  > **Phone** > **Menu** > **Call settings** > **Additional settings**.
2. Select the **Call waiting** check box.

## 3-Way Calling

With 3-way calling, you can talk to two people at the same time. When using this feature, the normal airtime rates will be charged for each of the two calls.

1. Enter a number on the dialpad and tap **Call** (or place a call from Log or Contacts).
2. Once you have established the connection, tap **Add call**, and dial the second number (or place the call from Log or Contacts). This puts the first caller on hold and dials the second number.
3. When you're connected to the second party, tap **Merge calls**. Your conference call is now in session.
4. To end the 3-way call, tap **End call**.





**Note:** If one of the parties you called hangs up during your call, you and the remaining party stay connected. If you initiated the call and are the first to hang up, all parties are disconnected.

## Call Forwarding

Call Forwarding lets you forward all your incoming calls to another phone number – even when your phone is turned off. You can continue to make calls from your phone when you have activated Call Forwarding.

**Note:** You are charged a higher rate for calls you have forwarded.

To activate Call Forwarding:

1. Press  > **Phone** > **Dialpad**.
2. Enter    .
3. Enter the area code and phone number to which you want your calls forwarded.
4. Tap **Call**. You will see the message if the call forwarding is activated.
5. Confirm the message and tap **Forward Calls** to forward your call or tap **Cancel** to cancel forwarding.





To deactivate Call Forwarding:

1. Press  > **Phone** > **Dialpad**.
2. Enter     .
3. Tap **Call**.

## Set Up Speed Dialing

You can store up to 98 numbers in your phone's speed dial memory.

To assign a speed dial number to a contact:

1. Press  >  > **Contacts**.  
– or –  
Press  >  > **Phone** > **Dialpad**.
2. Tap  > **Speed dial setup**.
3. Tap **Add speed dial** next to the location number you want to assign a number to.
4. Select a contact. If the contact has more than one number, select a number.

– or –

1. Press  >  > **Phone** > **Dialpad**.

2. Enter the location number:

For speed dial numbers 2-9, touch and hold the number.

– or –

For speed dial numbers 10-99, tap the first digit and then touch and hold the second digit.

3. Read the message and tap **OK**.

4. Select a contact. If the contact has more than one number, select a number.

To replace a number in a speed dial location:

1. Press  >  > **Contacts**.

– or –

Press  >  > **Phone** > **Dialpad**.

2. Tap  > **Speed dial setup**.

3. Tap the assigned contact you want to replace and tap **Replace**.

4. Select a contact. If the contact has more than one number, select a number.

To delete a number from a speed dial location:

1. Press  >  > **Contacts**.

– or –

Press  >  > **Phone** > **Dialpad**.

2. Tap  > **Speed dial setup**.

3. Tap the assigned contact you want to remove and tap **Remove** > **OK**.

## Recent Calls

The Recent calls tab of the Phone application can list a maximum total of 500 recent incoming, outgoing, and missed calls.

### View Recent Calls

▶ Press  > **Phone** > **Recent calls**.

- You can determine if an entry was an incoming, outgoing, or a missed call from the icons shown below.

 = Incoming Call





 = Outgoing Call

 = Missed Call



## Recent Calls Options

- ▶ To make a call from the Recent calls list, see [Call from Recent Calls](#).

For additional options:



1. Press  > **Phone** > **Recent calls**.
2. Tap  to view the contact.
  - Tap  to send a text message.
  - Tap **Add to contacts** to add the number to Contacts.
  - Tap  > **Delete from recent call** to delete the call.
  - Tap  > **Edit number before call** to edit the number before calling.

## Filter Recent Calls

1. Press  > **Phone** > **Recent calls**.
2. Tap  > **Filter by**.
3. Select **All calls**, **Missed calls**, **Outgoing calls**, or **Incoming calls**.

## Clear Recent Calls

Use the menu option to clear your recent calls.

1. Press  > **Phone** > **Recent calls**.
2. Tap  > **Clear recent calls**.
3. Tap the entry you want to clear to place a check mark in the adjacent box.
4. Tap **Done** > **OK**.

## Call Settings

Your phone's Call settings menu lets you configure your voicemail options and a number of other settings for the Phone application.

### Phone Ringtone

Assign a ringtone to your incoming calls.

1. Press  > **Phone** > **Menu** > **Call settings** > **Phone ringtone**.
2. Tap a ringtone from the list. The ringtone briefly plays when selected.  
– or –  
Tap **Add** and select a sound data.
3. Tap **OK** to assign the ringtone.

### Vibrate When Ringing

Set your phone to ring and vibrate simultaneously.

1. Press  > **Phone** > **Menu** > **Call settings**.
2. Select the **Vibrate when ringing** check box.

### Incoming Call

Select the way to respond to incoming calls.

1. Press  > **Phone** > **Menu** > **Call settings** > **Incoming call**.
2. Select an option:
  - **Swipe** to swipe the available icon to respond to an incoming call.
  - **Tap & hold** to touch and hold the available icon to respond to an incoming call.

### Voicemail Settings

You can configure the voicemail settings.

1. Press  > **Phone** > **Menu** > **Call settings** > **Voicemail**.
2. Configure the following settings:
  - **Service** to select the voicemail service provider.
  - **Setup** to configure the voicemail number, if necessary.
  - **Ringtone** to select the ringtone for a new voicemail message.

- **Vibrate** to select whether the phone responds with vibration to a new voicemail message.



## *Dial Pad Touch Tones*

Play tones when using the dialpad.

1. Press  > **Phone** > **Menu** > **Call settings**.
2. Select the **Dial pad touch tones** check box.

## *Quick Responses*

You can modify the preset text messages to send when you select to reject an incoming call and send a text message.

1. Press  > **Phone** > **Menu** > **Call settings** > **Quick responses**.
2. Tap a message, edit it, and tap **OK**.
  - To restore the default messages, tap  > **Restore defaults**.

## *Fixed Dialing Numbers*

This feature allows you to restrict your outgoing calls to the numbers included in the FDN list. Emergency calls will not be affected by this setting.

To enable FDN mode:

1. Press  > **Phone** > **Menu** > **Call settings** > **Fixed Dialing Numbers**.
2. Tap **Enable FDN**.
3. Enter a PIN2 and tap **OK**.

To change a PIN for FDN access:

1. Press  > **Phone** > **Menu** > **Call settings** > **Fixed Dialing Numbers**.
2. Tap **Change PIN2**.
3. Enter an old PIN2 and tap **OK**.
4. Enter a new PIN2 and tap **OK**.
5. Enter a new PIN2 again and tap **OK**.

To view and manage your FDN list:

1. Press  > **Phone** > **Menu** > **Call settings** > **Fixed Dialing Numbers**.

2. Tap **FDN list**.
  - Tap  > **Add contact** to add a new contact.

## Auto-retry

With Auto-retry enabled, your phone will automatically redial the number it failed to connect to previously.

1. Press  > **Phone** > **Menu** > **Call settings**.
2. Select the **Auto-retry** check box.

## TTY Mode

A TTY (teletypewriter, also known as a TDD or Text Telephone) is a telecommunications device that allows people who are deaf, hard of hearing, or who have speech or language disabilities, to communicate by telephone.

Your phone is compatible with select TTY devices. Please check with the manufacturer of your TTY device to ensure that it supports digital wireless transmission. Your phone and TTY device will connect using a special cable that plugs into your phone's audio jack. If this cable was not provided with your TTY device, contact your TTY device manufacturer to purchase the connector cable.

To turn TTY Mode on or off:

1. Press  > **Phone** > **Menu** > **Call settings** > **TTY mode**.
2. Tap **TTY Full**, **TTY HCO**, or **TTY VCO** to turn TTY mode on.  
– or –  
Tap **TTY Off** to turn TTY mode off.

**Note:** When enabled, TTY mode may impair the audio quality of non-TTY devices connected to the audio jack.

### **Warning:** 911 Emergency Calling

It is recommended that TTY users make emergency calls by other means, including Telecommunications Relay Services (TRS), analog cellular, and landline communications. Wireless TTY calls to 911 may be corrupted when received by public safety answering points (PSAPs), rendering some communications unintelligible. The problem encountered appears related to TTY equipment or software used by PSAPs. This matter has been brought to the attention of the FCC, and the wireless industry and the PSAP community are currently working to resolve this.

## Voice Privacy

You can enable the enhanced privacy mode.

1. Press  > **Phone** > **Menu** > **Call settings**.
2. Select the **Voice privacy** check box.

## Call Restrictions

You can restrict the phone calls your phone can make and receive. Emergency calls will not be affected by this restriction setting.

1. Press  > **Phone** > **Menu** > **Call settings** > **Call restrictions**.
2. Tap **Outgoing calls** or **Incoming calls**.
3. Tap **Allow all**, **Allow contacts**, or **Allow none**.

## DTMF Tones

Follow the steps below if you need to change the DTMF tones.

1. Press  > **Phone** > **Menu** > **Call settings** > **DTMF tones**.
2. Select **Normal** or **Long**.

## Auto Answer

Set your phone to automatically pick up incoming calls. Remember that your phone will answer calls in auto answer mode even if you are not present.

1. Press  > **Phone** > **Menu** > **Call settings** > **Auto answer**.
2. Select **Hands free** or **Speakerphone**.
3. Select the delay time to automatically answer the phone.

## Call Timer

Your phone displays the duration of your last call, outgoing calls, incoming calls, roaming calls, etc.

To view Call Timer:

- ▶ Press  > **Phone** > **Menu** > **Call settings** > **View call timer**.

To reset Call Timer:

1. Press  > **Phone** > **Menu** > **Call settings** > **View call timer**.
2. Touch and hold the item you want to reset and tap **OK**.



**Note:** You cannot reset **Lifetime calls**, which is the total duration of all the calls you have made and received since the activation of the phone.

# Contacts



---

The Contacts application lets you store and manage contacts from a variety of sources, including contacts you enter and save directly in your phone as well as contacts synchronized with your Google Account, your PC, and compatible email programs.

## Contacts List

Scroll through the list to view all your contacts. To see a specific entry, tap it.

▶ Press  >  > **Contacts**.

- **Favorites:** Tap to display your favorite contacts.
- **Contacts:** Tap to display the individual contacts.
- **Groups:** Tap to display the group contacts.
-  : Tap to add a new individual or group contact. See [Add a Contact](#) and [Add a Group Contact](#).
-  : Tap to search a contact.
-  : Tap to display the contacts list options. See [Contacts List Options](#).

**Tip:** You will see letters in alphabetical order when you drag the slider on the right of the screen. Release your finger to display the entries starting with a specific letter when you see it.

## Contacts List Options

Available options vary depending on the selected tab.



▶ Press  >  > **Contacts** > **Favorites** or **Contacts** or **Groups** > .

- **Contacts to display:** Selects contacts to be displayed on Contacts. See [Display Options](#).
- **Speed dial setup:** Opens the Speed dial setup screen.
- **Delete:** Allows you to select and delete the contacts.
- **Import/export:** Imports/exports contacts from/to the microSD card, or shares your visible contacts.
- **Merge contacts:** Moves all contacts to one account. Select the destination account.



- **Accounts:** Enables or disables the auto-sync feature.
- **Settings:** Opens the display settings screen. You can select how your contacts are displayed. See [Display Options](#).
- **Default location:** Selects the default location to save new contacts.
- **Change order:** Allows you to change the order of the listed contacts.

## Display Options

Select which contacts to be displayed on Contacts.



1. Press  >  > **Contacts**.
2. Tap the **Contacts** tab, if necessary.
3. Tap  > **Contacts to display**.
4. Select an account to display its contacts or select one of the following options:
  - **All contacts:** Displays all the contacts you save.
  - **Phone:** Displays the contacts saved in the phone.
  - **Customize:** Allows you to display the selected types of contacts of the selected accounts.

You can also select how your contacts will be displayed.

1. Press  >  > **Contacts** >  > **Settings**.
2. Set the following options:
  - **Sort list by:** Selects how your contacts are sorted.
  - **View contact names:** Selects how your contact's names are displayed.

## Add a Contact



Enter details such as name, phone numbers, email addresses, mailing addresses, and more.

1. Press  >  > **Contacts**.
2. Tap the **Contacts** tab, if necessary.
3. Tap .
4. You may be prompted to select an account to save your new contact to. Select one of the following options:

- Select an account from the displayed list.
  - **Phone:** Stores your contact to your phone.
5. Use the keyboard to enter as much information as you want.
- Tap the location/account above name and select an option to change where to save the contact to.
  - : Tap the picture icon to assign a picture to the contact. See [Assign a Stored Picture to a Contact](#) or [Assign a New Picture to a Contact](#).
  - **Name**
  - **Add organization**
  - **Phone**
  - **Email**
  - **Address**
  - **Phone ringtone**
  - **Message ringtone**
  - **Add another field:** Tap to include additional information such as **Phonetic name**, **IM**, **Notes**, **Nickname**, **Website**, etc.
- Note:** To select a type (label) for a phone number, email address, or postal address (such as **MOBILE**, **HOME**, **WORK**, etc.), tap the type to the right of each field and select the appropriate type.
- Note:** To add more phone numbers, email addresses, etc., tap **Add new** under the current numbers or addresses.
6. When you have finished adding information, tap **Save**.

## Save a Phone Number

You can save a phone number to Contacts directly from the phone dialpad.

1. Press  >  > **Phone** > **Dialpad**.
2. Enter a phone number and tap **Add to contacts**.
3. To add the number to an existing contact, tap the contact, select a number type for the new number, and then tap **OK**.

– or –



To add the number as a new contact, tap **CREATE NEW CONTACT**, enter the name and any additional information, and then tap **Save**. See [Add a Contact](#).

## Edit a Contact

Once you've added a contact, you can add or edit any of the information in the entry, assign a caller ID picture, customize with a unique ringtone, and more.

### Add or Edit Information for a Contact

Follow the instructions to add or edit information for an existing contact.



1. Press  >  > **Contacts**.
2. Tap the **Contacts** tab, if necessary.
3. Tap a contact to display it, and tap  > **Edit**.
4. Tap any field you want to change or add. See [Add a Contact](#).
5. Add or edit the information, and then tap **Save**.

**Note:** To select a type (label) for a phone number, email address, or postal address (such as **MOBILE, HOME, WORK**, etc.), tap the type and select the appropriate type.

**Note:** To add more phone numbers, email addresses, etc., tap **Add new** under the current numbers or addresses.



### Assign a Stored Picture to a Contact

Follow the instructions to assign a picture stored in your phone's internal memory or SD card to a contact.

1. Press  >  > **Contacts**.
2. Tap the **Contacts** tab, if necessary.
3. Tap a contact to display the details and tap the contact icon.
4. Tap **Choose photo from Gallery** and select a location.
5. Tap a picture to select it.
  - You may be prompted to size the picture for use with contacts. Drag the square to frame the portion of the picture to use. Touch and hold the edge of the square and drag it to resize the square and tap **Done** or **SAVE**.



### Assign a New Picture to a Contact

Follow the instructions to take a new picture and assign it directly to an existing contact.

1. Press  >  > **Contacts**.
2. Tap the **Contacts** tab, if necessary.
3. Tap a contact to display the details and tap the contact icon.
4. Tap **Take photo**.
5. Tap  to take a picture.
  - You may be prompted to size the picture for use with contacts. Drag the square to frame the portion of the picture to use. Touch and hold the edge of the square and drag it to resize the square and tap **Done** or **SAVE**.



### Assign a Phone Ringtone to a Contact

Know who's calling without looking at your phone by assigning a specific ringtone to a contact.

1. Press  >  > **Contacts**.
2. Tap the **Contacts** tab, if necessary.
3. Tap a contact to display the details and tap the current ringtone under PHONE RINGTONE.
4. Tap a ringtone from the list. The ringtone briefly plays when selected.
  - or –
  - Tap **Add** and select a sound data.
5. Tap **OK** to assign the ringtone.



### Assign a Message Ringtone to a Contact

Know the sender of the new message from a specific ringtone.

1. Press  >  > **Contacts**.
2. Tap the **Contacts** tab, if necessary.
3. Tap a contact to display the details and then tap the current ringtone under MESSAGE RINGTONE.
4. Tap a ringtone from the list. The ringtone briefly plays when selected.
  - or –
  - Tap **Add** and select a sound data.
5. Tap **OK** to assign the ringtone.





## Assign a Vibration to a Contact

You can assign a specific vibration pattern to a contact.

1. Press  >  > **Contacts**.
2. Tap the **Contacts** tab, if necessary.
3. Tap a contact to display the details and tap  > **Set vibrate**.
4. Tap an available vibration. The phone vibrates when selected.
5. Tap **OK** to assign the vibration.





## Add a Contact to Favorites

The Favorites tab of the Phone menu is a listing that can help you quickly access your most used or preferred contacts entries.

1. Press  >  > **Contacts**.
2. Tap the **Contacts** tab, if necessary.
3. Tap a contact to display the details and tap . The icon changes to  when the contact is added to Favorites.



## Send a Contact's Call to Voicemail

You can transfer your contact's voice call to voicemail anytime you receive it.

1. Press  >  > **Contacts**.
2. Tap the **Contacts** tab, if necessary.
3. Tap a contact to display the details and tap .
4. Check the **All calls to voicemail** check box.  appears next to **PHONE** on the Contact details screen.



## Add a Contact Widget to the Home Screen

You can place your favorite contacts on the Home screen.

1. Press  >  > **Contacts**.
2. Tap the **Contacts** tab, if necessary.
3. Tap a contact to display the details and tap  > **Place on Home screen**. The contact widget is added to your Home screen.

## Delete a Contact



You can delete a contact from the contacts details page.

1. Press  >  > **Contacts**.
2. Tap the **Contacts** tab, if necessary.
3. Tap a contact to display the details and tap  > **Delete**.
4. Tap **OK**.

## Add a Group Contact

Create a group contact with your individual contact entries in Contacts.

**Note:** In order to create a group contact, you may first sync your phone with a Google or corporate account. See [Synchronize Contacts](#) for instructions on how to sync your phone to an account.

1. Press  >  > **Contacts**.
2. Tap the **Group** tab, if necessary.
3. Tap .
4. Select the account in which you want to create a group contact.
5. Enter the group's name.
6. Tap **Add new** and tap the entries you want to add.



**Tip:** You can tap  to search an entry in your Contacts or tap **CREATE NEW CONTACT** to create a new entry.

7. Tap **Done** > **Save**.

## Edit a Group Contact

Manage the group contacts that you have created.

### Add or Remove a Group Contact Entry, or Rename a Group



1. Press  >  > **Contacts**.
2. Tap the **Group** tab, if necessary.
3. Tap a group contact and tap  > **Edit**.
4. The following options are available:



- Tap the group's name to rename it.
- Tap **Add new** to add an entry to the group.
- Tap  next to the entry you want to remove from the group.

5. Tap **Save**.



### Delete a Group Contact

1. Press  >  > **Contacts**.
2. Tap the **Group** tab, if necessary.
3. Tap a group you want to delete and tap  > **Delete**.
4. Tap **OK**.



## ICE (In Case of Emergency)

Registering ICE information might help rescue workers such as paramedics, police, and hospital personnel identify your primary contact. You can register up to three contacts.



### Register an ICE Contact

1. Press  >  > **Contacts**.
2. Tap the **Contacts** tab, if necessary.
3. Tap **ICE - In Case of Emergency** > .
4. Tap the entry you want to register.

### Remove an ICE Contact



1. Press  >  > **Contacts**.
2. Tap the **Contacts** tab, if necessary.
3. Tap **ICE - In Case of Emergency** > .
4. Tap the contact you want to remove > **OK**.

### Enter or Edit Your Own Information

1. Press  >  > **Contacts**.
2. Tap the **Contacts** tab, if necessary.
3. Tap **ICE - In Case of Emergency** > **My emergency information** > .

4. Enter or edit the necessary information and tap **Save**.



### Access the Registered ICE Information When the Screen is Locked

1. Tap  on the screen.
2. The following options are available:
  - Tap **My emergency information** to display the registered information.
  - Tap  next to the ICE contact to place a call to the contact.

## Synchronize Contacts

Syncing data from your managed accounts lets you add and manage new or existing contacts from your online or remote accounts to your phone. Prior to syncing, you must have an active Google or corporate account with associated contacts and be signed into your account with the phone.

With syncing, any contacts (with phone numbers, email addresses, pictures, etc.) are updated and synced with your phone.

1. Press  >  > **Settings**.
2. Tap **Corporate**, **Google**, etc. under ACCOUNTS.
3. Tap the account you want to sync your contacts with.
4. Select the **Contacts** check box.



**Note:** The process of updating your contacts tab can take several minutes. If your list has not been updated after 10-20 minutes, repeat steps 3 and 4.

Your Contacts then reflects any updated contact information.

- This update process works both ways. For example, any changes on the phone are updated to your Gmail contacts list after sync and vice versa.

## Share a Contact

You can quickly share contacts using Bluetooth, Email, Gmail, or Messaging.

1. Press  >  > **Contacts**.
2. Tap a contact to display the details and tap  > **Share**.
3. In the **Share contact via** menu, select a method and follow the onscreen instructions. You can see some of the examples to share your contact below:

- **Bluetooth** to send the information via Bluetooth. See [Bluetooth](#) for information on pairing and sending via Bluetooth.
- **Drive** to send the information to Google Drive. Confirm or edit the document title, the account, and the folder to save the document and then tap OK.
- **Email** to send the information as an email attachment. See [Send an Email Message](#) for details on sending email.
- **Gmail** to send the information as a Gmail attachment. See [Send a Gmail Message](#).
- **Messaging** to send the information as an attachment to a message. See [Send a Multimedia Message \(MMS\)](#).

# Accounts and Messaging

---

With U.S. Cellular service and your phone's messaging capabilities, you have the opportunity to share information through many different channels and accounts, including Gmail (Google), personal and corporate email, text and multimedia messaging, and social networking accounts.

## Gmail / Google

You will need a Google Account to access several phone features such as Gmail, Google+, and the Google Play Store applications. Before you are able to access Google applications, you must enter your account information. These applications sync between your phone and your online Google Account.

### Create a Google Account





If you do not already have a Google Account, you can create one online or using your phone.

**Note:** Although you need a Gmail account to use certain features on your phone, such as Google Play Store, you do not need to use Gmail as the default account for your phone.

#### Create a Google Account Online

1. From a computer, launch a Web browser and navigate to [google.com](http://google.com).
2. On the main page, click **Sign in > Create an account**.
3. Follow the onscreen prompts to create your free account.

#### Create a Google Account Using Your Phone



1. Press  >  > **Settings > Add account > Google > New**.
2. Enter your first name and last name, and tap .
3. Enter a desired username and tap .
4. When prompted, enter and reenter a password and tap .
5. Select if you set up recovery options now.

**Note:** When setting up a new Google Account, either on your phone or online, you are recommended to add a secondary phone number or email address. Enter a second phone number or email address from which you currently send and receive message or email. This number or address is used to authenticate your account should you ever encounter problems or forget your password. It is strongly encouraged for Android users so you can regain access to Google Mobile™ services and purchases on your phone.

6. Select the **BACKUP & RESTORE** and **COMMUNICATION** options, if prompted, and tap ►.
7. Tap **I accept** if you agree to the Google Terms of Service and Privacy Policy, Chrome Terms of Service and Privacy Notice, and Google Play Terms of Service. Tap underlined items to read them.
8. Type the displayed texts for authentication and tap ►.
9. Select if you will join Google+ now.
10. Select if you will save your credit card information now or later to enable purchases at Google Play Store. Your account is displayed in **Google** under **ACCOUNTS** in the Settings menu.



## Sign In to Your Google Account

If you have a Google Account, but have not yet signed in with your phone, follow these instructions to sign in to your Google Account.

1. Press  >  > **Settings** > **Add account** > **Google** > **Existing**.
2. Enter your Gmail username and password, and tap ►.
3. Read the message, and tap **OK**.
4. Select if you will join Google+ now, if prompted.
5. Select the **BACKUP & RESTORE** and **COMMUNICATION** options, if prompted, and tap ►.
6. Select if you will save your credit card information now or later to enable purchases at Google Play Store or enter redeem information.
7. Select the items you would like to sync with your phone, if prompted, and tap ►. Your account is displayed in **Google** under **ACCOUNTS** in the Settings menu.

## Access Gmail



Access your personal Gmail account directly on your phone.

1. Press  >  > **Gmail**.
2. Do any of the following:
  - View more email messages: If the inbox is full, swipe your finger up the screen to view more messages and conversations.
  - Read a new email message: Tap the unread message or the conversation with an unread message (just-arrived items displayed in bold).

- Select messages and conversations: Tap the box next to the email or conversation.
- View the inbox of your other Gmail account:
  - Tap the account name at the top of the screen, and then tap the account you want to view.
- Refresh the inbox: Tap  > **Refresh**.

## Send a Gmail Message

Use your phone to send Gmail messages.



1. Press  >  > **Gmail** > .
2. Enter the message recipient's email address in the **To** field. If you are sending the email message to several recipients, separate the email addresses with a comma. As you enter email addresses, any matching addresses from your contacts list are displayed. Tap a match to enter that address directly.

**Tip:** You can enter a name saved in **Contacts** to call up the email address. Tap a match from an available list.

3. If you want to send a carbon copy (Cc) or a blind carbon copy (Bcc) of the email to other recipients, tap  > **Add Cc/Bcc**.
4. Enter the subject, and then compose your email.

**Note:** If you want to attach a picture, tap  > **Attach file**. Locate and tap the picture you want to attach.

5. After composing your message, tap .

**Note:** While composing the message, tap  > **Save draft** to save it as a draft. To view your draft messages, tap the account name next to  at the top of the folder screen and tap **Drafts**.





**Note:** To view your sent messages, tap the account name next to  at the top of the folder screen and tap **Sent**.

## Read and Reply to Gmail Messages

Your phone allows you to access, read, and reply to all your Gmail messages.

1. Press  >  > **Gmail**.
2. Tap a message to display it.

**Tip:** You can also access new messages through the Notifications panel. When a new Gmail message arrives, you'll see the  icon in the status bar. Slide the bar down to display notifications. Tap a message to display it.

3. To reply to or forward a message:
  - Tap  to reply to the sender of the message.
  - Tap  > **Reply all** to reply to all recipients of the message.
  - Tap  > **Forward** to forward the message.
4. After composing your message, tap .

## Email



Use the Mail application to send and receive email from your webmail or other accounts, using POP3 or IMAP, or access your Exchange ActiveSync account for your corporate email needs.

### Add an Email Account

You can add several types of personal email accounts, such as POP3 and IMAP accounts, on your phone.

1. Press  >  > **Settings** > **Add account** > **Email**.

– or –

Press  >  > **Email**, if you have not set up any email account yet.

2. Enter your email address and password and tap **Next**.
3. Enter any other necessary information and follow the onscreen instructions.

**Important:** If the account type you want to set up is not in the phone database, you will be asked to enter more details. You should get all pertinent information for the email account, such as incoming and outgoing server settings, before you proceed.

### Add a Corporate Account

If you synchronize your phone with your corporate account, you can read, manage, and send email in the same easy way as with a POP3/IMAP account. You can also access some powerful Exchange features.

**Note:** Before setting up a Microsoft® Exchange ActiveSync® account, contact your company's Exchange Server administrator for required sign-in information.

1. Press  >  > **Settings** > **Add account** > **Corporate**.

– or –

Press  >  > **Email**, if you have not set up any email account yet.

2. Enter the **Email address** and **Password** information and then tap **Next**. Consult your network administrator for further details:
  - **Email address:** your corporate email address.
  - **Password:** typically your network access password (case-sensitive).
3. Enter the **Username**, **Password**, **Server**, **Domain**, and **Port** information:
  - **Username:** enter your network login username.
  - **Password:** typically your network access password (case-sensitive).
  - **Server:** your Exchange server remote email address. Typically it is in the form of mail.XXX.com. Obtain this information from your company's network administrator.
  - **Domain:** enter your network domain.
  - **Port:** modify the port number if necessary.
4. If your network requires SSL encryption, select the **SSL/TLS** from the dropdown list and activate this additional level of security. If your Exchange server requires this feature, leaving this field unconfigured can prevent connection.
5. Tap **Next**.
6. If the onscreen activation disclaimer is displayed, tap **OK**.
7. Configure your **Inbox checking frequency**, **Days to sync** (days to synchronize between your phone and server), and activate any other email settings, and then tap **Next**.

**Note:** Signal interruptions or incorrect user name or password information can cause completion issues.

8. Identify your new account with a unique name and tap **Next**.

**Note:** You can have multiple corporate email (Microsoft Exchange ActiveSync) accounts active on your phone.

## *Send an Email Message*

Compose and send email messages using any account you have set up on your phone. Increase your productivity by attaching files such as pictures and videos to your email messages.

1. Press  >  > **Email** > .







**Tip:** Tap the account name at the top of the screen to switch to a different email account.

2. Enter email addresses directly in the **To** field. If you're sending the email to several recipients, separate the email addresses with a comma. As you enter email addresses, any matching addresses from your contacts list are displayed. Tap a match to enter the address directly.

**Tip:** You can enter a name saved in Contacts to call up the email address, or tap  to access your Contacts.



**Tip:** If you want to send a CC or a BCC of the email to other recipients, tap  > **Add Cc/Bcc**.

3. Enter the subject, and then compose your message.
4. To add an attachment, tap  > **Attach file**, and choose from the following options:
  - **Pictures:** Select photos.
  - **Take picture:** Take a new picture.
  - **Videos:** Select videos.
  - **Record video:** Record a new video.
  - **Audio:** Select sound files.
  - **Others:** Select other files.
5. Tap  to send the message.

**Note:** While composing the message, tap  > **Save draft** > **Yes** to save it as a draft. To view your draft messages, tap the account name next to  at the top of the folder screen and tap **Drafts**.



## View and Reply to Email

Reading and replying to email on your phone is as simple as on your computer.

1. Press  >  > **Email**.
  - If Inbox is not displayed, tap the account name next to  at the top of the screen and tap **Inbox**.
2. Tap the message you want to view.

**Tip:** Tap the account name next to  at the top of the screen to switch to a different email account.

3. To reply to or forward a message:

- Tap  to reply to the sender of the message.
- Tap  to reply to all recipients of the message.
- Tap  to forward the message.

4. After composing your message, tap .

## Manage Your Email Inbox

Your email inbox provides management options for viewing, sorting, and deleting your email messages.

### View Your Email Inbox

▶ Press  >  > **Email**.

- If Inbox is not displayed, tap the account name next to  at the top of the screen and tap **Inbox**.

### Refresh an Email Account

Whatever your automatic synchronization settings are, you can also synchronize your sent and received email messages manually at any time.



▶ While viewing the account you want to synchronize, tap  > **Refresh**.

### Delete Email Messages

1. On the email account Inbox, tap the box next to the message(s) you want to delete.
2. Tap .

## General Email Settings



You can edit the general settings of your email.

1. Press  >  > **Email** >  > **Settings**.
2. Tap **General settings**:
  - **Set default account:** Select an account to set as default.
  - **Confirm before deleting:** Check to display a confirmation before deleting a message.
  - **Confirm before sending:** Check to display a confirmation before sending a message.
  - **Auto-advance:** Choose which screen to show after you delete a message.

- **Sender image:** Check to display an image of the sender in conversation list.
- **Swipe to delete:** Check to delete a message in conversation list by swiping it.
- **View type of the mail list:** Select the way to display the mail list.
- **Message format:** Select a format to use for messages.
- **Storage for attachment:** Select where to save attachment.
- **Default image size:** Select the size of the image files to attach to your message.
- **Exchange errors log:** Check to save the Exchange ActiveSync error logs.

## *Email Account Settings*

You can edit settings for your individual email accounts, such as email address and password, name display and signature, frequency of retrieval, and more.

1. Press  >  > **Email** >  > **Settings**.
2. Select the email account you want to edit.
3. Set the following options (options vary depending on the type of account):
  - **Account name:** Edit your account name.
  - **Your name:** Edit your name displayed on your emails.
  - **Signature:** Create an email signature for your outgoing emails.
  - **Quick responses:** Edit the text you frequently insert when composing emails.
  - **Inbox view:** Select how the inbox is displayed with **Normal view** and **Conversation view**.
  - **Security options:** Enable security options such as encrypting outgoing messages with attachments and attaching a digital signature to outgoing messages.
  - **Clear email address history:** Clear all email addresses of composed emails in the prediction list.
  - **Sync frequency:** Set the frequency to synchronize your account.
  - **Enable Peak-Time:** Set the two sets of time intervals to check your new emails – one for peak time and the other for off peak-time.
    - **Frequency during Peak-Time:** Select the time interval used by your phone to check your new emails during peak time.

- **Frequency during Off Peak-Time:** Select the time interval used by your phone to check your new emails during off peak time.
  - **Peak-Time schedule:** Set a period of time to assign it as peak time to suit your needs.
- **Days to sync:** Set a period of time to synchronize your account.
  - **Sync email:** Check to synchronize your email.
  - **Sync contacts:** Check to synchronize your contacts.
  - **Sync calendar:** Check to synchronize your calendar.
  - **Sync task:** Check to synchronize your task.
  - **Sync note:** Check to synchronize your note.
  - **Sync SMS:** Check to synchronize your SMS.
  - **Download attachments:** Check to automatically download attachments via Wi-Fi.
  - **Download over Wi-Fi only:** Check to allow downloads of attachments over Wi-Fi only.
  - **Email notifications:** Check to display the email notification icon on the status bar when a new mail is received.
  - **Choose ringtone:** Select a ringtone for new email messages.
  - **Vibrate:** Check to vibrate a phone when a new email is received.
  - **Incoming settings:** Adjust the incoming email parameters such as username, password, and other incoming connection parameters (ex: IMAP server).
  - **Out of office settings:** Set your current status and your message to reply automatically while you are out of the office.
  - **Mail size limit:** Set the limit to partially download emails. If you want to download the rest of the message, tap **View entire email** which appears below the partially downloaded message.
  - **Outgoing settings:** Adjust the outgoing email parameters, such as username, password, and other outgoing connection parameters (ex: SMTP server).

## *Text and Multimedia Messaging*



With Text Messaging (SMS), you can send and receive instant text messages between your wireless phone and another messaging-ready phone.

Multimedia messages, or MMS, can contain text and pictures, audio or video files, picture slideshows, contact cards (vCard), or appointments (vCalendar).

See your service plan for applicable charges for messaging.

## Send a Text Message

Quickly compose and send text messages on your phone.



1. Press  >  > **Messaging**.
2. On the Messaging screen, tap . The Compose screen opens.
3. Fill in one or more recipients. You can:
  - Enter phone numbers or email addresses in the **To** field. If you're sending the message to several recipients, separate the phone numbers or email addresses with a comma. As you enter information, any matching phone numbers or addresses from your contacts list are displayed. Tap a match to enter that number or address.

**Tip:** You can enter a name saved in Contacts to call up the email address, or tap  to access your Contacts.

4. Tap the **Type message** field and then start composing your message.
5. When done, tap  to send the text message.

## Send a Multimedia Message (MMS)

When you need to add a little more to a text message, you can send a multimedia message (MMS) with pictures, audio or video files, or slideshows.

1. Press  >  > **Messaging**.
2. On the Messaging screen, tap . The Compose screen opens.
3. Fill in one or more recipients. You can:
  - Enter phone numbers or email addresses in the **To** field. If you're sending the message to several recipients, separate the phone numbers or email addresses with a comma. As you enter information, any matching phone numbers or addresses from your contacts list are displayed. Tap a match to enter that number or address.

**Tip:** You can enter a name saved in Contacts to call up the email address, or tap  to access your Contacts.

4. Tap the **Type message** field and then start composing your message.
5. Tap  and select from the following file attachments:



- **Pictures:** Select a stored picture to attach.
- **Capture picture:** Take a picture to attach.
- **Videos:** Select a stored video to attach.
- **Capture video:** Record a video to attach.
- **Audio:** Select an audio file to attach.
- **Record audio:** Record an audio file to attach.
- **Slideshow:** Edit a slideshow to attach. See [Create a Slideshow](#) for details.
- **Contact (vCard):** Select a contact entry or contact entries to attach.
- **Event (vCalendar):** Select an event entry to attach.

**Tip:** To remove an attachment, tap .

6. When done, tap  to send the Multimedia message.

## Create a Slideshow



In a multimedia message, you can add slides, each containing a picture, video, or audio.

1. In the multimedia message you're composing, tap  > **Slideshow**.
2. To compose your slideshow, do any of the following:
  - Tap **Add slide** to create a new slide. (This is a placeholder for new images to be added, similar to a playlist.)
  - Tap the created slide (example, Slide 1), tap **Add picture**, and select the picture you want to add to the slide.
  - Tap the **Type message, or leave blank** field to add a caption.
  - Tap **Preview** to preview the slide, **Replace picture** to delete the currently selected picture, or **Remove slide** to remove the selected slide.
  - Tap  for more options such as adding another picture, capturing a new picture, or adding music.
3. Tap **Return** to attach the slide to the message and go back to the message composing screen.
4. When you have finished composing the multimedia message, tap .

## Save and Resume a Draft Message



While composing a text or multimedia message, press  > **Yes** to save your message as a draft.

To resume composing the message:

1. Press  >  > **Messaging**.
2. On the Messaging screen, tap the message to resume editing. “Draft” in red appears to the right of the message on the list.
3. When you finish editing the message, tap .

## New Messages Notification

Depending on your notification settings, the phone will play a ringtone, vibrate, or display the message briefly in the status bar when you receive a new text or multimedia message. To change the notification for new text and multimedia messages, see [Text and MMS Options](#) for details.

A new message icon  also appears in the notifications area of the status bar to notify you of a new text or multimedia message. The Messages application icon (if shown on the Home screen) also displays the number of new messages .

To open the message, slide the status bar down to open the Notifications panel. Tap the new message to open and read it. For information on reading and replying to messages see [Manage Message Conversations](#).

## Manage Message Conversations

Text and multimedia messages that are sent to and received from a contact (or a number) are grouped into conversations or message threads in the Messaging screen. Threaded text or multimedia messages let you see exchanged messages (similar to a chat program) with a contact on the screen.

### Read a Text Message

- ▶ Do one of the following:
  - On the Messaging screen, tap a thread to open and read the messages in the thread.
  - If you have a new message notification, drag the status bar down to open the Notifications panel. Tap the new message to open and read it.

To return to the Messaging screen from a text message thread, press .



**Note:** To view the details of a particular message, in the message thread, touch and hold the message to open the options menu, and then tap **View details**.

**Note:** If a message contains a link to a Web page, tap the message to open the linked page in the Web browser.

**Note:** If a message contains a phone number, tap the message to dial the number or send a text message, or touch and hold the message to add it to your contacts.

**Note:** If a message contains an email address, tap the message to compose a new email message or a text message.



## View a Multimedia Message (MMS)

1. Press  >  > **Messaging**.
2. On the Messaging screen, tap a multimedia message or message thread to open it.
3. Tap the attachment to open it.
4. To save the attachment to the storage card, touch and hold the message and then tap **Save attachment** on the options menu.

**Note:** When **Auto-retrieve** in MMS settings is disabled, only the message header is downloaded. To download the entire message, tap the **Download** button. For details, see [Text and MMS Options](#).



**Note:** If you are concerned about the size of your data downloads, check the multimedia message size before you download it.

## Reply to a Message

1. Press  >  > **Messaging**.
2. On the Messaging screen, tap a text or multimedia message thread to open it.
3. Tap the text box at the bottom of the screen, enter your reply message, and then tap .

**Note:** To reply to a text message with a multimedia message, open the text message and tap . The text message is automatically converted into a multimedia message.



## Delete a Message Thread

1. Press  >  > **Messaging**.
2. On the Messaging screen, touch and hold the message thread that you want to delete. The thread is highlighted and the number of the selected thread appears next to **Choose conversations**. Tap another thread to select multiple threads.
3. Tap .





4. When prompted to confirm, tap **Delete**.





### Delete All Message Threads

1. Press  >  > **Messaging**.
2. On the Messaging screen, tap  > **Delete all threads**.
3. Tap **Delete**.

### Delete a Single Message

1. Press  >  > **Messaging**.
2. Tap a thread containing the message you want to delete.
3. Touch and hold the message to display the Message options window.
4. Tap **Delete**.
5. When prompted to confirm, tap **Delete**.

### Delete Multiple Messages



1. Press  >  > **Messaging**.
2. Tap a thread containing the message you want to delete.
3. Tap  > **Delete Message** > **Choose message(s)**.
  - Select **All messages** to delete all messages in the thread.
4. Tap the message you want to delete. The message is highlighted and the number of the selected message appears next to **Choose message(s)**. Tap another message to select multiple messages.
5. Tap .
6. When prompted to confirm, tap **Delete**.

### View Contact Information from a Message

When you have received a message from someone in your stored contacts, you can tap the contact's picture in the message thread to open a menu of options. Depending on the stored contact information, you can view the contact details, phone or send an email message to the contact, and more.

## Text and MMS Options

The messages settings menu lets you control options for your text and MMS messages including message limits, size settings, and notifications.

1. Press  >  > **Messaging**.
2. On the Messaging screen, tap  > **Settings**. You can set the following:
  - **SMS Enabled:** Select your default SMS app. See [Default SMS App](#) for details.
  - STORAGE
    - **Delete old messages:** Automatically delete older messages when the set limits are reached.
    - **Text message limit:** Choose the maximum number of text messages to store in each conversation thread.
    - **Multimedia message limit:** Choose the maximum number of Multimedia messages to store in each conversation thread.
    - **Preset message:** Edit or create the text you frequently insert when composing messages.
  - MULTIMEDIA (MMS) MESSAGES
    - **Group messaging:** Use MMS to send a single message when there are multiple recipients.
    - **Auto-retrieve:** Automatically retrieve all your multimedia messages completely. When selected, the multimedia message header plus the message body and attachments will automatically download to your phone. If you clear this check box, only the multimedia message header will be retrieved and shown in your Messaging screen.
      - **Roaming auto-retrieve:** Select this option to automatically retrieve all your messages completely when roaming. This may incur significant phone charges.
    - **Creation mode:** Select **Restricted** if you want to restrict the specifications of the file you can send as an attachment.
  - NOTIFICATIONS
    - **Notifications:** Select this option if you want to receive a notification in the status bar when a new text or multimedia message arrives.

- **Sound:** Select a ringtone that is specific to new text and multimedia messages. Note that the ringtone briefly plays when selected.
- **Vibrate:** Select this option if you want the phone to vibrate when a new text or multimedia message arrives.



**Tip:** To restore the default settings, tap  > **Restore default settings.**

## Social Networking Accounts

Stay in touch while on the go with all your social networking accounts.

### Google+

With Google+, you can check your friends' updates, post updates of your own, and chat with friends in your Google+ circles.

1. Press  >  > **Google+.**
  - Sign in to your Google Account with your existing or new account, if you have not signed in to it yet.
  - Select an account you want to use with Google+ if you are signed in to more than one Google Account on your phone.
2. Follow the onscreen instructions.

### YouTube

YouTube™ is a video sharing website on which users can upload and share videos. The site is used to display a wide variety of user-generated video content, including movie clips, TV clips, and music videos, as well as video content such as video blogging, informational shorts and other original videos.

#### Open YouTube

- ▶ Press  >  > **YouTube.**

**Note:** **Terms of Service** may appear. Tap **Accept**, if you agree to the Terms of Service.

#### Watch YouTube Videos

1. On the YouTube screen, tap a video.
2. Tap the screen to show the progress bar at the bottom. Tap the screen while the bar is displayed to pause/play the video. Move the slider on the bar to the left or right to rewind or fast-forward the video.

## Search for Videos

1. On the YouTube screen, tap  on the screen to open the search box.
2. Enter the keyword to search. Search results appear below the status bar.
3. Tap a video to watch it.

# Apps and Entertainment

---

All your phone's features are accessible through the Apps list.

**Note:** Available applications and services are subject to change at any time.



## Google Play Store App

Google Play™ is your digital content destination to discover Android apps, books, movies, music, and much more on your phone and on the web. Choose from a wide variety of free and paid content ranging from productivity apps and games to bestselling books and blockbuster movies and music. When you find what you want, you can easily download and install it on your phone.

To access the Google Play Store app, you must first connect to the Internet using your phone's Wi-Fi, 4G, or data connection and sign in to your Google Account. See [Web and Data](#) and [Sign In to Your Google Account](#). Your Google Play Store app will update automatically when available.

## Find and Install an App

When you install apps from the Google Play Store app and use them on your phone, they may require access to your personal information (such as your location, contact data, and more) or access to certain functions or settings of your phone. Download and install only apps that you trust.

1. Press  >  > **Play Store**.
2. When you open the Google Play Store app for the first time, the Terms of Service window will appear. Tap **Accept** to continue.
3. Find an app you want and tap it to open its details screen.

**Tip:** Tap  to add the app to your wishlist for future reference.

4. Tap **INSTALL** (for free applications) or the price button (for paid applications).

**Note:** You need a Google Wallet account to purchase items on Google Play. See [Create a Google Wallet Account](#) to set up a Google Wallet account if you do not have one.

5. The subsequent screen notifies you whether the app will require access to your personal information or access to certain functions or settings of your phone. If you agree to the conditions, tap **ACCEPT** to begin downloading and installing the app.

If you selected a paid application, after tapping **ACCEPT**, follow the onscreen instructions to add a payment method and complete your purchase.

**Warning:** **Read the notification carefully!** Be especially cautious with applications that have access to many functions or a significant amount of your data. Once you tap **ACCEPT** on this screen, you are responsible for the results of using this item on your phone.

## Create a Google Wallet Account

Create a Google Wallet account associated with your Google Account to purchase items from the Google Play Store app.

Do one of the following:

- ▶ On your computer, go to [wallet.google.com](https://wallet.google.com) to create a Google Wallet account.

– or –

The first time you use your phone to buy an item from Google Play, you're prompted to enter your billing information to set up a Google Wallet account.



**Warning:** When you've used Google Wallet once to purchase an application from the Google Play Store app, the phone remembers your password, so you don't need to enter it the next time. For this reason, you should secure your phone to prevent others from using it without your permission. (For more information, see [Lock Screen Settings and Security Settings](#).)

## Google Play Store Options

Some convenient options are available with the Google Play Store app. Available options may vary.

- ▶ In the Google Play Store app, tap  on the top left of the screen to display the following options:

**Tip:** You can also touch and hold the left end of the screen and slide it to the right to display the options.



- The account name you are currently logged in to the Google Play Store app is displayed. To log in with another account stored on your phone, tap  next to the account name and select an account.
- **Store home** returns to the Google Play Store homepage.
- **My apps** displays the lists of apps stored on your phone.
- **Shop apps** displays the Apps Home screen.
- **My wishlist** displays the apps you have bookmarked. To bookmark an app, tap the bookmark icon  on the apps detailed screen.

**Note:** Tap **REDEEM**, **SETTINGS**, or **HELP** for additional options.

## Request a Refund for a Paid App



If you are not satisfied with an app, you can ask for a refund within 15 minutes of the purchase, unless otherwise stated by the app developer. Your credit card is not charged and the app is uninstalled from your phone.

If you change your mind, you can install the app again, but you can't request a refund a second time.



1. Press  >  > **Play Store**.
2. Tap  on the top left of the screen, or touch and hold the left end of the screen and slide it to the right, and tap **My apps**.
3. Tap the app to uninstall for a refund. The details screen for the app opens.
4. Tap **Refund**. Your app is uninstalled and the charge is cancelled.

## Open an Installed App



There are options for opening an installed app.

- ▶ On the status bar, check if you see the  icon. If you see the  icon, open the Notifications panel, and then tap the app to open it.

– or –

1. Press  > .
2. Locate the app and tap the icon.

– or –

1. Press  >  > **Play Store**.
2. Tap  on the top left of the screen, or touch and hold the left end of the screen and slide it to the right, and tap **My apps**.
3. Locate the app and tap the icon.
4. Tap **OPEN**.



## Uninstall an App

You can uninstall any app that you have downloaded and installed from the Google Play Store app.

1. Press  >  > **Play Store**.

2. Tap  on the top left of the screen, or touch and hold the left end of the screen and slide it to the right, and tap **My apps**.
3. Tap the app you want to uninstall, and tap **UNINSTALL**.
4. When prompted, tap **OK** to remove the app from your phone.

– or –

1. Press  >  > **Settings** > **Apps**.
2. Tap the **DOWNLOADED** tab, tap the app you want to uninstall, and tap **Uninstall**.
3. When prompted, tap **OK** to remove the app on your phone.

## Navigation

Your phone offers a number of location-based navigation programs to help you figure out where you are and get you where you're going.

**Note:** You may be asked or redirected to enable your phone's location features for using location-based apps, if you have not enabled them yet. See [Location Settings](#).



## Google Maps

Use the Google Maps app to determine your location, find directions, browse local businesses and attractions, rate and review places, and more.

### Enable Location Services on Your Phone

Before using any location-based services, you must enable your phone's GPS location feature. See [Location Settings](#).

### Open Google Maps

- ▶ Press  >  > **Maps**.

**Note:** When you open the Google Maps apps for the first time, the Welcome to Google Maps screen will appear. Tap **Accept & continue** if you agree to the Terms of Service and Privacy Policy.



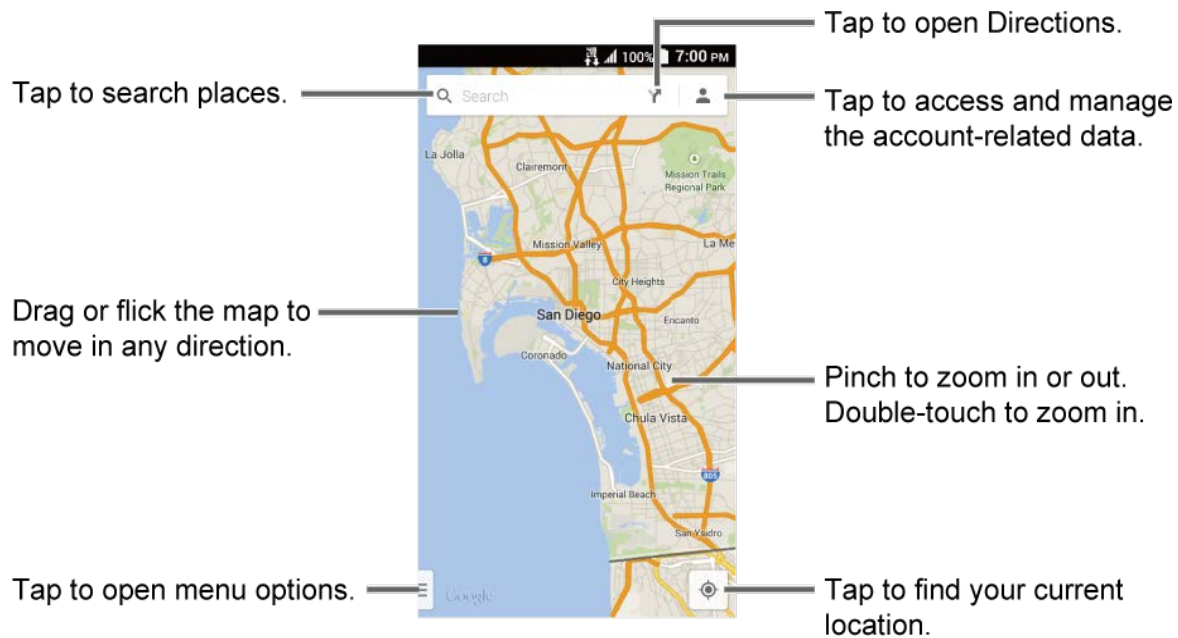

## Find Your Current Location

**Note:** Don't forget to set your location sources.

On the Google Maps screen, tap . A blinking blue arrow indicates your current location on the map. This feature is available when the location setting is enabled. See [Location Settings](#).

## Search Maps

1. On the Google Maps screen, tap .
2. Type the place that you want to search. You can enter an address, a city, or type of establishment.

**Tip:** Tap  to enter the location by speaking.

3. Tap a matching result on the drop-down list or tap  on the keyboard. A red marker appears on the map, to indicate the location, together with a label at the bottom of the screen.
4. Tap the marker or the label to open the menu for the location.

## Add Map Layers

Layers allow you to view locations and additional information overlaid on the map. Some of the layers are available only in selected areas.

- ▶ On the Google Maps screen, tap  at the bottom left of the screen or touch and hold the left end of the screen and slide it to the right:



- **Traffic:** Provides real-time traffic information. The colors on the roads indicate the traffic conditions.
- **Public Transit:** Provides available transit information.
- **Bicycling:** Provides possible cycling routes.
- **Satellite:** Provides the hybrid view of road labels overlaid on a satellite image.
- **Terrain:** Provides the shaded relief view of topographic features.
- **Google Earth:** Launches the Google Earth app and displays your location in Google Earth.

**Note:** Tap **Settings**, **Help**, **Send feedback**, or **Tips and Tricks** for additional options.

## Get Directions

1. On the Google Maps screen, tap .
2. Specify the starting point and the destination:

**Tip:** Tap  and enter your home and work addresses on the Google Maps screen to display them as options.

- Tap **Choose starting point....** The starting point is set to your current location as default. To change it, tap **My Location** and type a new point in the **Choose starting point...** field or select a point from the list.
  - Tap **Choose destination...** and type your destination or select a destination from the list.
  - Tap  to switch the starting point and the destination.
3. Select the way to get to the destination (by car, by public transit, or by foot).
    - You may tap  or **Options** to configure available settings options.
  4. Tap the result to see the details.



## Music

You can play digital audio files saved on the phone or the microSD Card using your phone's music applications. See [Use the Phone's microSD Card as a Media Device](#) for copying files.











### Music Player

The Music Player app plays audio files including Digital Right Management (DRM) files.

## Access the Music Player App

1. Press  >  > **Music Player**.
2. Tap the category tab to view its contents. Swipe across the screen to display all tabs. Available categories are:
  - **Artists:** Displays your music sorted by artist.
  - **Albums:** Displays your music sorted by album.
  - **Songs:** Displays all your songs in alphabetical order.
  - **Playlists:** Displays your playlists. See [Use Playlists](#).
  - **Genres:** Displays your music sorted by genre.
  - **Composers:** Displays your music sorted by composer.
3. You may do any of the following:
  - Tap an item to display the contents or play the item.
  - Tap , or touch and hold an item, for available options.
  - Tap the Now Playing tab at the bottom of the screen to play the song, if available.

## Play Music

1. On the Music Player app, browse for the item you want to play.
2. Tap the item. The music starts to play on the Playback screen.
  - You may also tap  next to the item, or touch and hold the item, and tap **Play**.
3. The following options are available for the control:
  - Drag the slider to rewind or fast-forward.
  - Tap  to pause. Tap  to resume playing.
  - Tap  to go back to the start of the current item. Tap  to jump to the start of the next item.
  - Tap  to display the Now Playing list.
  - Tap  **Shuffle is off** or  **Shuffle is on** for toggling the shuffle options.
  - Tap  **Repeat is off**,  **Repeating all songs** or  **Repeating current song** for cycling through the repeat options.

- Tap  for additional options. Available menus may vary:
  - **Top Menu** to go back to the top screen of the app.
  - **Add to playlist** to add the item to a playlist.
  - **Delete** to delete the item. The data will be deleted from the phone or the storage card.
  - **Sound effects** to open the Equalizer screen.
  - **Use as phone ringtone** to assign the item as a phone ringtone.
  - **Search** to search the item. Select an app to use for the search.

**Tip:** You may touch and hold on the text information on the Playback screen such as the name of the song, album or the artist for searching the information.

## Use Playlists

Create and manage a playlist to organize your music.

To create a playlist:

1. On the Music Player app, browse for the item you want to add to the playlist.
2. Tap  next to the item, or touch and hold the item, and tap **Add to playlist**.
3. On the Add to playlist window, tap **New**.
4. Type the name of your new playlist and tap **Save**. It is added to the **Playlists** tab.

To add an item to an existing playlist:

1. On the Music Player app, browse for the item you want to add to the playlist.
2. Tap  next to the item, or touch and hold the item, and tap **Add to playlist**.
3. On the Add to playlist window, tap the name of the playlist that you want to add the item to.

To remove an item from a playlist:

1. On the Music Player app, tap the **Playlists** tab.
2. Tap the playlist which contains the item you want to remove from the playlist.
3. Tap  next to the item, or touch and hold the item, and tap **Remove from playlist**.

To rename a playlist:

1. On the Music Player app, tap the **Playlists** tab.
2. Tap  next to the item, or touch and hold the item, you want to rename and tap **Rename**.
3. Type the new name and tap **Save**.

To delete a playlist:

1. On the Music Player app, tap the **Playlists** tab.
2. Tap  next to the item, or touch and hold the item, you want to delete and tap **Delete**.
3. Tap **OK** to confirm.

## Play Music

Access the Play Music app to enjoy your favorite music.

### Access the Play Music App

1. Press  >  > **Play Music**. The Google Play Music screen appears.



**Note:** If you have signed up for Google Music™, the first time you open the Play Music application you will be prompted to select the account with the online music library you want to access. Follow the onscreen instructions to continue.



2. Tap an option to start playing music:
  - **Listen Now:** Your starting point to play music. See [The Listen Now Screen](#).
  - **My Library:** Your music is sorted by **GENRES**, **ARTISTS**, **ALBUMS**, and **SONGS**.
  - **Playlists:** Your playlists are displayed.

**Note:** Tap **SETTINGS**, **HELP**, or **SEND FEEDBACK** for additional options.

### The Listen Now Screen

Learn the basics to use the Play Music application.

- ▶ Tap **Shuffle all** to play the music on your phone in shuffle mode.
- ▶ Tap an album image and then tap a song in the album to play it.
- ▶ Tap  for available options.
- ▶ Tap  to search for music.
- ▶ Tap  on the top left of the screen, or touch and hold the left end of the screen and slide it to the right, to display the screen options. See [Access the Play Music App](#).

The label of the currently played song appears at the bottom of the screen when you play music. Simply tap  or  on the label or tap the label to display a screen with more control menus to manage.

## *Back Up Your Downloaded Music Files*

It is recommended that you back up your downloaded music files to your computer. Although the downloaded files can only be played on your phone and on your account, backing them up to your computer lets you access the files in case your microSD card is lost or damaged, or if you install a new microSD card. See [microSD Card](#).

1. Connect your phone to your computer using a USB cable.
2. Use your computer to navigate to the microSD card's Music folder.
3. Select and copy the music files to a folder on your computer's hard drive.

# Web and Data

---

Your phone's data capabilities let you wirelessly access the Internet or your corporate network through a variety of connections including Wi-Fi, 4G LTE, 3G, GPRS, 1X, and Virtual Private Networks (VPN).

The following topics address your phone's data connections and the built-in Web browser. Additional data-related features can be found in [Accounts and Messaging](#), [Apps and Entertainment](#), and [Tools and Calendar](#).



## Wi-Fi

Wi-Fi provides wireless Internet access over distances of up to 300 feet. To use your phone's Wi-Fi, you need access to a wireless access point or "hotspot."

The availability and range of the Wi-Fi signal depends on a number of factors, including infrastructure and other objects through which the signal passes.

### Turn Wi-Fi On and Connect to a Wireless Network

Use the Wireless & networks setting menu to enable your phone's Wi-Fi radio and connect to an available Wi-Fi network.

1. Press  >  > **Settings**.
2. If the **OFF** icon is displayed next to **Wi-Fi**, tap it to turn Wi-Fi on. The **ON** icon is displayed and the phone will scan for available wireless networks.
3. Tap **Wi-Fi**. The network names and security settings (open network or secured with WEP/WPA/WPA2 PSK/802.1x EAP) of detected Wi-Fi networks are displayed.
4. Tap a Wi-Fi network to connect. If you selected an open network, you will be automatically connected to the network. If you selected a network that is secured with a password, enter the password and then tap **Connect**.

Depending on the network type and its security settings, you may also need to enter more information or choose a security certificate.

When your phone is connected to a wireless network, the Wi-Fi icon  appears in the status bar and tells you the approximate signal strength. (The above icon indicates maximum signal strength.)



If **Network notification** in Advanced Wi-Fi settings is enabled, the open network icon  appears in the status bar whenever the phone detects an available open wireless network within range.

**Note:** The next time your phone connects to a previously accessed secured wireless network, you will not be prompted to enter the password again, unless you reset your phone to its factory default settings or you instruct the phone to forget the network.

**Note:** Wi-Fi networks are self-discoverable, which means no additional steps are required for your phone to connect to a Wi-Fi network. It may be necessary to provide a user name and password for certain closed wireless networks.

## Check the Wireless Network Status



Check the status of your current wireless network, including speed and signal strength, through the Wi-Fi settings menu.

1. Press  >  > **Settings** > **Wi-Fi**.
2. Tap the wireless network that the phone is currently connected to. You will see a message box showing the Wi-Fi network name, status, speed, signal strength, and other details.

**Note:** If you want to remove the phone's wireless network settings, tap **Forget** on this window. You need to enter the settings again if you want to connect to this wireless network.

## Connect to a Different Wi-Fi Network





Use the Wireless & networks settings menu to scan for and connect to a different Wi-Fi network.

1. Press  >  > **Settings** > **Wi-Fi**.
  - Detected Wi-Fi networks are displayed in the Wi-Fi networks section. To manually scan for available Wi-Fi networks, tap  > **Scan**.
2. Tap another Wi-Fi network to connect to it.

**Note:** If the wireless network you want to connect to is not in the list of detected networks, tap . Enter the wireless network settings and tap **Save**.

## The Wi-Fi Settings Menu

The Wi-Fi settings menu lets you turn Wi-Fi on or off, set up and connect to available Wi-Fi networks, and configure advanced Wi-Fi options.

- ▶ Press  >  > **Settings** > **Wi-Fi**.
  - Tap  to set up a Wi-Fi Protected Setup connection by pressing the set up button on the router.
  - Tap  to add a new Wi-Fi network.
  - Tap  for the following menus:



- **Scan** to scan for Wi-Fi networks.
- **WPS Pin Entry** to set up a Wi-Fi Protected Setup connection by entering the PIN on your router.
- **Wi-Fi Direct** to use a peer-to-peer Wi-Fi connection. The Wi-Fi client and the hotspot operation will be disabled while Wi-Fi direct is enabled.
- **Advanced** to configure advanced Wi-Fi settings, which include:
  - **Network notification** to notify you when an open network is available.
  - **Keep Wi-Fi on during sleep** to stay connected to Wi-Fi when the screen goes to sleep to conserve mobile data usage.
  - **Scanning always available** to let Google's location service and other apps scan for networks even when Wi-Fi is off.
  - **Avoid poor connections** to avoid a Wi-Fi network unless it has a good Internet connection.
  - **Wi-Fi frequency band** to specify the frequency band for Wi-Fi.
  - **Install certificates** to install the certificates for communicating via Wi-Fi.
  - **Wi-Fi optimization** to minimize the battery usage when Wi-Fi is on.
  - **MAC address** to display the Media Access Control (MAC) address of your phone when connected to a Wi-Fi network.
  - **IP address** to display the Internet Protocol (IP) address assigned to your phone by the Wi-Fi network you are connected to (unless you used the IP settings to assign it a static IP address).

## Data Services

The following topics will help you learn the basics of using your data services including managing your user name, launching a data connection, and navigating the Web with your phone.

**Important:** Certain data services requests may require additional time to process. While your phone is loading the requested service, the touchscreen may appear unresponsive when in fact they are functioning properly. Allow the phone some time to process your data usage request.

### Launch a Web Connection

Launching a Web connection is as simple as opening the browser on your phone.





► Press  >  > **Browser.**

**Note:** Internet connections can be made either through the data services such as 4G and 4G LTE or via Wi-Fi (configured within the **Settings > Wi-Fi** page).

**Note:** The browser automatically launches when a Web link is tapped from within either an email or text message.

## Data Connection Status and Indicators

Your phone displays the current status of your data connection through indicators at the top of the screen. The following symbols are used:

Icon	Description
	Your phone is connected to the high-speed 4G LTE network.
	Your phone is connected to the 3G network.
	Your phone is connected to the GPRS network.
	Your phone is connected to the 1X network.

When the arrows are animated, your phone is transferring data (for example, when you are opening a Web page); when the arrows are gray, your phone is connected to the network but is not currently transferring data (for example, when you are viewing a Web page that is completely open). In either state, you can receive incoming calls.

If you do not see an indicator, your phone does not have a current data connection. To launch a connection, see [Launch a Web Connection](#).

## Virtual Private Networks (VPN)

From your phone, you can add, set up, and manage virtual private networks (VPNs) that allow you to connect and access resources inside a secured local network, such as your corporate network.



### Prepare Your Phone for VPN Connection

Depending on the type of VPN you are using at work, you may be required to enter your login credentials or install security certificates before you can connect to your company's local network. You can get this information from your network administrator.

Before you can initiate a VPN connection, your phone must first establish a Wi-Fi or data connection. For information about setting up and using these connections on your phone, see [Launch a Web Connection](#) and [Turn Wi-Fi On and Connect to a Wireless Network](#).

## Install Security Certificates

Your network administrator may instruct you to download and install security certificates to connect to the network.

1. Download and install the certificates needed to access your local network into a microSD card. Your network administrator can tell you how to do this.
2. Insert the microSD card into your phone. See [Insert or Remove a microSD Card](#).
3. Press  >  > **Settings** > **Security** > **Install from SD card**, and install the necessary security certificates.

## Add a VPN Connection

Use the Wireless & networks settings menu to add a VPN connection to your phone.

1. Press  >  > **Settings** > **More...** > **VPN** > **Basic VPN**.

**Note:** Tap **Advanced VPN** to access the KeyVPN app.



2. If you are asked to set up a screen lock, tap **OK** and set up a required type of lock. To set up a screen lock, see [Screen Lock](#).
3. Tap  and enter the information for the VPN you want to add.
  - Information may include Name, Type, Server address, PPP encryption (MPPE), and advanced options.
  - Set up all options according to the security details you have obtained from your network administrator.
4. Tap **Save**.

The VPN is then added to the VPNs section of the VPN settings screen.

## Connect to or Disconnect from a VPN

Once you have set up a VPN connection, connecting and disconnecting from the VPN is easy.

### Connect to a VPN

1. Press  >  > **Settings** > **More...** > **VPN** > **Basic VPN**.
2. In the VPNs section, tap the VPN that you want to connect to.
  - Tap  > **Always-on VPN** to select a VPN profile to always remain connected to.
3. When prompted, enter your login credentials and then tap **Connect**. When you are connected, a VPN connected icon appears in the notification area.

4. Open the Web browser to access resources such as intranet sites on your corporate network. For more information about browsing the Web, see [Learn to Navigate the Browser](#).

## Disconnect from a VPN

1. Slide the status bar down to open the Notifications panel.
2. Tap the VPN connection to return to the VPN settings screen and then tap the VPN connection to disconnect.

When your phone has disconnected from the VPN, a VPN disconnected icon briefly appears in the notification area.

## Browser

Your phone's Web browser gives you full access to both mobile and traditional websites on the go using 4GLTE, 3G, GPRS, 1X, or Wi-Fi data connections.

### Launch the Web Browser

Launching the browser is as easy as tapping an icon.

- ▶ Press  >  > **Browser**.

**Tip:** Your phone supports additional Web browser Google Chrome. Press  >  > **Chrome** to launch Chrome.

### Learn to Navigate the Browser

Navigating through menus and websites during a data session is easy once you have learned a few basics.

#### Scrolling

As with other parts of your phone's menu, you'll have to drag up and down to see everything on some websites.

To scroll through a website's page:

- ▶ In a single motion, touch and drag across or up and down a page.

#### Selecting

To select onscreen items or links:

- ▶ Scroll across a page, and then tap an item or onscreen link.

Links, which are displayed as underlined text, allow you to jump to Web pages, select special functions, or even place phone calls.

## Pinching and Zooming

Zooming in and out on a Web page can be done without the need of an onscreen zoom tool. Just use your fingers to pinch in or spread out on the screen.

To zoom in:

1. Place your thumb and index finger on the screen.
2. Expand them outward (spread) to zoom in.

To zoom out:

1. Place your thumb and index finger on the screen.
2. Bring them together (pinch) to zoom out.

## Go Back

To go back one page:

- ▶ Press  on your phone. Repeat this process to keep going back through your Web page history of recently visited pages.

## Go to a Specific Website

1. Tap the search/address field at the top of the browser window and enter a new Web address.
  - As you enter the address, possible matches are displayed within an onscreen list. Tap an entry to launch the desired website.

**Tip:** You can also enter a search term into the field to perform a Web search.



2. Tap **Go** on the keyboard to launch the new page.

## Browser Menu

The browser menu offers additional options to expand your use of the Web on your phone.

### Open the Browser Menu

The browser menu may be opened from any page you are viewing.

1. Press  >  > **Browser**.
2. From any open Web page, tap . You will see the browser menu.

Options available within the browser menu may include:

- **Stop:** Stops loading the current Web page.

- **Refresh:** Reloads the current Web page.
- **Forward:** Returns you to a previously viewed page.
- **Homepage:** Returns you to the home page.
- **Bookmarks:** Allows you to access and manage your bookmarks. See [Manage Bookmarks](#).
- **Save to bookmarks:** Adds the currently viewed page to bookmarks.
- **Share page:** Allows you to share the URL via Gmail, SMS, Email, Bluetooth, etc.
- **Find on page:** Allows you to search in the current page.
- **Request desktop site:** Allows you to assign the browser to display the current page in the desktop view (to closely mimic the display as it would appear on a Desktop computer).
- **Save for offline reading:** Saves the Web page so you can read it later even when offline.
- **Settings:** Allows you to modify your Web settings. For more information, see [Adjust Browser Settings](#).
- **Exit:** Closes the browser.

## Select Text on a Web Page

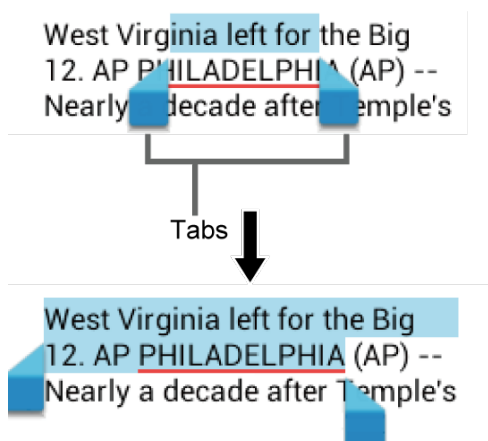

You can highlight text on a Web page and copy it, search for it, or share it.

1. Scroll to the area of the Web page containing the text you want to select.
2. Touch and hold the text you want to copy. Drag the tabs to expand or reduce the range of the selected text. Any selected text will appear highlighted.



**Tip:** Tap  to select all the text on the Web page.

3. Select an option:

-  to copy the selected text.
-  to share the selected text via Bluetooth, Gmail, Messaging, etc.
-  to launch a Web search for the selected text.

## Adjust Browser Settings

You can control many of the settings for your browser through the browser settings menu, including general page settings, privacy and security, accessibility settings, advanced settings such as Javascript and plug-ins, bandwidth management, and labs settings.

1. Press  >  > **Browser**.

2. From any open Web page, tap  > **Settings**. You will see the browser settings menu.

3. You can access the following settings menus:

- **General**
  - **Set homepage:** Sets the home page for the Web browser. See [Set the Browser Home Page](#).
- **Privacy & security**
  - **Clear cache:** Deletes all currently cached data. Tap **OK** to complete the process.
  - **Clear history:** Clears the browser navigation history. Tap **OK** to complete the process.
  - **Show security warnings:** Notifies you if there is a security issue with the current website.
  - **Accept cookies:** Allows sites that require cookies to save and read cookies from your phone.
  - **Clear all cookie data:** Clears all current browser cookie files. Tap **OK** to complete the process.
  - **Remember form data:** Allows the phone to store data from any previously filled-out forms.
  - **Clear form data:** Deletes any stored data from previously filled out forms. Tap **OK** to complete the process.
  - **Enable location:** Allows sites to request access to your current location (using the built-in GPS function).



- **Clear location access:** Clears location access for all websites. Tap **OK** to complete the process.
- **Accessibility**
  - **Text scaling:** Changes the text size to the size you see on its preview screen.
  - **Minimum font size:** Sets the minimum font size on the Web as you see on its preview screen.
- **Advanced**
  - **Set search engine:** Sets the search engine.
  - **Open in background:** New pages are launched in a separate page and displayed behind the current one.
  - **Enable JavaScript:** Enables JavaScript for the current Web page. Without this feature, some pages may not display properly.
  - **Allow multiple tabs per app:** Allows you to use multiple navigation tabs per application.
  - **Enable plug-ins:** Allows you to determine the way your phone handles program enhancements. Select from **Always on**, **On demand**, or **Off**.
  - **Website settings:** Allows you to manage advanced settings for individual websites.
  - **Open pages in overview:** Provides an overview of the recently opened pages.
  - **Block pop-ups:** Prevents pop-up advertisements or windows from appearing onscreen. Clear the check mark to disable this function.
  - **Text encoding:** Adjusts the current text encoding. Tap an option to select.
  - **Reset to default:** Resets the browser settings to default. Tap **OK** to complete the process.
- **Bandwidth management**
  - **Search result preloading:** Allows browser to preload high confidence search results in the background. Select from **Never**, **Only on Wi-Fi**, or **Always**.
  - **Web page preloading:** Allows browser to preload linked Web pages in the background. Select from **Never**, **Only on Wi-Fi**, or **Always**.
  - **Load images:** Displays images on Web pages.
- **Labs**



- **Quick controls:** Opens the Quick controls and hides applications and URL bars.
- **Fullscreen:** Enables full screen mode and hides the status bar.

## Set the Browser Home Page



Customize your Web experience by setting your browser's home page.

1. Press  >  > **Browser**.
2. From any open Web page, tap  > **Settings** > **General** > **Set homepage**.
3. Select an option to set your browser's home page:
  - **Current page** to set the current page as the home page.
  - **Blank page** to set a blank page as the home page. This helps new Browser windows to open more quickly.
  - **Default page** to set a factory default URL as home page.
  - **Most visited sites** to select a home page from a list of recently visited sites.
  - **Other** to enter a specific website address for your home page. Enter the address and tap **OK**.



## Manage Bookmarks

Make browsing easier by setting up and using custom bookmarks.

### View Bookmarks





1. Press  >  > **Browser**.
2. From any open Web page, tap  > **Bookmarks**. You will see three tabs:
  - **BOOKMARKS:** Displays a list of your current Web bookmarks.
  - **HISTORY:** Displays a record of your browsing history. These records are organized into folders such as: **Today**, **Yesterday**, **Last 7 days**, and **Most visited**.
  - **SAVED PAGES:** Displays a list of websites you saved for offline reading. Tap an entry to launch the selected page.

### Create Bookmarks



1. Press  >  > **Browser**.
2. Open the Web page you want to bookmark and tap  > **Save to bookmarks**.
3. Enter a descriptive name for the new bookmark.

4. Select an account you want to add the bookmark to.
5. Select where to save the bookmark and tap **OK**.



### Create Bookmarks from History

1. Press  >  > **Browser** >  > **Bookmarks**.
2. Tap the **HISTORY** tab.
3. Tap  next to the page you want to bookmark.
4. Edit the necessary information and tap **OK**. The star now turns into .

### Set a Bookmarked or Browsed Page as Homepage

1. Press  >  > **Browser** >  > **Bookmarks**.
2. Touch and hold an entry under the **BOOKMARKS** or **HISTORY** tab to display an onscreen popup menu.
3. Tap **Set as homepage** to assign the entry as your new homepage.

### Add a Bookmark to Your Home Screen



1. Press  >  > **Browser** >  > **Bookmarks**.
2. Touch and hold an entry under the **BOOKMARKS** tab to display an onscreen popup menu.
3. Tap **Add shortcut to home** to add the selected entry to your Home screen.

## Portable Wi-Fi Hotspot

Portable Wi-Fi hotspot allows you to turn your phone into a Wi-Fi hotspot. The feature works best when used in conjunction with 4G LTE data services.

**Note:** Use of this service requires a subscription to the applicable modem plan. Follow the onscreen instructions to subscribe to the service.

### Set Up Portable Wi-Fi Hotspot

1. Press  >  > **Settings** > **More...** > **Tethering & portable hotspot**.
2. Tap **Portable Wi-Fi hotspot** to place a check mark in the adjacent field to activate the service.
3. Read the message displayed and tap **Accept**.

- Using both 4G LTE service and hotspot drains your phone's battery at a much faster rate than when using any other feature combination.

When portable Wi-Fi hotspot is active and is ready to share its connection, the hotspot icon  appears on the status bar.



**Note:** The best way to keep using the phone as a hotspot is to have it connected to a power supply.

**Important:** Write down the passkey (password) for this communication (shown onscreen).

### Connect to Portable Wi-Fi Hotspot

1. Enable Wi-Fi (wireless) functionality on your target device (laptop, media device, etc.).
2. Scan for Wi-Fi networks from the device and select your phone hotspot from the network list.
3. Select this device and follow your onscreen instructions to enter the passkey (provided on the portable Wi-Fi hotspot page).
4. Launch your Web browser to confirm that you have an Internet connection.

### Portable Wi-Fi Hotspot Settings



1. Press  >  > **Settings** > **More...** > **Tethering & portable hotspot** > **Portable Wi-Fi hotspot settings**.
2. Tap the following options to configure the necessary settings:
  - **Configure Portable Wi-Fi hotspot** to modify the following options and tap **Save**.
    - **Your Wi-Fi network SSID:** Set your network name.
    - **Security:** Select a security level.
    - **Password:** Set a password.
    - **Show password:** Select the checkbox to display the password.
    - **Broadcast network name (SSID):** Select the checkbox to make your phone visible to other devices.
  - **Portable Wi-Fi hotspot turn off timer:** Select when to deactivate the Hotspot feature.

## Tethering

You can share your phone's Internet connection via a USB cable or Bluetooth.

## USB Tethering



You can tether your phone to your computer with a USB cable and share your phone's Internet connection with your computer.

1. Press  >  > **Settings** > **More...** > **Tethering & portable hotspot**.
2. Select the **USB tethering** check box to turn on the tethered mode.

**Note:** Use of this service requires a subscription to the applicable modem plan. Follow the onscreen instructions to subscribe to the service.

## Bluetooth Tethering

You can share your phone's Internet connection with Bluetooth devices via Bluetooth.

1. Press  >  > **Settings** > **More...** > **Tethering & portable hotspot**.
2. Select the **Bluetooth tethering** check box.
3. Pair your phone with a Bluetooth device. If they are already paired, establish their connection. See [Connect a Bluetooth Headset or Car Kit](#) or [Reconnect a Headset or Car Kit](#) for details.

# Camera and Camcorder

You can use the camera or camcorder to take and share pictures and videos. Your phone comes with an 8.0 megapixel back camera and 2.0 megapixel front camera with an autofocus feature that lets you take sharp pictures and videos.

## Use the Camera App

The following topics teach you how to take pictures and record videos.

### Open or Close the Camera App

The first step in taking a picture or recording a video is to open the camera app.

#### Open the Camera App

- ▶ Press  >  > **Camera**.

#### Close the Camera App

- ▶ On the camera screen, press  or .

### Viewfinder Screen

The viewfinder screen lets you view your subject and provides controls and options for taking pictures or recording videos.





- **Battery Icon:** Displays how full the battery is.
- **Storage Area:** Displays where the pictures and videos will be saved; microSD or phone.
- **Available Shots/Time:** Displays remaining shots/time with the current settings.

- **Zoom Slider:** Adjusts your zoom level.
- **Thumbnail:** Displays the thumbnail of the latest image. Tap to view and manage.
- **Shutter Button:** Takes a picture.
- **Record Button:** Records a video.
- **Switch Button:** Switches between the back camera and the front camera.
- **Settings Button:** Opens the camera and camcorder settings menu. For more information, see [Camera and Camcorder Settings](#).

## Take a Picture or Record a Video

You can record high quality images with your phone's camera and camcorder.

1. Press  >  > **Camera**.
2. Do the following to change the settings:
  - Tap **Switch to** to switch between the front camera and the back camera.
  - Tap **Settings** to change the camera and camcorder settings as desired. See [Camera and Camcorder Settings](#).
  - Tap or drag the zoom slider, or slide the screen parallel to the slider, to zoom in or out on your subject.
3. Frame your subject on the screen.

**Tip:** Hold the phone vertically when taking portrait shots or hold the phone horizontally when taking landscape shots.

4. Tap  to take a picture.

– or –

Tap  to record a video. Tap  to stop recording.

5. Choose what you want to do with the image you've just taken or recorded. See [Review Screen](#).

## Review Screen

After taking a picture or video, tap the thumbnail image to see the item in the review screen. From there, you can instantly share your photos or videos (see [Share Pictures and Videos](#)) or tap the Gallery icon to edit your photos or replay your videos (see [View Pictures and Videos Using Gallery](#)).

To review the image:

1. Tap the thumbnail image on the screen.
2. If options are displayed, select the desired application to view the image.
3. Tap **Always** to use the selected application all the time, or tap **Just once** to select the application for this once.

To display options for the displayed image:

- ▶ Tap the image to display available options. For example, when you view a picture selecting the Gallery app, you may see the following options:



- **Gallery:** The app you have selected to view the image is displayed. Tap to access the app. See [View Pictures and Videos Using Gallery](#).
- **Share:** Displays applications to share your image.
- **Menu:** Displays menus for the image. Available menus may vary:
  - **Delete:** Deletes the currently displayed image. Tap **OK** to confirm the deletion.
  - **Slideshow:** Starts the slideshow of the pictures stored in the Gallery application.
  - **Rotate left/Rotate right:** Rotates the picture.
  - **Crop:** Crops the picture. See [Crop a Picture](#).
  - **Set picture as:** Sets the picture as the contact photo or wallpaper.
  - **Details:** Shows the details of the picture.
  - **Print:** Displays the printing menu.

## Camera and Camcorder Settings

You can adjust the settings of your camera and camcorder by tapping **Settings** on the viewfinder screen. Some options are available for the back camera or camcorder only.

- **Mode:** Select from **Normal**, **Color effect**, **Continuous shooting**, **Panorama**, **Smile shutter**, **HDR**, **DSLR-style defocus**, or **Quick shot**.
  - **Normal:** Takes a normal picture.
  - **Color effect:** Takes a picture with various types of color effects, such as **Poster**, **Pencil**, **Sepia**, **Black & White**, and more.
  - **Continuous shooting:** Takes up to 30 pictures continuously when pressing the shutter button.
  - **Panorama:** Takes a panorama picture as you pan the phone sideways.
  - **Smile shutter:** Detects a smile on a face and automatically takes a picture without having to tap the shutter button.
  - **HDR:** Takes three pictures at different exposure levels and combines them into one picture. It compensates the loss of detail at each exposure level and helps produce a clear and detailed picture. The shutter sounds only once while taking the three pictures.
  - **DSLR-style defocus:** Takes a picture with an effect of shallower depth of field by blurring the background.
  - **Quick shot:** Takes a picture the moment you tap the shutter button, minimizing the shutter lag.
- **Camera scene:** Select from **Auto**, **Portrait**, **Landscape**, **Night portrait**, **Night landscape**, or **Action**.
- **White balance:** Select from **Auto**, **Daylight**, **Cloudy**, **Incandescent**, or **Fluorescent**.
- **Flash:** Allows you to choose a flash setting for pictures or turn the light on or off while recording a video. Select from **Auto**, **On**, or **Off**. For videos, selecting **Auto** is the same as selecting **Off**.
- **More:**
  - **Picture size:** Select from **8.0MP(3264x2448)**, **w6.0MP(3264x1836)**, **5.0MP(2560x1920)**, **3.2MP(2048x1536)**, **2.0MP(1600x1200)**, **w1.0MP(1280x720)**, **0.8MP(1024x768)**, or **VGA(640x480)**.
  - **Video size:** Select from **HD(1080p)**, **HD(720p)**, **DVD(480p)**, **VGA**, **QVGA(MMS)**, or **QCIF(MMS)**.



- **Focus settings:** Select from **Continuous AF**, **Face detection**, **Macro**, or **Infinity**.
- **Auto exposure:** Select from **Center weighted**, **Frame average**, or **Spot metering**.
- **Brightness:** Select **Auto** or **Manual**. Use the slider to set brightness when selecting **Manual**.
- **Contrast:** Select **Auto** or **Manual**. Use the slider to set contrast when selecting **Manual**.
- **Image stabilization:** Select **On** or **Off**.
- **Self-timer:** Select from **Off**, **3 seconds**, **5 seconds**, or **10 seconds**.
- **Select ISO:** Select from **Auto**, **100**, **200**, **400**, or **800**.
- **Auto review:** Select from **Off**, **2 seconds**, or **No limit**.
- **Blink detection:** Select **On** or **Off**.
- **Picture quality:** Select from **Super fine**, **Fine**, or **Normal**.
- **Volume key:** Select a function to assign to the volume key choosing from **Take a picture**, **Record a video**, or **Zoom**.
- **Shutter sound:** Select **On** or **Off**.
- **Store location:** Stores the location information of the image. Select **On** or **Off**.
- **Auxiliary line:** Select **Off** or **Grid**.
- **Time lapse recording:** Select from **Off**, **1s**, **1.5s**, **2s**, **2.5s**, **3s**, **5s**, or **10s**.
- **Audio recording:** Select **Unmute** or **Mute**.
- **Storage:** Select where to store your pictures and videos from **Phone** or **SD card**.
- **Default settings:** Restores all the camera and camcorder settings to default. Tap **OK** to confirm.

**Note:** Some settings may not be available depending on other settings. For example, if you select an option other than **Auto** for **Camera scene**, you cannot select **White balance**, **Flash**, **Focus settings**, **Auto exposure**, **Brightness**, and **Select ISO**.

## *View Pictures and Videos Using Gallery*

Using the Gallery application, you can view pictures and watch videos that you've taken with your phone's camera, downloaded, or copied onto your microSD card or phone's internal memory.

For pictures that are on your microSD card or phone's internal memory, you can do basic editing such as rotating and cropping. You can also easily assign a picture as your contact picture or wallpaper and share pictures with your friends.

## Open or Close Gallery

The Gallery app opens in the Albums view where your pictures and videos are organized by albums for easy viewing.

### Open the Gallery App

► Press  >  > **Gallery**.

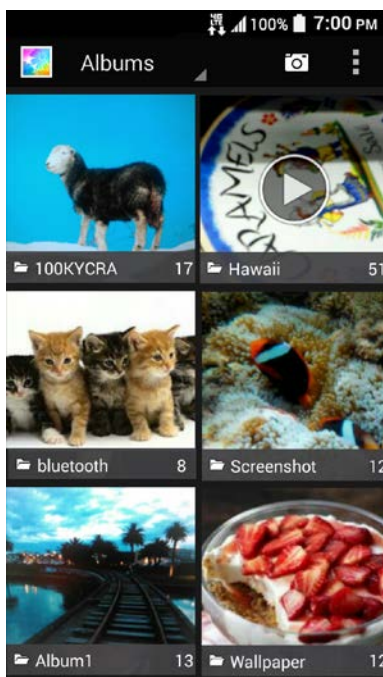

Photos or videos you took with the internal camera are stored in **100KYCRA** album. The number before “**KYCRA**” may vary.

Folders in your storage card or phone memory that contain pictures and videos will also be treated as albums. The actual folder names will be used as the album names. If you have downloaded any pictures or videos, these will be placed in the **Download** album.

When viewing pictures in Gallery, scroll left or right to view more albums. Simply tap an album to view the pictures or videos in that album.

**Note:** Depending on the number of pictures stored, it may take some time for Gallery to load all your albums on the screen.

### Close the Gallery App

► While in the Gallery screen, press .



## View Pictures and Videos

After selecting an album, you can browse through the pictures and videos of that album in grid view. Tap a picture or video to view.

1. Press  >  > **Gallery** and tap an album (such as 100KYCRA).

**Note:** Tap  and select an option to view images in slideshow, select images, or group images.

**Note:** Tap **Grid view** > **Filmstrip view** to change the view.

2. Tap an image to view a picture or video.
  - For playing the video, tap . Tapping the screen while playing the video will display the control options. Tap  to pause the video or drag the dot on the timeline to rewind or forward the video.

## Zoom In or Out on a Picture

There are two ways you can zoom in or out on a picture.

- ▶ Tap the screen twice quickly to zoom in and then tap the screen twice quickly again to zoom out.

– or –



Pinch the screen using your thumb and forefinger to zoom out or spread the screen to zoom in.

## Work with Pictures

You can manage your pictures.

### Picture Options Menu

Various options are available while viewing a picture.

- ▶ With a picture displayed, tap the following icons:
  -  to display the sharing options.
  -  to display the following options:
    - **Delete:** Deletes the displayed image. Tap **OK** to confirm the deletion.
    - **Slideshow:** Starts the slideshow of the stored pictures.
    - **Edit:** Provides some editing options. See [Edit a Picture](#).
    - **Rotate left/Rotate right:** Rotates the picture.



- **Crop:** Crops the picture. See [Crop a Picture](#).
- **Set picture as:** Sets the picture as the contact photo or wallpaper.
- **Details:** Shows the details of the picture.
- **Print:** Provides the printing options.
-  to access the edit screen. See [Edit a Picture](#).

## Edit a Picture

Your phone has a built in editing tool and you can alter your pictures easily.

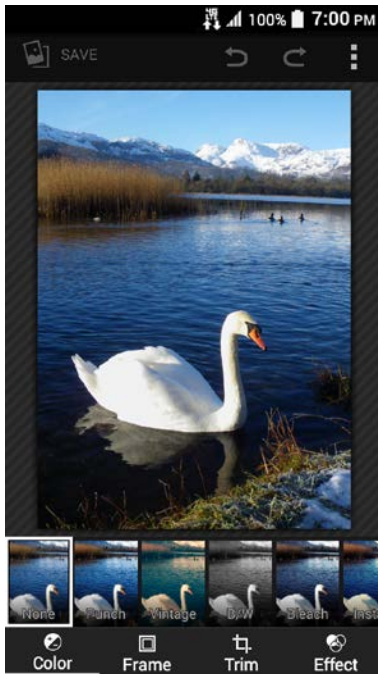
1. Tap a picture and tap , or  > **Edit**. The following screen is displayed.



2. Tap a thumbnail for the labeled effect. You may scroll the thumbnails right or left to view more options. You can also tap the following option:
  - **Color:** Displays options to apply color effects.
  - **Frame:** Displays options to add a frame.
  - **Trim:** Displays options to crop, straighten, rotate, etc. the picture.
  - **Effect:** Displays options to adjust the exposure, contrast, sharpness, etc.
  -  : Undoes an action.
  -  : Redoes an action.

- : Displays options for resetting the image to the original state, displaying the applied effects to the image, exporting the image, etc.

3. When finished, tap **SAVE**.

### Rotate and Save a Picture

1. Tap the picture you want to rotate.
2. Tap  > **Rotate left** or **Rotate right**.

### Crop a Picture

1. Tap the picture you want to crop.
2. Tap  > **Crop**. A crop box appears on the picture.
3. To adjust the crop box size, touch and hold the edge of the box and drag your finger inward or outward to resize the crop box.
4. To move the crop box to the part of the picture that you want to crop, drag the crop box to the desired position.
5. Tap **SAVE** to apply the changes to the picture.

The cropped picture is saved in the album as a copy. The original picture remains unedited.

## Share Pictures and Videos

The Gallery application lets you send pictures and videos using email or multimedia messages. You can share pictures on your social networks and share videos on YouTube. You can also send them to another phone or your computer using Bluetooth. You can see some examples of how to share your pictures and videos below.

### Send Pictures or Videos by Email/Gmail

You can send several pictures, videos, or both in an email or Gmail message. They are added as file attachments to your email.

1. Touch and hold the picture or video to place a check mark on it. Tap multiple pictures and videos to select them.
2. Tap  > **Email** or **Gmail**.
3. Compose your message and then tap Send button.

**Note:** If you have multiple accounts, the default account will be used.

For more information about sending email and Gmail, see [Send an Email Message](#) or [Send a Gmail Message](#).

## *Send Pictures or Videos by Messaging*

You can send pictures and videos using the Messaging app. Although you can send several pictures or videos, it may be better to just send one at a time, especially if the files are large in size.

1. Touch and hold the picture or video to place a check mark on it. Tap multiple pictures and videos to select them.
2. Tap  > **Messaging**.
3. Compose your message and then tap **Send**.

For more information about multimedia messages, see [Text and Multimedia Messaging](#).

## *Send Pictures or Videos Using Bluetooth*

You can select several pictures, videos, or both and send them to another phone or your computer using Bluetooth.

1. Touch and hold the picture or video to place a check mark on it. Tap multiple pictures and videos to select them.
2. Tap  > **Bluetooth**.
3. You'll be asked to turn on Bluetooth on your phone and connect to the receiving Bluetooth device so the files can be sent. For more information, see [Bluetooth](#).

## *Share Pictures and Videos on Google+*

You need to be signed in to a Google Account to share pictures and videos on Google+.

1. Touch and hold the picture or video to place a check mark on it. Tap multiple pictures and videos to select them.
2. Tap  > **Google+**.
3. Follow the instructions on the screen.

## *Share Videos on YouTube*

You can share your videos by uploading them to YouTube™. Before you do this, you must create a YouTube account and sign in to that account on your phone.

1. Touch and hold the video to place a check mark on it. Tap multiple videos to select them.
2. Tap  > **YouTube**.
3. Enter the prompted information such as title, description, and tags and select a privacy option.

4. Tap .

# Tools and Calendar

---

Learn how to use many of your phone's productivity-enhancing features.



## Calendar

Use Calendar to create and manage events, meetings, and appointments. Your Calendar helps organize your time and reminds you of important events. Depending on your synchronization settings, your phone's Calendar stays in sync with your Calendar on the Web, or the corporate calendar.

### Add an Event to the Calendar

Add events to your calendar directly from the Calendar application.

#### Add an Event

1. Press  >  > **Calendar**.
2. On any Calendar view, tap  > **Event**.
3. If you have multiple calendars, select a calendar to add the event to.

**Note:** You can create multiple Google Calendars only in Google Calendar on the Web. After creating them in Google Calendar on the Web, you'll be able to see them in the Calendar application on your phone. For more information about creating and managing multiple Google Calendars, visit the Google website: [calendar.google.com](http://calendar.google.com).

**Note:** If you have synchronized your phone with an Exchange ActiveSync account or Outlook on your computer, you can also select these calendars.



4. Enter the event name.
5. Enter the event location.
6. Specify the date and time of the event:
  - If there is a time frame for the event, tap the **FROM** and **TO** dates and times to set them.
  - If the event is a special occasion such as a birthday or an all-day event, set the **FROM** and **TO** dates, and then select the **ALL DAY** check box.
  - To change the time zone, tap the time zone field and select an option from the displayed list or type a country name.



7. Enter email addresses to invite guests to your event and add the event descriptions. See [Invite Guests to Your Calendar Event](#).
8. If the event occurs on a regular basis, tap the **REPETITION** field and set the frequency.
9. Set the event reminder time and select how you are notified.
  - If you do not want any reminder, tap  next to the **REMINDERS** field.
  - Tap **Add reminder** to add another reminder.
10. Select your status to be displayed on your calendar.
11. Set the privacy status of this event.
12. Tap **Done**.

## Add a Task

**Note:** The task feature is available for Exchange ActiveSync accounts only.

1. Press  >  > **Calendar**.
2. On any Calendar view, tap  > **Task**.
3. If you have multiple calendars, select a calendar to add the task to.
4. Enter the title of the task.
5. Enter the description.
6. Set the due date of the task.
  - Select the **No due date** check box if the task has no due date.
7. If the task occurs on a regular basis, tap the **REPETITION** field and set the frequency.
8. Set the date and time to remind the task.
  - Select the **No reminder** check box if you do not want any reminder for the task.
9. Set the priority of the task.
10. Tap **Done**.

## *Invite Guests to Your Calendar Event*

If you want to invite guests to your event, you need to create and add the event in your Google Calendar.

An email invitation will be sent to your guests using your account.

1. Open Calendar and create a new event. Tap the Calendar field and then select your account. See [Add an Event to the Calendar](#).
2. Add details about the event such as date and time, location, and more.
3. In the **GUESTS** field, enter the email addresses of everyone you want to invite to the event. Separate multiple addresses with commas.

**Tip:** You can enter a name or email address saved in Contacts to call up the email address or tap  to access your Contacts.

**Tip:** When inviting a guest to the event created by Exchange accounts, you can display the schedule of the guest by tapping **Check the schedule of guests** below the **GUESTS** field.

4. Add the description of the event to be displayed on the email to your guests.
5. Tap **Done** to add the event to your Google Calendar.

If the people to whom you send invitations use Google Calendar, they'll receive an invitation in Calendar and by email.

## Calendar Event Alerts

When your phone is turned on and you have an event alarm scheduled, your phone alerts you and displays the event summary. There are several ways your phone alerts you to scheduled events:

- By playing the assigned ringtone or vibration type.
- By showing  on the status bar.
- By showing the Pop-up notification screen.

## Event Reminders

If you have set at least one reminder for an event, the upcoming event icon  will appear in the notifications area of the status bar to remind you of the upcoming event.

To view, dismiss, or snooze the reminder:

1. Slide the status bar down to open the Notifications panel.

**Note:** If you have other pending event reminders, these events will also appear on the screen.

2. Tap the event name for the following options. When multiple events are displayed, tap the check box next to the event name to select the event:
  - Tap **Set snooze duration** to set the snooze interval.

- Tap **Snooze** to postpone the event reminder for the set duration.
- Tap **Dismiss** to dismiss the reminder.
- Press  to keep the reminder pending on the Notifications panel.
- Tap the event name to access the edit screen of the event. See [Edit Calendar Events](#).

To set reminder settings:

- ▶ On any Calendar view, tap  > **Settings** > **General settings** and set the items under **NOTIFICATIONS & REMINDERS**.

## View Calendar Events





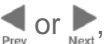
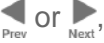



You can display the Calendar in daily, weekly, monthly, agenda or task view. To change the Calendar view, tap the date displayed at the upper left corner, and tap **Day**, **Week**, **Month**, **Agenda**, or **Task**.

The color of the events indicates the type of calendar that includes the event. To find out what each color represents, tap  > **Calendars to display**.

- **Day:** Day view displays a list of the events of one day.
  - Touch and hold on a time slot to create a new event at that time.
  - Tap an event to view its details.
  - Tap , or slide right or left across the screen to view previous day or next day.
- **Week:** Week view displays a chart of the events of one week.
  - Touch and hold on a time slot to create a new event at that time.
  - Tap an event to view its details.
  - Tap , or slide right or left across the screen, to view earlier or later weeks.
- **Month:** Month view displays markers on days that have events.
  - Tap the today icon on the top right to highlight the current day.
  - Tap a day to view the events of that day.
  - Tap , or slide up or down the screen, to view earlier or later months.
- **Agenda:** Agenda view shows a list of all your events in chronological order.
- **Task:** Task view shows a list of all your tasks in chronological order.



## Edit Calendar Events

Edit your calendar events to keep your calendar up to date.

1. Press  >  > **Calendar**.
2. Open the calendar event details:
  - In **Agenda**, **Day**, and **Week** views, tap the calendar event you want to edit.
  - In **Month** view, tap the date where the calendar event occurs and then tap the calendar event.
3. The following options are available. If the event is repeating, a pop up appears asking which event(s) you want to edit or delete:
  - Tap  to assign a color to the event.
  - Tap  to share the event.
  - Tap  to edit the event.
  - Tap  > **OK** to delete the event.
  - **REMINDERS:**
    - Tap the left  to select when you want to receive the reminder before the event occurs.
    - Tap the right  to select how you are notified.
    - Tap  to delete the reminder next to it.
    - Tap **Add reminder** to add another reminder to the event.

## Show or Hide Calendars





If you have more than two calendars available, you can choose to show or hide a calendar from your current view.

1. Press  >  > **Calendar**.
2. In any Calendar view, tap  > **Calendars to display** and then select or clear a calendar to show or hide it.

## Synchronize Calendars with Your Phone

You can choose which Google Calendars to keep synchronized on your phone or which ones to stop synchronizing.

## Synchronize a Google Calendar

1. Press  >  > **Settings** > **Google**.
2. Tap the account you want to sync with.
3. Select the **Calendar** check box.
4. Press  >  > **Calendar**.
5. Tap  > **Calendars to display** > **Calendars to sync**.
6. Select the check box next to the Google Calendar you wish to synchronize.
7. Tap **OK**.

## Synchronize a Corporate Calendar



If you have set up a corporate account on your phone, you can also synchronize corporate calendar events on your phone. Calendar events on your corporate account will also show in Calendar if you chose to synchronize with the Exchange ActiveSync Server.

## Clock

The Clock application functions as a desk clock that shows the date and time. You can also use it to turn your phone into an alarm clock, a countdown timer, or a stopwatch.

### Desk Clock



Your phone works as a desk clock.

1. Press  >  > **Clock**.
2. Tap the **Clock** tab to display the Clock screen, if necessary.

You will see the current date and time on the screen. You will also see an alarm information if you set an alarm in the Alarms screen.

### Night Mode

The current date and time will be displayed on a dimmed screen.

1. Press  >  > **Clock**.
2. Tap the **Clock** tab to display the Clock screen, if necessary.
3. Touch and hold the screen.



– or –

Tap **Menu > Night mode**.



**Tip:** Tap the screen to cancel night mode.

## World Clock

You can add times from around the globe on the Clock screen.

1. Press  >  > **Clock**.
2. Tap the **Clock** tab to display the Clock screen, if necessary.
3. Tap **World clock** and select the check box next to the city you want to display on the Clock screen.
  - The selected cities will be displayed at the top of the city list. Tap  next to the city if you want to remove it from the Clock screen.

## Clock Settings

1. Press  >  > **Clock > Menu**.
2. Tap **Settings** for the following options:
  - **Style:** Select the style of the clock to display. Choose from: **Analog** or **Digital**.
  - **Automatic home clock:** Check to add a clock with your home time to the screen while traveling in a different time zone.
  - **Home time zone:** Select the time zone for your home time.
  - **Silence after:** Select the duration of the alarm to sound.
  - **Snooze length:** Set the interval between snoozes.
  - **Alarm volume:** Set the volume of the alarm.
  - **Volume button behavior:** Select the behavior of the volume key when pressed while the alarm sounds. Choose from: **Silent**, **Snooze**, **Dismiss**, or **Do nothing**.

**Tip:** Tap **Menu > Date & time** to access the Date & time settings menus. See [Date & Time Settings](#).

## Alarm

You can use your phone as an alarm clock. Simply tap the **ON** or **OFF** icon next to an alarm to turn it on or off.

## Set an Alarm

1. Press  >  > **Clock**.
2. Tap the **Alarms** tab to display the Alarms screen, if necessary.

**Note:** When you first open the alarms, two alarms are set up by default and ready for you to customize. These alarms are turned off by default.



3. Tap an existing alarm time to change the settings.

– or –

Tap **Add new** to add a new alarm.



4. Set the time to set off the alarm and tap **Done**. You will see the **ON** icon displayed next to the time you have set.
5. Tap **Add label** to add a description to the alarm.
6. To set the alarm on a regular basis, select the **REPEAT** check box and select the day(s) of the week to repeat the alarm.
7. Tap  to select a ringtone that will play as an alarm.
8. Select the **VIBRATE** check box to add a vibration feature to the alarm.

## Delete an Alarm

1. Press  >  > **Clock**.
2. Tap the **Alarms** tab to display the Alarms screen, if necessary.
3. Tap **Delete** on the alarm you want to delete.

## Timer



You can use your phone as a countdown timer.

1. Press  >  > **Clock**.
2. Tap the **Timer** tab to display the Timer screen, if necessary.
3. Set the countdown time and tap **START** to start the countdown.
4. The following options are available:
  - **Add label** to add a description to the timer.
  - **STOP** to stop the countdown.

- **START** to resume the countdown.
- **+1 minute** to add an extra minute to the remaining time.
- **Reset** to return to the start of the countdown.
- **Delete** to delete the timer.
- **Add new** to add a new timer.



## Stopwatch

You can use your phone as a stopwatch.

1. Press  >  > **Clock**.
2. Tap the **Stopwatch** tab to display the Stopwatch screen, if necessary.
3. Tap **START** to start the stopwatch.
4. The following options are available:
  - **Lap** to record the lap time.
  - **STOP** to stop timing.
  - **START** to resume timing.
  - **Share** to share the recorded time via Messages+, Bluetooth, etc.
  - **Reset** to reset the stopwatch.

## Calculator

Your phone has a convenient calculator that lets you perform basic mathematical equations.







1. Press  >  > **Calculator**.
2. Enter numbers by tapping the onscreen keys.
3. Tap **DELETE** to clear a number. Touch and hold to clear an entire number.
  - To access more advanced features, flick the screen left or tap  > **Advanced panel**.

## Sound Recorder









The Sound Recorder app lets you record sound and save it as an audio file on your phone or the inserted microSD card.











## Record Sound

1. Press  >  > **Sound Recorder**.
2. Tap  to select where to save the recorded data. Select **Phone** or **SD card**.
3. Tap  to start recording.
  - Tap  to pause recording. Tap  to resume recording.
4. Tap  to stop recording.

## Play Audio Data

1. On the screen where you finished recording, tap .  
– or –  
Press  >  > **Sound Recorder** >  and then tap a file.
2. The following options are available:
  - Drag the bar to rewind or fast-forward the data.
  - Tap  to rewind the data by 5 seconds. To change the value, tap  > **Rewind settings** and select from **5 seconds**, **10 seconds** or **15 seconds**.
  - Tap  to display the list of the stored files. See [Stored Sound List Options](#).
  - Tap  to share the file via **Bluetooth**, **Gmail**, **Messaging**, etc.
  - Tap  > **Delete** > **OK** to delete the file.

## Stored Sound List Options

1. Press  >  > **Sound Recorder**.
2. Tap  to display the list of the stored files.
3. The following options are available:
  - Tap  to delete a file or files. Tap a file or files to select the file(s) you want to delete and tap  > **OK**. To select all files on the list, tap  next to  > **Select all**.
  - Tap  next to each file:
    - **Share** to share the file via **Bluetooth**, **Gmail**, **Messaging**, etc.

- **Delete** to delete the file.
- **Edit file name** to rename the file.
- **Details** to display the information about the audio file.

## Voice Services

Your phone's voice services let you place calls using your voice, convert text into speech, and more.

### Automatic Speech Recognition (ASR)

You can use your phone's built-in automatic speech recognition (ASR) software (Voice Dialer) to dial a phone number in your contacts or to launch phone functions. All you have to do is talk into the phone and ASR will recognize your voice and complete tasks by itself.

#### Activate the Voice Dialer

- ▶ Press  >  > **Voice Dialer**.

The phone prompts you to say a command from the list displayed on the screen. To complete your task, simply follow the onscreen prompts or tap an onscreen option.

If the application does not recognize the number, name, or application name, it will find the most likely matches and display a list. Tap a selection or tap **Cancel** to exit the Voice Dialer.

**Tip:** Use ASR in a quiet environment so it can accurately recognize your commands.

#### Make a Voice Call with the Voice Dialer

- ▶ When prompted to speak, say "**Call** [contact]" or "**Dial** [number]."
- For example, say "**Call John Smith on mobile**," to call John Smith's mobile phone. Your phone dials the number stored for the contact "John Smith" with the label "Mobile."

#### Open an Application with the Voice Dialer

- ▶ When prompted to speak, say "**Open** [application name]."
- For example, say "**Open Calendar**," to open the Calendar. The application screen is displayed.

#### Open a Settings Menu with the Voice Dialer

- ▶ When prompted to speak, say "**Open** [settings menu name]."
- For example, say "**Open sound settings**." The Sound settings menu screen is displayed.

## Text-to-Speech

Your phone can convert text into speech in certain downloaded applications. You may select the language you hear or adjust its speed.

1. Press  >  > **Settings** > **Language & input**.

– or –

- Press  >  > **Settings** > **Accessibility**.

2. Tap **Text-to-speech output**. The **Default language status** section shows if the selected default system language is supported by the Text-to-speech system or not.
3. Select your preferred engine. Tap  next to the selected engine to configure the settings.
4. Tap **Speech rate** and select a speed.
5. Tap **Listen to an example** to play a short demonstration of the set speech synthesis.

## Voice Search

Voice Search allows you to find information on the web as well as items and information on your phone by speaking your search terms. See [Voice Search Settings](#) for the settings menus.

1. Tap  on the Google search bar.

– or –

- Press  >  > **Voice Search**.

2. Speak clearly into the phone's microphone when you see **Speak now** on the screen. If an error occurs, try again.
3. Tap a matching item from the onscreen list.



## Eco Mode

Eco Mode allows you to conserve battery life while using your phone.

1. Press  >  > **Eco Mode**.

2. Tap an option to enable or disable the Eco Mode:

- **On:** Enables the Eco Mode. The Eco Mode On icon  appears on the status bar when selected.

- **Auto On:** Enables the Eco Mode when the remaining battery level falls below the set level. Scroll and set the percentage. The Eco Standby icon  appears on the status bar when selected.
  - **Off:** Disables the Eco Mode. The Eco Mode Off icon  briefly appears on the status bar when selected.
3. Configure **Eco settings**. Tap the following items to place or clear a check mark in the adjacent checkbox:
- **MaxiMZR** to limit the background data connection. Read the message and tap **OK**.
    - Tap  to select the apps to limit the connection of (choosing from **Infrequently used apps** or **All apps**) or to view the data usage information.
  - **Sleep** to set the Sleep setting to 15 seconds.
  - **Brightness** to decrease the display brightness.
  - **Wallpaper** to change to the Eco wallpaper.
  - **Vibrate on touch** to turn off the vibration feedback.
  - **Auto-rotate screen** to turn off automatic screen rotation.



Configured settings in the Eco Mode are automatically reflected in the respective Settings menu, and vice versa.

## Bluetooth

Bluetooth is a short-range communications technology that allows you to connect wirelessly to a number of Bluetooth devices such as headsets and hands-free car kits, Bluetooth-enabled handhelds, computers, printers, and wireless phones. The Bluetooth communication range is usually approximately 30 feet.

### Turn Bluetooth On or Off

Use the settings menu to enable or disable your phone's Bluetooth capabilities.

1. Press  >  > **Settings**.
2. Tap the **OFF** icon next to **Bluetooth** to turn Bluetooth on.



– or –

Tap the **ON** icon next to **Bluetooth** to turn Bluetooth off.

**Note:** Turn off Bluetooth when not in use to conserve battery power, or in places where using a wireless phone is prohibited, such as aboard an aircraft and in hospitals.



## The Bluetooth Settings Menu

The Bluetooth settings menu gives you access to information and controls for your phone's Bluetooth feature.

- ▶ Press  >  > **Settings** > **Bluetooth**.
  - Tap your phone name at the top of the list to make your phone visible to other devices. Tap again to cancel it. The duration your phone is visible can be changed.
  - Tap **SEARCH FOR DEVICES** to search for other visible in-range Bluetooth devices.
  - Tap  for the following menus:
    - **Rename phone** to rename your phone for Bluetooth access.
    - **Visibility timeout** to select the duration your phone is visible to other devices.
    - **Show received files** to view all files you have received via Bluetooth.
    - **Save to** to select the location to store the files to be received via Bluetooth.

## Change the Phone Name



The phone name identifies your phone to other devices.

1. Press  >  > **Settings** > **Bluetooth**.
2. If Bluetooth is not switched on, tap the **OFF** icon to turn Bluetooth on.
3. Tap  > **Rename phone**.
4. Enter the name for your phone in the dialog box and then tap **Rename**.

## Connect a Bluetooth Headset or Car Kit

You can listen to music over a Bluetooth stereo headset, or have hands-free conversations using a compatible Bluetooth headset or car kit. It's the same procedure to set up stereo audio and hands-free devices.

To listen to music with your headset or car kit, the headset or car kit must support the A2DP Bluetooth profile.

1. Press  >  > **Settings** > **Bluetooth**.
2. If Bluetooth is not switched on, tap the **OFF** icon to turn Bluetooth on. Your phone will show a list of nearby Bluetooth devices.
3. If you don't see your device listed, tap **SEARCH FOR DEVICES**. Your phone will start to scan for Bluetooth devices within range.



- Make sure that the headset is discoverable so that your phone can find the headset. Refer to the instructions that came with the headset to find out how to set it to discoverable mode.
4. When you see the name of your headset displayed on the **AVAILABLE DEVICES** list, tap the name. Your phone will then automatically try to pair with the headset.
  5. If necessary, tap **Pair** or enter the passcode supplied with your headset.
    - Tap  next to the paired device to display the information of the device. To change the name, tap **Rename**, edit the name, and then tap **OK**.

The pairing and connection status is displayed below the hands-free headset or car kit name in the Bluetooth devices section. When the Bluetooth headset or car kit is connected to your phone, the Bluetooth paired icon  is displayed in the status bar. Depending on the type of headset or car kit you have connected, you can then start using the headset or car kit to listen to music or make and receive phone calls.

**Note:** Due to different specifications and features of other Bluetooth-compatible devices, display and operations may be different, and functions such as transfer or exchange may not be possible with all Bluetooth-compatible devices.

## *Reconnect a Headset or Car Kit*



When you have paired a headset with your phone, you should be able to reconnect it automatically by turning on Bluetooth on your phone and then turning on the headset. However, sometimes you will need to reconnect manually, for example if you have been using your headset with another Bluetooth device.

1. Press  >  > **Settings** > **Bluetooth**.
2. If Bluetooth is not switched on, tap the **OFF** icon to turn Bluetooth on.
3. Make sure that the headset is discoverable.
4. Tap the headset's name in the **PAIRED DEVICES** list.
5. If prompted to enter a passcode, try 0000 or 1234, or consult the headset or car kit documentation to find the passcode.
6. If you still cannot reconnect to the headset or car kit, follow the instructions in [Disconnect or Unpair from a Bluetooth Device](#), and then follow the instructions in [Connect a Bluetooth Headset or Car Kit](#).

## *Disconnect or Unpair from a Bluetooth Device*



You can manually disconnect or unpair from a Bluetooth device through the Bluetooth settings menu.

## Disconnect a Bluetooth Device

1. Press  >  > **Settings** > **Bluetooth**.
2. On the **PAIRED DEVICES** list, tap the device to disconnect.
3. Tap **OK**.

## Unpair from a Bluetooth Device

You can make your phone forget its pairing connection with another Bluetooth device. To connect to the other device again, you may need to enter or confirm a passcode again.



1. Press  >  > **Settings** > **Bluetooth**.
2. On the **PAIRED DEVICES** list, tap  next to the device to unpair.
3. Tap **Unpair**.



## Send and Receive Information Using Bluetooth

You can use Bluetooth to transfer information between your phone and another Bluetooth-enabled device such as a phone or notebook computer. The first time you transfer information between your phone and another device, you need to enter or confirm a security passcode. After that, your phone and the other device are paired and you will not need to exchange passcodes to transfer information in the future.

### Send Information from Your Phone to Another Device



You can send the following types of information, depending on the device you are sending to:

- Images and videos
  - Contacts
1. Set the receiving device to discoverable mode. You may also need to set it to “Receive Beams” or “Receive Files”. Refer to the device’s documentation for instructions on receiving information over Bluetooth.
  2. On the phone, open the application that contains the information or file you want to send. For example, if you want to send a saved picture, press  >  > **Gallery**.
  3. Follow the steps for the type of item you want to send:
    - **Picture or video** (in Camera): After taking a picture or video, tap the thumbnail and then tap  > **Bluetooth**.

- **Pictures and videos** (in Gallery): On the Albums screen, tap an album. Touch and hold a picture or video to place a check mark on it. Tap multiple pictures and videos to select them. Tap  > **Bluetooth**.
  - **Contact**: Display a contact and tap  > **Share** > **Bluetooth**.
4. If you are prompted to turn on Bluetooth, tap **Turn on**.
  5. Tap the name of the receiving device.
  6. If prompted, accept the connection on the receiving device and enter the same passcode on both your phone and the other device or confirm the auto-generated passcode.
  7. On the receiving device, accept the file.

## Receive Information from Another Device

Your phone is capable of receiving a wide variety of file types with Bluetooth including pictures, videos, or contacts.

1. Press  >  > **Settings** > **Bluetooth**.
2. If Bluetooth is not switched on, tap the **OFF** icon to turn Bluetooth on.
3. Tap your phone name to make your phone visible to unpaired devices.
4. On the sending device, send one or more files to your phone. Refer to the device's documentation for instructions on sending information over Bluetooth.
5. If prompted, enter the same passcode on both your phone and the other device or confirm the auto-generated passcode. A Bluetooth authorization request is displayed on your phone. Tap **OK**.
6. When your phone receives a file transfer request notification, slide down the Notifications panel, tap the notification, and then tap **Accept**.
7. When a file is transferred, a notification is displayed. To open the file immediately, slide down the Notifications panel and then tap the relevant notification.

When you open a received file, what happens next depends on the file type:

- For a vCard contact file, if there are multiple vCard files on your storage card, you can choose to import one, several, or all of those contacts to your contacts list.

## Near Field Communication (NFC) Technology

NFC (Near Field Communication) technology is a short-range, wireless technology that lets you quickly and wirelessly exchange information between your phone and other NFC-enabled





smartphones and smart accessories. You can also use NFC technology to save, view, create, or change smart tags.

To use NFC technology on your phone, your phone must be within approximately 0.78 in. (2 cm) of the NFC-enabled smartphone, smart accessory, or smart tag that you want to exchange information with. When information is transferred over an NFC connection, your smartphone vibrates.

## Turn NFC On or Off

Use the settings menu to enable or disable your phone's NFC capabilities.

1. Press  >  > **Settings** > **More....**
2. Tap **NFC** to place a check mark in the adjacent checkbox to turn NFC on. If a security reminder appears, read it and tap **OK**.



– or –

Tap **NFC** to clear a check mark in the adjacent checkbox to turn NFC off.

## Android Beam

With Android Beam, you can beam app content such as Browser pages, YouTube videos, and Contacts entries, to another NFC-capable device by holding the devices close together.

To turn Android Beam on or off:

1. Press  >  > **Settings** > **More....**
2. Tap **NFC** to turn NFC on, if it is off.
3. Tap **Android Beam**.
4. Tap the **OFF** icon to turn Android Beam on.

– or –

Tap the **ON** icon to turn Android Beam off.

To share app contents:

1. With Android Beam turned on, display the contents you want to share on your screen.
2. Bring your phone close to another NFC-enabled device, typically back to back aiming the NFC antenna, and then tap your screen. The app determines what gets beamed.



## DiXiM Player

DiXiM for Android is a useful application for sharing videos, music and images across DLNA<sup>®</sup>-supported networked devices connected to your home network.

### Start the DiXiM Server



1. Press  >  > **DiXiM Player**.
2. Read a message and tap **OK**.

– or –

Tap **Wi-Fi Settings** if you have not established a Wi-Fi connection. Once you are connected to a Wi-Fi network, press .

3. Tap **Start Server**, read the message and tap **Yes**.
  - Tap **Stop Server** when you finish.

### Share or Upload Files in Gallery With DiXiM

1. Start the DiXiM server. See [Start the DiXiM Server](#).
2. Press  >  > **Gallery** and open the file you want to share or upload.
3. Tap  > **Share with DiXiM** or **Upload with DiXiM**.
4. Your phone will search for DLNA devices on your network. Tap a device to connect.

### DiXiM Server Settings

1. Press  >  > **DiXiM Player**.

2. Tap  on the top left of the screen and tap **Apps settings > DiXiM Server Settings**.
3. Configure the following settings:
  - **DiXiM Server** to start or stop the DiXiM server.
  - **Server Name** to set your server name to be displayed on other DLNA devices.
  - **Access Rights Settings** to specify the access rights of connected devices.
  - **Save Target Settings** to select where to save the files.
  - **Public Folder Settings** to set up a public folder to share among connected devices.
  - **Wi-Fi Settings** to access the Wi-Fi settings.
  - **Startup Message** to select whether to display the startup message.
  - **Auto Exit settings** to specify when to exit automatically.

For more details on DiXiM Player, tap  > **Products Information**, or visit the DigiOn website (see [www.digion.com/index.htm.en](http://www.digion.com/index.htm.en)).

## *microSD Card*

A microSD™ card is an optional accessory that allows you to store images, videos, music, documents, and voice data. Your phone supports a microSD card up to 32GB.

### *Insert or Remove a microSD Card*

Inserting a compatible microSD card into your phone will increase the storage capacity.

To insert a microSD card:

1. Locate and open the cover to the microSD card/SIM card slots on the side of the phone.

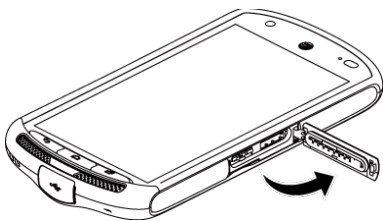

2. Carefully insert a microSD card into the microSD card slot on the right with the gold terminals facing up. Gently push the card into the slot and close the cover.

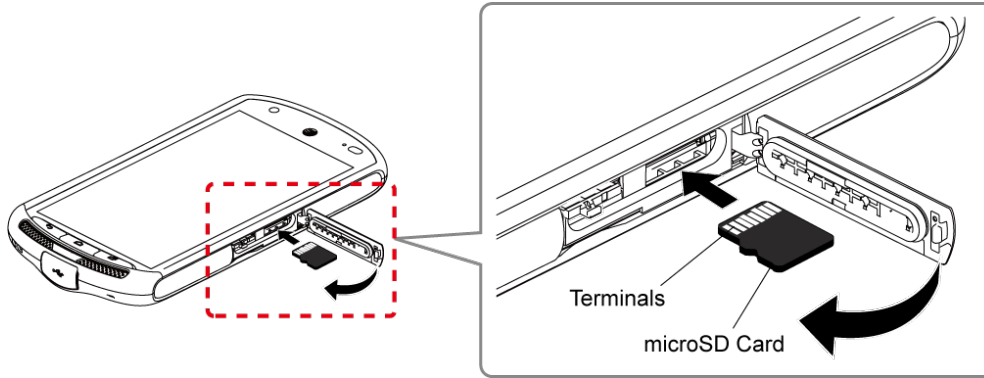

3. Press around the edges of the cover to the microSD card/SIM card slots to ensure that it is securely closed.

**Warning:** Be sure all ports and covers are properly sealed to maintain the phone's waterproof capability.

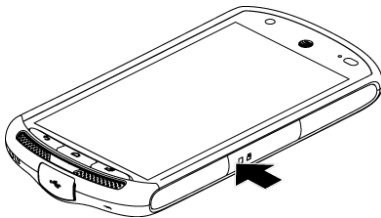

To remove a microSD card:

1. You need to unmount the microSD card before removing it while the power is still on. See [Unmount the microSD Card](#). Locate and open the cover to the microSD card/SIM card slots on the side of the phone.

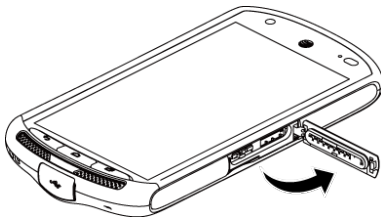

2. Push the microSD card and the card is partly ejected. Gently pull out the card from the slot and close the cover.

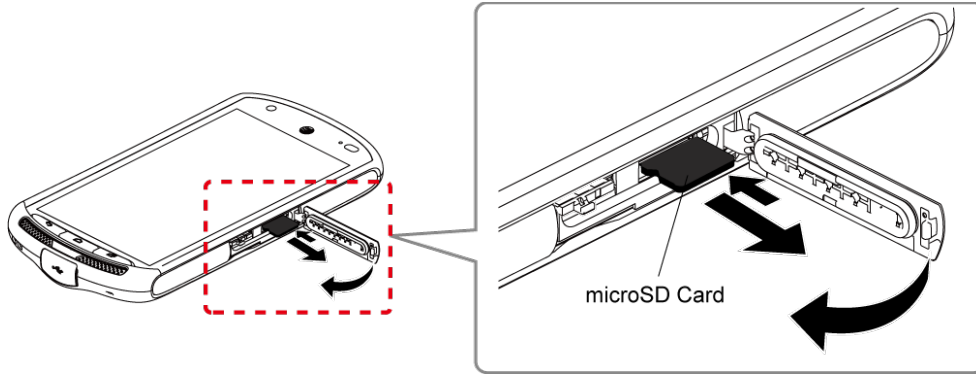

3. Press around the edges of the cover to the microSD card/SIM card slots to ensure that it is securely closed.

**Warning:** Be sure all ports and covers are properly sealed to maintain the phone's waterproof capability.

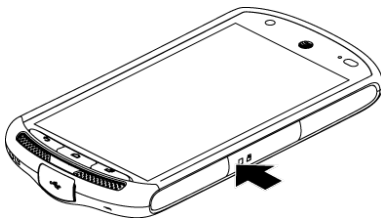

**Note:** You can easily damage the microSD card by improper operation. Please be careful when inserting, removing, or handling the microSD card.

**Note:** Make sure your battery is fully charged before using the microSD card. Your data may become damaged or unusable if the battery runs out while using the microSD card.

### *View the microSD Card Memory*

The Storage settings menu gives you access to your microSD card memory information.

1. With the microSD card installed, press > > **Settings** > **Storage**.
2. Scroll down the screen to see the information under SD CARD.

### *Format the microSD Card*

Formatting a microSD card permanently removes all files stored on the card.

1. Press > > **Settings** > **Storage**.
2. Scroll down the screen, tap **Erase SD card** > **Erase SD card** > **Erase everything**.

**Note:** The formatting procedure erases all the data on the microSD card, after which the files **CANNOT** be retrieved. To prevent the loss of important data, please check the contents before you format the card.

## Unmount the microSD Card

Unmount the microSD card to prevent corrupting the data stored on it or damaging the microSD card.

1. Press  >  > **Settings** > **Storage**.
2. Tap **Unmount SD card** > **OK**.

## Use the Phone's microSD Card as a Media Device



You can connect your phone as a media device to your computer.

1. Connect the phone to your computer using the supplied USB cable.
2. Slide the status bar down to open the Notifications panel and tap the USB connection notification.
3. Tap **Media device (MTP)**. On your computer, the connected phone is recognized as a portable media device. See [Connectivity Settings](#).
4. Navigate to the device and select **SD card**.
5. Manage the data as you wish, unmount the phone as required by your computer's operating system to safely remove your phone, and disconnect the phone from the computer.

## File Manager

With the File Manager application, you can manage the contents stored in the phone or on the microSD card (optional) quickly and easily.

To open the File Manager:

1. Press  >  > **File Manager**.
2. The following options are available. Tap a tab, or scroll right or left on the screen, to display the contents:
  - **Images:** Stores still image files.
  - **Videos:** Stores video files.
  - **Audio:** Stores the audio files.
  - **Folders:** Stores files by folder.

To manage the contents (available options may vary):

- ▶ Tap a folder or file to access it.

- ▶ Tap  for the following options:
  - **Sort:** Sorts folders or files by date, name, size, or type.
  - **View:** Changes how the folders and files are displayed.
  - **Add folder:** Creates a new folder.
  - **Copy:** Copies folders and files.
  - **Move:** Moves a folder or file to another location.
  - **Delete:** Deletes folders or files.
  - **Search:** Searches folders or files.
  - **Storage capacity:** Opens the Storage settings menu. See [Storage Settings](#).
  - **Reload:** Reloads the data.
- ▶ Touch and hold a folder or file for the following options:
  - **Share:** Shares the file using applications such as Bluetooth and Email.
  - **Copy:** Copies the folder or file.
  - **Move:** Moves the folder or file to another location.
  - **Delete:** Deletes the folder or file.
  - **Edit folder name/Edit file name:** Changes the folder or file name.
  - **Set as:** Sets the file as the Contacts image or wallpaper (still image file only).
  - **Use as phone ringtone:** Uses the file as the phone ringtone (audio file only).
  - **Details:** Shows the details of the folder or file such as size, format, or date.

## *Update Your Phone*

From time to time, updates may become available for your phone. You can download and apply updates through the system updates menu.

- ▶ Press  >  > **Settings** > **About phone** > **System updates** > **Check for Update**.

# Settings

---

The following topics provide an overview of items you can change using your phone's **Settings** menus.

## Wi-Fi Settings

The Wi-Fi settings menu lets you turn Wi-Fi on or off, set up and connect to available Wi-Fi networks, and configure advanced Wi-Fi options. For more information about the Wi-Fi settings, see [Wi-Fi](#).

## Bluetooth Settings



Your phone's Bluetooth capabilities let you use wireless headsets, send and receive pictures and files, and more. For details on your phone's Bluetooth settings, see [The Bluetooth Settings Menu](#).

## Data Usage Settings



The Data usage menu lets you view your phone's data usage and restrict hotspot usage.

### Enable Auto-sync Feature

Enabling the Auto-sync feature allows your phone to sync all apps automatically.

1. Press  >  > **Settings** > **Data usage**.
2. Tap  and select the **Auto-sync data** check box.

### View Data Usage



1. Press  >  > **Settings** > **Data usage**.
2. Confirm **Mobile data access** is set to on.
3. Tap  next to **Data usage cycle** to change the period of time for which the chart will display the data usage.
4. Tap either of the black lines on the chart to display the tabs. Drag the black tabs horizontally to see the data usage of a specific period within the displayed cycle.
  - The usage amount will be displayed below the chart followed by the usage amount by each application. Tap an application to see further details.

### Limit Mobile Data Usage

You can set a limit to your data usage in case you don't have an unlimited data plan.



**Warning:** The usage displayed is measured by your phone. Your carrier's data usage accounting may differ and the usage in excess of your data limit plan can result in charges. The data usage limit set in this menu is not guaranteed to prevent additional charges.

1. Press  >  > **Settings** > **Data usage**.
2. Select the **Limit mobile data usage** check box. Read the message and tap **OK**.
3. Drag the red tab vertically to set the limit you want.



– or –

Tap the red line, select the limit by scrolling the value, and then tap **Set**.

- When your data usage reaches the limit, mobile data will be turned off automatically.

### Alert About Data Usage

Your phone will warn you with an alert when the mobile data usage reaches a set level.

1. Press  >  > **Settings** > **Data usage**.
2. Select the **Alert me about data usage** check box. Read the message and tap **OK**.
3. Drag the orange tab vertically to set the level when you want to receive a warning.



– or –

Tap the orange line, select the limit by scrolling the value, and then tap **Set**.

- When your data usage reaches the set level, your phone will alert you.



### Data Roaming

You can enable data roaming.

1. Press  >  > **Settings** > **Data usage**.
2. Tap  and select the **Data roaming** check box.
3. Read the message and tap **OK**.

### Restrict the Background Data Usage

You can restrict the background data usage.



1. Press  >  > **Settings** > **Data usage**.
2. Tap  and select the **Restrict background data** check box.

3. Read the message and tap **OK**.

**Tip:** You can see the Wi-Fi usage. Tap  and select the **Show Wi-Fi usage** check box.

## Restrict the Background Data Usage on Wi-Fi Network

You can select Wi-Fi networks, which are mobile hotspots, to restrict the background usage of those networks.

1. Press  >  > **Settings** > **Data usage**.
2. Tap  > **Mobile hotspots**.
3. Select the check box of the Wi-Fi network to restrict.

**Tip:** Some applications may provide a warning before using these Wi-Fi networks for large downloads.

## More Settings

The Settings menu provides access to additional wireless and network options such as Airplane Mode, mobile networks, VPN, roaming, NFC, and more.



### Airplane Mode

Airplane Mode allows you to use many of your phone's features, such as Gallery, Camera, and Music, when you are on an airplane or in any other area where making or receiving calls or data is prohibited. When you set your phone to Airplane Mode, it cannot send or receive any calls or access online information.

To quickly turn Airplane Mode on or off:

- ▶ Press and hold the **Power/Lock** key, and then tap **Airplane mode**. While in Airplane Mode, the status bar will display .

To turn Airplane Mode on or off in Settings:

1. Press  >  > **Settings** > **More....**
2. Tap **Airplane mode** to place or clear a check mark in the adjacent checkbox to turn Airplane Mode on or off. While in Airplane Mode, the status bar will display .

### Default SMS App

When your phone is installed with more than one SMS app, you can specify which one to use as default for sending and receiving SMS messages.

1. Press  >  > **Settings** > **More...** > **Default SMS app**. A list of all SMS apps on your phone is displayed.

2. Select the app you want to set as default.

## *NFC Settings*

The NFC (Near Field Communication) settings menu lets you turn NFC on or off. For more information about the NFC settings, see [Near Field Communication \(NFC\) Technology](#).

## *Android Beam*

Android Beam uses the NFC technology. For more information about the Android Beam settings, see [Android Beam](#).

## *Tethering & Portable Hotspot Settings*

Use the settings menu to configure your portable Wi-Fi hotspot settings which allow you to share your phone's data service with multiple Wi-Fi capable devices. You can also share your phone's Internet connection via a USB cable or Bluetooth. For details on your phone's tethering and portable Wi-Fi hotspot settings, see [Tethering](#) and [Portable Wi-Fi Hotspot](#).



## *VPN Settings*

A virtual private network (VPN) is a network that uses a public telecommunication infrastructure, such as the Internet, to provide remote offices or individual users with secure access to their organization's network. For more information about the VPN settings, see [Virtual Private Networks \(VPN\)](#).

## *Mobile Networks Settings*



The Mobile networks options let you enable your phone's mobile data access, set your preferred network mode, and select network operators for international use.

### *Mobile Data Access*

1. Press  >  > **Settings** > **More...** > **Mobile networks**.
2. Select the **Data enabled** check box.



### *Data Roaming*

You can connect to the data services while roaming.

1. Press  >  > **Settings** > **More...** > **Mobile networks**.
2. Select the **Data roaming** check box.
3. Read the message and tap **Yes**.

### *Network Mode*



You can select your preferred network mode with this menu.

1. Press  >  > **Settings** > **More...** > **Mobile networks** > **Network mode**.
2. Select a network mode from the displayed options.



## Access Point Names

You can edit existing access points or add a new point.





To edit an existing access point:

3. Press  >  > **Settings** > **More...** > **Mobile networks** > **Access Point Names**.
4. Tap an access point you want to edit.
5. Edit the necessary fields and tap  > **Save**.



To delete an existing access point:

1. Press  >  > **Settings** > **More...** > **Mobile networks** > **Access Point Names**.
2. Tap an access point you want to delete.
3. Tap  > **Delete APN**.

To add a new access point:



1. Press  >  > **Settings** > **More...** > **Mobile networks** > **Access Point Names**.
2. Tap  and enter the necessary information.
3. Tap  > **Save**.

To restore the default settings:

1. Press  >  > **Settings** > **More...** > **Mobile networks** > **Access Point Names**.
2. Tap  > **Reset to default**.

## Network Operators

You may select a network operator.

1. Press  >  > **Settings** > **More...** > **Mobile networks** > **Network operators**.
2. Select an option:
  - **Search networks:** Searches available networks. Select the network you want to use from the available network list.

- **Choose automatically:** Selects a preferred network automatically.

## Emergency Alerts

Your phone is compatible with the federally supervised cell phone alert services to send out broadcast SMS messages for public warning.

To display the Emergency Alerts:

- ▶ Press  >  > **Emergency Alerts**.

To configure the Emergency Alerts settings:

1. Press  >  > **Emergency Alerts** >  > **Settings**.



– or –

Press  >  > **Settings** > **More...** > **Emergency Alerts**.



2. The following options are available:

- **Presidential:** Receives an emergency presidential alert. (Presidential is always grayed out [not selectable] and cannot be excluded.)
- **Imminent Threat - Extreme:** Receives emergency alerts in an extreme emergency situation (an extraordinary threat to life or property).
- **Imminent Threat - Severe:** Receives emergency alerts in a severe emergency situation (a significant threat to life or property).
- **Amber:** Receives alerts related to missing or endangered children.
- **Help:** Displays the help information for Emergency Alerts.
- **Notifications:** Receives notifications when you receive an emergency alert.
- **Sound:** Plays a sound when you receive an emergency alert.
- **Vibrate:** Vibrates your phone when you receive an emergency alert.
- **Alert reminder:** Sets how often your phone alerts you: Choose from **Once**, **Every 2 minutes**, **Every 15 minutes**, or **Off**.
- **Emergency notification preview:** Plays a sample emergency alert tone. Tap **Stop** to stop the sound.
- **Speak alert message:** Uses the text-to-speech feature to read out the emergency alert messages.

To delete an Emergency Alert:

1. Press  >  > **Emergency Alerts**.
2. Tap an entry to display the message.
3. Tap  > **Delete emergency alert** > **Delete**.

To delete all Emergency Alerts:



1. Press  >  > **Emergency Alerts**.
2. Tap  > **Delete emergency alerts** > **Delete**.

## Sound Settings

The Sound settings menu lets you control your phone's audio, from ringtones and alerts to tap tones and notifications.

### Volumes



Configure your phone's volume settings.

1. Press  >  > **Settings** > **Sound** > **Volumes**.
2. Use the sliders to set the volume level for **Music, video, games, & other media**; **Ringtone & notifications**; **Alarms**; or **System**.
3. Tap **OK** to save your settings.

**Tip:** You can adjust the ringtone volume in standby mode (or the hearing volume during a call) using the volume key on the left side of your phone.



### Vibrate Intensity

Configure the strength of vibration.

1. Press  >  > **Settings** > **Sound** > **Vibrate intensity**.
2. Select **Weak**, **Medium**, or **Strong**.
3. Tap **OK**.



### Music Effects

You have an option to select an equalizer when the equalizer app is installed on your phone.

1. Press  >  > **Settings** > **Sound** > **Music effects**.
2. Select the equalizer you want to use from the displayed list.



## Phone Ringtone

Assign a ringtone to your incoming calls.

1. Press  >  > **Settings** > **Sound** > **Phone ringtone**.
2. Tap a ringtone from the list. The ringtone briefly plays when selected.  
– or –  
Tap **Add** and select a sound data.
3. Tap **OK** to assign the ringtone.



## Vibrate Pattern

Select a vibration pattern.

1. Press  >  > **Settings** > **Sound** > **Vibrate pattern**.
2. Tap a vibrate pattern from the list. Your phone briefly vibrates when selected.
3. Tap **OK** to assign the vibrate pattern.





## Vibrate When Ringing

Set your phone to ring and vibrate simultaneously.

1. Press  >  > **Settings** > **Sound**.
2. Select the **Vibrate when ringing** check box.

## Persistent Alerts



Set alerts such as beep, vibration, or LED blinking for notifications.

1. Press  >  > **Settings** > **Sound** > **Persistent alerts**.  
– or –  
Press  >  > **Settings** > **Accessibility** > **Persistent alerts**.
2. Select the check box of the following:
  - **Audible tone** to beep when notification is on the notification bar.
  - **Vibrate** to vibrate when notification is on the notification bar.
  - **Blink LED** to blink the LED indicator when notification is on the notification bar.
3. Read the message displayed and tap **OK**.

4. Tap **OK** to assign the persistent alert type.

## *Default Notification Sound*

Select a sound for notifications.

1. Press  >  > **Settings** > **Sound** > **Default notification sound**.
2. Tap a notification sound from the list. The sound briefly plays when selected.

– or –

Tap **Add** and select a sound data.

3. Tap **OK** to assign the sound.

## *Dial Pad Touch Tones*

Play tones when using the dialpad.

1. Press  >  > **Settings** > **Sound**.
2. Select the **Dial pad touch tones** check box.

## *Touch Sounds*

Play sounds when making an onscreen selection.

1. Press  >  > **Settings** > **Sound**.
2. Select the **Touch sounds** check box.

## *Screen Lock Sound*

Play sounds when locking and unlocking the screen.

1. Press  >  > **Settings** > **Sound**.
2. Select the **Screen lock sound** check box.

## *Vibrate on Touch*



Vibrate the phone when touching the Apps key or touching and holding the empty space on the Home screen, etc.

1. Press  >  > **Settings** > **Sound**.
2. Select the **Vibrate on touch** check box.

## *Hearing Aid*



Use the hearing aid device effectively.



1. Press  >  > **Settings** > **Sound**.
2. Select the **Hearing aid** check box.

## SD Card Notifications

Set a notification tone to sound when a SD card is inserted or removed.



1. Press  >  > **Settings** > **Sound**.
2. Select the **SD card notifications** check box.

## Display Settings

Adjusting your phone's display settings not only helps you see what you want, but it can also help increase battery life.

### Brightness

Adjust your screen's brightness to suit your surroundings.

1. Press  >  > **Settings** > **Display** > **Brightness**.
2. Tap **Auto** to set the brightness automatically. The auto brightness icon  is displayed.

– or –

Use the slider to set the brightness. The manual brightness icon  is displayed.





### Wallpaper

Select and assign your phone's background wallpaper. See [Change the Wallpaper](#).

### Auto-Rotate Screen



Your phone is capable of automatically changing the orientation of some onscreen content. With this feature, you can view the screen in either portrait or landscape orientation by turning the phone sideways. By default, the screen orientation automatically changes when the phone is rotated.

To deactivate the Auto-rotate screen feature:

1. Press  >  > **Settings** > **Display**.  
– or –  
Press  >  > **Settings** > **Accessibility**.
2. Clear the **Auto-rotate screen** check box.







## Sleep

Select the delay time before the screen automatically turns off.

1. Press  >  > **Settings** > **Display** > **Sleep**.
2. Select a delay time.



## Daydream

You can set a screen saver to your phone.

1. Press  >  > **Settings** > **Display** > **Daydream**.
2. If Daydream is not switched on, tap the **OFF** icon to turn it on.
3. Tap one of the below options:
  - **Clock** to display the phone's analog or digital clock. Tap  next to it and select the clock style or select the **Night mode** option.
  - **Colors** to display changing colors.
  - **Google Photos/Photo Frame** to display the images as a slide show. Tap  next to them and select the images to display.
  - **Photo Table** to scatter the images one by one across the screen to make a collage. Tap  next to it and select the images to display.
4. Press  to go back to the Daydream screen, if necessary, and tap **WHEN TO DAYDREAM** to select when the screen saver is displayed from: **While docked**, **While charging**, or **Either**.
  - To see the preview, tap **START NOW**.

## Change Text Font

Choose the font to be displayed.

1. Press  >  > **Settings** > **Display** > **Change text font**.
2. Select your favorite font. The sample characters of the selected font are displayed in the preview window above the available options.
3. Tap **OK**.

## Font Size



Choose the font size of the screen as you like.

1. Press  >  > **Settings** > **Display** > **Font size**.

2. Select your favorite size.



## Key Backlight

Select the delay time before the key backlight automatically turns off.

1. Press  >  > **Settings** > **Display** > **Key backlight**.
2. Select a delay time.



## Display Battery Percentage

Set your phone to display the battery percentage on the status bar.

1. Press  >  > **Settings** > **Display**.
2. Select the **Display battery percentage** check box.

## Wireless Display

You can connect your phone to the devices that support Miracast to share the displayed images via Wi-Fi connection.

1. Press  >  > **Settings** > **Display** > **Cast screen**.
2. If Wireless display is not switched on, tap  and select the **Enable wireless display** check box to turn it on. Available devices will be displayed.
3. Select a device you want to connect to from the list.

**Note:** For more information about wireless display, see the documentation that comes with the Miracast-certified device you wish to use with your phone.

## Programmable Key

You can assign your favorite behavior to the programmable key. Press and hold the key to call up the assigned function.

1. Press and hold the programmable key on the side of the phone. If a message appears to ask whether you assign a function to the key, tap **Assign**.

– or –

Press  >  > **Settings** > **Programmable key**.



2. Tap **Programmable key**.
3. Tap the function you want to assign to the key.

## Storage Settings

The Storage settings menu lets you manage the storage on your phone and provides options for your microSD card.



### Your Phone's Memory

You can see the availability of the storage space on your phone.

- ▶ Press  >  > **Settings** > **Storage**.
  - View your phone's total space and the space used by specific features under PHONE.
  - You may tap an itemized category for additional details.

### Manage Media Files

Media files stored on your phone can be easily moved to the inserted microSD card. This menu option is active only when a microSD card is inserted.

1. Press  >  > **Settings** > **Storage** > **Manage media files**.
2. Check the items you want to move to the microSD card and tap **Move**.



### SD Card

The SD card options let you view the card's size and available space, unmount the card for data protection, and format (erase) the SD card. See [microSD Card](#).

### USB Storage



The USB storage options are available when your phone is connected to an external device using a USB cable.

#### View the USB Storage Memory

1. Press  >  > **Settings** > **Storage**.
2. Scroll down the screen to see the information under USB STORAGE.



#### Unmount the USB Storage

Unmount the USB storage so that you can safely remove it.

1. Press  >  > **Settings** > **Storage** > **Unmount USB storage**.
2. Read the message and tap **OK**.



## Erase the Data on the USB Storage

**Warning:** You cannot retrieve the data once deleted.



1. Press  >  > **Settings** > **Storage** > **Erase USB storage**.
2. Read the message and, if you are sure about the deletion, tap **Erase USB storage**.
3. Read another message and, if you are sure about the deletion, tap **Erase everything**.

## Battery Settings

Monitor your phone's battery usage through this settings menu. View which functions are consuming your battery's charge and at what percentage.



- ▶ Press  >  > **Settings** > **Battery** > **Battery status**.
  - Tap [# of hours, minutes and seconds] **on battery** to see the history details of the battery usage.
  - Tap other displayed items to access their Use details screens. Additional options may be available.
  - Tap  to refresh the displayed information.

## Battery Charging Notifications

1. Press  >  > **Settings** > **Battery**.
2. The following options are available:
  - **Battery charging tone:** Check to sound a notification tone when the charging starts.
  - **Battery charged tone:** Check to sound a notification tone when the battery is fully charged.

## Connectivity Settings



Set your phone's default connection mode when connected to another device.

1. Press  >  > **Settings** > **Connectivity**.
2. Select an option:
  - **Media device (MTP)** to transfer media files on Windows or use Android File Transfer on Mac (see [www.android.com/filetransfer](http://www.android.com/filetransfer)).

- **Camera (PTP)** to transfer pictures using camera software and also transfer files on computers that do not support MTP.
- **Charge only** to charge the battery.
- **USB tethering** to use your phone to connect your computer to the Internet.

## Apps Settings

This menu lets you view and manage the applications on your phone.

1. Press  >  > **Settings** > **Apps**.
2. Swipe the screen to the left to access the following tabs:
  - **DOWNLOADED** to display the downloaded applications. You can also see the internal storage status on your phone at the bottom of the screen.
  - **ON SD CARD** to display the applications stored on the microSD card. You can also see the SD card storage status at the bottom of the screen.
  - **RUNNING** to display the applications currently running on your phone. You can also see the RAM status on your phone at the bottom of the screen.
  - **ALL** to display all applications on your phone. You can also see the internal storage status on your phone at the bottom of the screen.

**Tip:** Additional options may be available by tapping  on each tab.

3. Tap an application to access the details and manage it.



## Tap & Pay

When NFC is turned on, you can use the Tap & pay feature to pay for items just by touching your phone to a reader at a register. If your phone doesn't have a default app, you can browse Google Play for payment apps. See [Turn NFC On or Off](#) for enabling NFC.

1. Press  >  > **Settings** > **Tap & pay**.
2. Select an app to use.

## Location Settings

The location settings menu lets you decide whether you allow your phone to collect and use the location information.

1. Press  >  > **Settings** > **Location**.
2. Tap the **OFF** icon.

3. Read the message in the **Location consent** dialog box and, if you agree to it, tap **Agree**.
4. Read another message in the **Location consent** dialog box and, if you agree to it, tap **Agree**.

## Lock Screen Settings

The lock screen settings menus allow you to lock your phone's screen and enhance the security feature through various options.

### Screen Lock



You can increase the security of your phone by creating a screen lock.

From least secure to most secure, the available options are:

- **None** – No security
- **Swipe** – No security
- **Face Unlock** – Low security
- **Pattern** – Medium security
- **PIN** – Medium to high security
- **Password** – High security

**Important:** Highest security level protection (password protection) and frequent change of password are recommended to protect your phone and data from unauthorized access.



### Use Face Unlock

1. Press  >  > **Settings** > **Lock screen** > **Screen lock** > **Face Unlock**.
2. Read the message displayed and tap **Set it up**.
3. Read the message displayed and tap **Continue**.
4. Using the front camera, adjust the phone so that your face fits in the area outlined with the dots on the screen.
5. The message “**Face captured.**” appears when the Face Unlock set up was successful. Tap **Continue**.
6. You will be prompted to set up a backup lock. Select **Pattern** or **PIN** and set it up. See [Use Pattern](#) or [Use PIN](#).

To unlock the screen with Face Unlock:

- ▶ Turn on the phone and look at the front camera so that it recognizes you.
  - If it fails to recognize you, a backup lock screen appears. Enter a pattern or PIN to unlock.

## Use Pattern

1. Press  >  > **Settings** > **Lock screen** > **Screen lock** > **Pattern**.
2. Draw the screen unlock pattern by connecting at least four dots in a vertical, horizontal, or diagonal direction. Lift your finger from the screen when finished.
3. The phone records the pattern. Tap **Continue**.
4. When prompted, draw the screen unlock pattern again and then tap **Confirm**.
5. You will be prompted to choose your backup PIN. See [Use PIN](#).

To unlock the screen with Pattern:

- ▶ Draw the pattern on the locked screen.

**Note:** Clear the **Make pattern visible** check box if you do not want the unlock pattern to display on the screen when you draw it.



## Use PIN

1. Press  >  > **Settings** > **Lock screen** > **Screen lock** > **PIN**.
2. Enter a PIN, tap **Continue**, re-enter your PIN, and tap **OK** to save the setting.

To unlock the screen with PIN:

- ▶ Enter the PIN and tap **OK** on the locked screen.

## Use Password

1. Press  >  > **Settings** > **Lock screen** > **Screen lock** > **Password**.
2. Enter a password, tap **Continue**, enter your password again, and tap **OK** to save the setting.

To unlock the screen with Password:

- ▶ Enter the password and tap **Done** on the locked screen.

## Disable the Screen Lock

1. Press  >  > **Settings** > **Lock screen** > **Screen lock**.



2. Confirm your pattern, PIN, or password.
3. Tap **None** or **Swipe**.

## Use Swipe



There is no security using the Swipe option.

- ▶ Press  >  > **Settings** > **Lock screen** > **Screen lock** > **Swipe**.

See [Turn the Screen On and Start with Swipe](#) for starting with Swipe.



## Improve Face Matching

Capture your face in different conditions to improve the face matching ability of the Face Unlock feature.

1. Press  >  > **Settings** > **Lock screen** > **Improve face matching**.
2. Enter a pattern, or enter PIN, and tap **Next**.
3. Read the instructions and tap **Continue**.
4. Capture your face.
5. When the message "**Face captured.**" appears, tap **Done**.



## Liveness Check

Enabling this option requires you to blink when unlocking the screen with the Face Unlock feature.

1. Press  >  > **Settings** > **Lock screen**.
2. Select the **Liveness check** check box.
3. To unlock, blink your eyes when "**Blink now**" appears on the screen.

## Make Pattern Visible

You can hide the trace of your pattern as you draw it.

1. Press  >  > **Settings** > **Lock screen**.
2. Clear the **Make pattern visible** check box.

## Screen Lock Time



Set the delay time the screen lock feature activates after it goes to sleep.

1. Press  >  > **Settings** > **Lock screen** > **Screen lock time**.

2. Select the delay time to lock the screen.

## Power Key Instantly Locks

Activate the screen lock feature by pressing the **Power/Lock** key.

1. Press  >  > **Settings** > **Lock screen**.
2. Select the **Power button instantly locks** check box.

## Show Instructions

You can select to display the instructions for the Swipe option.

1. Press  >  > **Settings** > **Lock screen**.
2. Select the **Show instructions** check box.



## Enable Widgets

When the screen lock is set to Swipe, you can access the widgets which appear on the screen when you turn it on.

1. Press  >  > **Settings** > **Lock screen**.
2. Select the **Enable widgets** check box.

## Owner Information

You can display some text information on the locked screen.

1. Press  >  > **Settings** > **Lock screen** > **Owner info**.
2. Select the **Show owner info on lock screen** check box.
3. Enter the texts into the provided field.

## Security Settings



The security settings menus let you set encryption options, password visibility, administrator settings, and credential storage options.

### Encrypt & Decrypt Data

You can encrypt the data in your phone and the SD card installed in your phone. You need to enter the PIN, pattern or password for the screen lock for the operation. To set up a PIN, pattern or password, see [Screen Lock](#).

**Warning:** Refrain from using the phone, including removing the battery and the SD card, during the encryption and decryption processes as some or all of your data will be lost if the encryption and decryption processes are interrupted.



## Encryption

1. Charge the battery first.
2. With your phone connected to the power source, press  >  > **Settings** > **Security** > **Encrypt & Decrypt data**.
3. Select the target to be encrypted from **Phone & SD card**, **Phone**, or **SD card**.
4. Read the message and tap **Next**.
5. Select the level of encryption you want and tap **Next**.

**Note:** For the encryption of the SD card, you can set the level for the initial encryption only and the same level will be applied afterward.

6. Enter the PIN, pattern or password and tap **Next**.
7. Read the message and tap **Encrypt**. The encryption process starts.

## Decryption

1. Charge the battery first.
2. With your phone connected to the power source, press  >  > **Settings** > **Security** > **Encrypt & Decrypt data**.
3. Select the target to be decrypted from **Phone & SD card**, **Phone**, or **SD card**.
4. Read the message and tap **Next**.
5. Enter the PIN, pattern or password and tap **Next**.
6. Read the message and tap **Decrypt**. The decryption process starts.



## Make Passwords Visible

You can hide your password or PIN as you type it.

1. Press  >  > **Settings** > **Security**.
2. Clear the **Make passwords visible** check box.

## Reset Password



Set or change the password for performing factory data reset. See [Factory Data Reset](#). The default value is 0000.

1. Press  >  > **Settings** > **Security** > **Reset password**.
2. Enter your password and tap **Continue**.

3. Enter your new password and tap **Continue**.
4. Confirm your new password and tap **OK**.



## Device Administrators

You can enable or disable the authority to be a device administrator of certain applications. If disabled, you will typically lose some functionality in those applications such as the ability to sync new email or calendar events to your phone.

1. Press  >  > **Settings** > **Security** > **Device administrators**.
2. Tap an application you want to enable or disable the authority to be a device administrator of and then tap **Activate** or **Deactivate**.

## Unknown Sources

Follow the steps below to allow installation of non-Play Store applications.

1. Press  >  > **Settings** > **Security**.
2. Select the **Unknown sources** check box > **OK**.

## Verify Apps

Your phone will warn you before installing apps that may cause harm.

1. Press  >  > **Settings** > **Security**.
2. Select the **Verify apps** check box.

## Credential Storage

These options let you control how your phone accesses and stores secure certificates, passwords, and other credentials.



### Storage Type

You can see the supported credentials storage type.

- ▶ Press  >  > **Settings** > **Security**. You will see the type under **Storage type**.



### Trusted Credentials

You can see the trusted credentials on your phone's system.

1. Press  >  > **Settings** > **Security** > **Trusted credentials**.
2. Tap an item to read the information.

## Install from SD Card

You can install encrypted certificates from the SD card.

1. Press  >  > **Settings** > **Security** > **Install from SD card**.
2. Tap an available certificate.
3. Follow the onscreen instructions.

## Clear Credentials

You can remove all the credentials on your phone.

- ▶ Press  >  > **Settings** > **Security** > **Clear credentials** > **OK**.



## Language & Input Settings

Your phone's language and input settings let you select a language for the phone's menus and keyboards, select and configure keyboard settings, configure speech input settings, and more. For details, see [Enter Text](#).

This menu also provides the settings when using voice functions. See [Text-to-Speech](#) and [Voice Search Settings](#).



### Language Settings

The language settings menu lets you select an onscreen language and add custom words to your phone's user dictionary.

1. Press  >  > **Settings** > **Language & input** > **Language**.
2. Select **English** or **Español**.

### Spell Checker

This feature allows you to spell check text as you type it.

1. Press  >  > **Settings** > **Language & input**.
2. Select the **Spell checker** check box to enable the feature.
3. Tap  to configure the settings.

### Personal Dictionary

You can use the user dictionary option to add new words to the dictionary. See [Add a Word to the User Dictionary](#).

## Default Text Input



You can select the default method you will use when accessing the keyboard. See [Touchscreen Keyboards](#).

## Google Keyboard Settings

You can customize the Google Keyboard settings as you like.

1. On the Google Keyboard, touch and hold the key immediately left to the space key and tap **Google Keyboard Settings**.

– or –



Press  >  > **Settings** > **Language & input**, and then tap  next to **Google Keyboard**.

2. Choose from the following options.
  - **Input languages:** Tap to select the input language. The dictionary for the selected language will be enabled.
  - **Auto-capitalization:** Check to automatically set the first letter of a sentence to upper case where available.
  - **Vibrate on keypress:** Check to activate vibration when a key is tapped.
  - **Sound on keypress:** Check to activate a clicking sound when a key is tapped.
  - **Popup on keypress:** Check to display a larger image of the key above it when you tap it.
  - **Voice input key:** Check to display the voice input key on the keyboard.
  - **Personal dictionary:** Tap to access and manage your personal dictionary.
  - **Add-on dictionaries:** Tap to select the dictionary you want to use.
  - **Block offensive words:** Check to avoid potentially offensive words will be suggested.
  - **Auto-correction:** Tap to allow the space bar and punctuation to automatically correct mistyped words.
  - **Show correction suggestions:** Tap to select when correction suggestions are displayed.
  - **Personalized suggestions:** Check to learn from Google apps and services, as well as your typed data, to improve suggestions.
  - **Enable gesture typing:** Check to input a word by sliding through the letters.

- **Dynamic floating preview:** Check to display the word suggestion while using the gesture typing.
- **Show gesture trail:** Check to display the path when you slide through the letters when gesture typing.
- **Phrase gesture:** Check to input spaces during gestures by gliding to the space key.
- **Next-word suggestions:** Check to predict words based on the texts you have entered.
- **Advanced settings:** Tap to open the settings for expert users.
- **Send feedback:** Tap to submit your feedback for Google Keyboard.
- **About Google Keyboard:** Tap to display the version of the Google Keyboard and the links to the information on licenses and privacy policy.



## Google Voice Typing Settings

You can customize the Google voice typing settings as you like.

1. Press  >  > **Settings** > **Language & input**, and then tap  next to **Google voice typing**.
2. Configure the following options:
  - **Choose input languages:** Tap to select the language to use for Google voice typing.
  - **Block offensive words:** Check to replace recognized offensive words in transcriptions with [\*] when entering text by speaking.
  - **Offline speech recognition:** Tap to download the speech recognition data for offline use.

## Voice Search Settings

You can configure the settings of the voice search feature.

1. Press  >  > **Settings** > **Language & input** > **Voice Search**.
2. Configure the following options:
  - **Language:** Tap to set the language used when entering text by speaking.
  - **Speech output:** Tap to select when to use the voice search.
  - **"Ok Google" Detection:** Tap to launch Google voice search by saying "Ok Google" on the Google search screen. This feature is currently available in English only.



- **Offline speech recognition:** Tap to download the speech recognition data for offline use.
- **Block offensive words:** Check to replace recognized offensive words in transcriptions with [\*] when entering text by speaking.
- **Bluetooth headset:** Check to record audio through Bluetooth headset if available.

## *Text-to-Speech Settings*

Your phone can convert text into speech in certain downloaded applications. You may select the language you hear or adjust its speed. See [Text-to-Speech](#).

## *Pointer Speed*

Change the pointer speed.

1. Press  >  > **Settings** > **Language & input** > **Pointer speed**.
2. Use the slider to set the speed and tap **OK**.

## *Backup & Reset Settings*

Your phone's Backup & reset menus let you back up your phone's data and settings to Google servers before resetting your phone to the original factory settings.



The Factory data reset erases all data from the phone's application storage, including:

- Your Google Account
- All other email and social networking accounts
- System and application data and settings
- Downloaded applications

## *Backup & Restore*

Back up your phone's data and settings before resetting your phone.

To set your backup and restore options:



1. Press  >  > **Settings** > **Backup & reset**.
2. Select your backup and restore options.
  - **Back up my data:** Check to back up your app data, Wi-Fi passwords, and other settings to Google servers.
  - **Backup account:** Tap to set a Google Account for your phone backup.





- **Automatic restore:** Check to restore backed up settings and data when reinstalling an application after a factory data reset.

## Factory Data Reset

All the data in your phone's internal storage will be reset to default.



**Tip:** Before performing a factory data reset on your phone, you may want to unmount the microSD card to avoid losing any data you may have stored on it. Press  >  > **Settings > Storage > Unmount SD card** to unmount the storage card.

1. Press  >  > **Settings > Backup & reset > Factory data reset.**
2. Read the factory data reset information, select the **Erase SD card** check box if necessary, and tap **Reset phone**. Enter the pattern, PIN, or password for screen lock, if required. See [Screen Lock](#).
3. Tap **Erase everything**. Your phone will power down and reset itself, which may take up to 10 minutes. Enter your reset password, if required. See [Reset Password](#).



## Accounts Settings

Add and manage all your email, social networking, and picture and video sharing accounts.

### Set Up a New Account

1. Press  >  > **Settings > Add account.**
2. Tap an account type such as **Corporate, Email, Google**, etc.
3. Follow the instructions on the screen to set up an account.
  - Depending on the account type, you may need to enter an email address or user address, password, domain name, or other information. For Corporate Sync accounts, contact your server administrator to determine what information you will need.



### Manage Existing Accounts

1. Press  >  > **Settings.**
2. Tap an account type such as **Corporate, Email, Google**, etc.
3. Manage the settings or select an account. Available settings menus vary according to the account type.
  - Select a check box next to the item to sync.
  - Tap  > **Sync now** to sync immediately.

- Tap  > **Remove account** > **Remove account** to delete the account from your phone.

## Date & Time Settings

Use the Date & Time settings menu either to automatically use the network-provided date and time or manually set these values, as well as select time and date format options.



1. Press  >  > **Settings** > **Date & time**.
2. Clear the **Automatic date & time** check box if necessary.
3. Clear the **Automatic time zone** check box if necessary.
4. Tap **Set date**. Adjust the month, date, and year by scrolling each value. Tap **Done** when finished.
5. Tap **Set time**. Adjust the hour and minute and select AM or PM by scrolling each value. Tap **Done** when finished.
6. Tap **Select time zone** and then select a time zone from the onscreen list. Scroll down the list to view additional time zones.
7. Select the **Use 24-hour format** check box to use the 24-hour format.
8. Tap **Choose date format** to select how the date information is displayed on your phone.

## Accessibility Settings

The Accessibility menu lets you enable and manage accessibility-related applications.



### Services

This menu provides you with the list of accessibility-related applications.

1. Press  >  > **Settings** > **Accessibility**.
2. Tap an application and configure its settings.

### TalkBack

TalkBack provides spoken feedback to help visually impaired users.

1. Press  >  > **Settings** > **Accessibility** > **TalkBack**.
2. To turn it on, tap the **OFF** icon, read the confirmation message, and tap **OK**.
3. Tap **SETTINGS** to configure its settings.



**Note:** When TalkBack is turned on, you need to double tap or slide with two fingers, instead of single tap or slide with one finger, to operate the touchscreen.

## Vision

Configure the accessibility settings on vision.

### Magnification Gestures

You can zoom in and out by triple-tapping the screen.

1. Press  >  > **Settings** > **Accessibility** > **Magnification gestures**.
2. Read the information and tap the **OFF** icon to enable the feature.

### Large Text

Use large fonts on the screen.

1. Press  >  > **Settings** > **Accessibility**.
2. Select the **Large text** check box.

### Speak Passwords

Let your phone speak the password you enter.



1. Press  >  > **Settings** > **Accessibility**.
2. Select the **Speak passwords** check box.

### Text-to-speech Output

Your phone can convert text into speech in certain downloaded applications. See [Text-to-Speech](#).

### Color Adjustment

You can adjust the display colors by changing the hue range of red, green, and blue.

1. Press  >  > **Settings** > **Accessibility** > **Color adjustment**.
2. Tap the **OFF** icon to enable the feature.
3. Read the message and tap **OK**.
4. Use the sliders to adjust the color. The applied effects are displayed in the preview window above the sliders.

## Invert Colors

This feature inverts the colors displayed on the screen.



1. Press  >  > **Settings** > **Accessibility**.
2. Select the **Invert colors** check box.

## Hearing

Configure the accessibility settings on hearing.



## Captions

You can customize the language and the style of the displayed captions.

1. Press  >  > **Settings** > **Accessibility** > **Captions**.
2. Configure the following settings:
  - **TEXT:** Set the attributes of the texts to be displayed, such as **Language**, **Font**, **Font style**, and **Font color**.
  - **CAPTIONS WINDOW:** Set the background of the texts with **Window color** and **Opacity**.
  - **APPEARANCE:** Select the **Display** style from **Pop-on**, **Roll-up**, or **Paint-on**.



## Mono Audio

This feature converts the stereo sound into monaural sound when you use external devices such as headsets including Bluetooth devices. This feature does not apply to phone calls.

1. Press  >  > **Settings** > **Accessibility**.
2. Select the **Mono audio** check box.

## Sound Balance

Control the sound balance through the right and left speakers in the phone when you use external devices such as earphones. It does not apply to the phone calls.



1. Press  >  > **Settings** > **Accessibility** > **Sound balance**.
2. Use the slider to adjust the balance while listening to preview sound.
3. Tap **OK**.

## Mobility

Configure the accessibility settings on mobility.

## Touch & Hold Delay

Set the delay time when the screen recognizes the touch and hold operation.



1. Press  >  > **Settings > Accessibility > Touch & hold delay.**
2. Select **Short, Medium, or Long.**

## Others

Configure other accessibility settings.

### Power Button Ends Call

Use the **Power/Lock** key to end a call.



1. Press  >  > **Settings > Accessibility.**
2. Select the **Power button ends call** check box.

### Auto-Rotate Screen

Your phone is capable of automatically changing the orientation of some onscreen content. See [Auto-Rotate Screen](#).



### Accessibility Shortcut

With this feature on, you can quickly enable accessibility features.

1. Press  >  > **Settings > Accessibility > Accessibility shortcut.**
2. Read the information and tap the **OFF** icon to enable the feature.

### Phone Options Shortcut

You can add shortcuts to the phone options which appear when touching and holding the **Power/Lock** key.



1. Press  >  > **Settings > Accessibility > Phone options shortcut.**
2. Select the checkbox next to the options you want to add to the phone options.

### Persistent Alerts

Set alerts such as beep, vibration, or LED blinking for notifications. See [Persistent Alerts](#).

## Printing

You can print the data on your phone.

1. Press  >  > **Settings** > **Printing**.
2. Select a print service and follow the online instructions.

## *About Phone*

The About phone menu lets you access and view important phone information including your phone number, battery status, and legal information.

- ▶ Press  >  > **Settings** > **About phone**.

# Notes

---

- Instructions to perform tasks in this guide may change depending on the version of software or application on your phone.
- All screens in this guide are simulated. Actual displays may vary.
- Certain features, services, and applications are network dependent and may not be available in all areas; additional terms, conditions and/or charges may apply. Contact your service provider about feature availability and functionality.
- All features, functionality, and other specifications, as well as the information contained in this guide, are based upon the latest available information and are believed to be accurate at the time of printing. Kyocera Communications, Inc. reserves the right to change or modify any information or specifications without notice or obligation.
- For warranty service information, please refer to the Product Safety and Warranty Information provided with the phone or call the following telephone number from anywhere in the continental United States and Canada: 1-800-349-4478 or 858-882-1401.

## Copyright & Trademarks

---

© 2014 Kyocera Corporation. All rights reserved. KYOCERA is a registered trademark of Kyocera Corporation. All other trademarks are the property of their respective owners.

Android, Google Play, Google Maps, Gmail, and YouTube are trademarks of Google Inc.

The Bluetooth® word mark and logos are registered trademarks owned by Bluetooth SIG, Inc. and any use of such marks by Kyocera Corporation is under license. Other trademarks and trade names are those of their respective owners.

PhotoSolid®, the image stabilization technology product, is a product of Morpho, Inc. "PhotoSolid®" is a registered trademark of Morpho, Inc.

"MovieSolid®", the motion video stabilizing technology product, is a product of Morpho, Inc. "MovieSolid®" is a registered trademark of Morpho, Inc.

"TrackSolid®", the automatic object tracking technology product, is a product of Morpho, Inc. "TrackSolid®" is a registered trademark of Morpho, Inc.

"Morpho Defocus"™, the background defocus generation technology product, is a product of Morpho, Inc. "Morpho Defocus"™ is a trademark of Morpho, Inc.

"Morpho HDR"™, the high dynamic range technology product, is a product of Morpho, Inc. "Morpho HDR"™ is a trademark of Morpho, Inc.

"QuickPanorama®", the panoramic image generation technology product, is a product of Morpho, Inc. "QuickPanorama®" is a registered trademark of Morpho, Inc.

"Morpho Effect Library"™, the visual effect technology product, is a product of Morpho, Inc. "Morpho Effect Library"™ is a trademark of Morpho, Inc.



The 'Qi' symbol is a trademark of the Wireless Power Consortium.



microSD and microSDHC Logos are trademarks of SD-3C, LLC.



DLNA®, the DLNA Logo and DLNA CERTIFIED® are trademarks, service marks, or certification marks of the Digital Living Network Alliance.



# Index

---

- 3-Way calling, 31
- Accessibility
  - auto-rotating screen, 134
  - captions, 153
  - color adjustment, 152
  - invert colors, 153
  - large text, 152
  - magnification gestures, 152
  - mono audio, 153
  - persistent alerts, 132
  - phone options shortcut, 154
  - settings, 151
  - shortcut, 154
  - speak passwords, 152
  - talkback, 151
  - text-to-speech output, 111
  - touch & hold delay, 154
- Account
  - create, 150
  - manage, 150
  - settings, 150
- Airplane Mode, 127
- Alarm, 107
- Android Beam, 118
- Application Launcher, 11
- Apps
  - add shortcuts to Home screen, 13
  - remove from the Home screen, 13
  - settings, 139
- Audio jack, 2
- Back key, 2
- Backup, 149
- Backup & reset, 149
- Battery
  - charge, 5
  - charge wirelessly, 5
  - notifications, 138
  - settings, 138
- Bluetooth, 113
  - change phone name, 114
  - connect, 114
  - disconnect, 115
  - receive information, 117
  - reconnect, 115
  - send information, 116
  - settings, 113
  - share pictures and videos, 99
  - turn on or off, 113
  - unpair, 116
- Bookmarks, 86
  - add to Home screen, 87
- Browser, 81
  - Bookmarks, 86
  - Home page, 86
  - launch, 78
  - Launch connection, 81
  - Menu, 82
  - navigation, 81
  - select text on a Web page, 83
  - Settings, 84
- Calculator, 109
- Calendar, 101
  - add a task, 102
  - add an event, 101
  - edit events, 104
  - event alerts, 103
  - invite guests, 102
  - show or hide, 105
  - synchronize, 105
  - view events, 104
- Call
  - 3-Way calling, 31
  - answer, 28
  - auto answer, 38
  - auto-retry, 37
  - Call Forwarding, 32
  - call restrictions, 38
  - call timer, 38
  - Call Waiting, 31
  - Caller ID, 30

- DTMF tones, 38
- emergency numbers, 25
- end, 24, 154
- fixed dialing numbers, 36
- from Contacts, 25
- from the phone dialpad, 24
- from the Recent calls list, 25
- incoming, 35
- make, 24
- numbers with pauses, 26
- options, 29
- Plus (+) Code Dialing, 26
- quick response, 36
- receive, 27
- recent calls (call log), 33
- reject and send a message, 28
- ringtone, 35
- send to Voicemail, 28
- speed dial numbers, 25
- TTY mode, 37
- vibrate, 35
- voice privacy, 38
- Voicemail settings, 35
- Call Forwarding, 32
- Call Waiting, 31
- Caller ID, 30
- Camera, 90
  - back, 3
  - flash, 3
  - front, 2
  - settings, 93
  - take picture, 91
  - viewfinder screen, 90
- Cast screen, 136
- Charger
  - port, 2
- Clock, 106
- Clock & Weather, 15
- Contacts, 40
  - add, 41
  - add to Favorites, 45
  - assign a message ringtone, 44
  - assign a new picture, 43
  - assign a phone ringtone, 44
  - assign a stored picture, 43
  - assign a vibration, 45
  - delete, 46
  - edit, 43
  - edit group, 46
  - group, 46
  - ICE (in case of emergency), 47
  - list, 40
  - make call from, 25
  - save a phone number, 42
  - send calls to voicemail, 45
  - share, 48
  - synchronize, 48
- Data services, 78
  - connection status and indicators, 79
- Data usage
  - settings, 125
- Date & time
  - settings, 151
- Desk clock, 106
- Display
  - auto-rotating screen, 134
  - battery percentage, 136
  - brightness, 134
  - change text font, 135
  - daydream, 135
  - font size, 135, 152
  - key backlight, 136
  - settings, 134
  - sleep, 135
  - wallpaper, 14
  - wireless, 136
- DiXiM Player, 119
- Drag, 9
- Dura Grid, 16
- Eco Mode, 112
- Email, 53
  - account settings, 57
  - add a corporate account, 53
  - add an account, 53
  - general settings, 56
  - manage inbox, 56
  - reply, 55
  - send, 54

- send pictures or videos, 98
  - synchronize account, 56
  - view message, 56
- Emergency alerts, 130
- Emergency call, 25
- Factory data reset, 150
- Favorites tray, 12, 14
- File Manager, 123
- Flick, 10
- Folders, 14
- Gallery, 94
  - edit pictures, 97
  - open, 95
  - options, 96
  - share pictures and videos, 98
  - view pictures and videos, 96
  - zoom on a picture, 96
- Gmail
  - access, 51
  - read and reply, 52
  - send, 52
  - send pictures or videos, 98
- Google Account, 50
  - create, 50
  - sign in to, 51
- Google Keyboard, 20
  - text mode, 21
  - user dictionary, 22
- Google Maps, 69
- Google Play, 66
  - install apps, 66
  - open apps, 68
  - options, 67
  - Play Store, 66
  - refund, 68
  - uninstall apps, 68
- Google voice typing, 22
  - settings, 148
- Google+, 65
  - share pictures and videos, 99
- Hearing aid, 133
- Home key, 2
- Home screen, 11
  - extended, 12
- manage, 12
  - overview, 11
- Internet Calling, 27
- Keyboard
  - Google Keyboard, 20
  - Google Keyboard settings, 147
- Language & input
  - language, 146
  - pointer speed, 149
  - settings, 146
  - spell checker, 146
  - user dictionary, 22
- Launcher screens, 16
- LED indicator, 2
- Light sensor, 2
- Location
  - settings, 139
- Lock screen
  - settings, 140
- Microphone
  - primary, 2
  - secondary, 2
- microSD card, 120
  - format, 122
  - insert, 120
  - remove, 121
  - slot, 2
  - unmount, 122
  - use as a media device, 122
  - view the memory, 122
- MMS
  - Options, 63
  - Send messages, 59
- Mobile networks, 128
- Music, 71
  - back up, 75
  - Music Player, 71
  - Play Music, 74
- Music Player, 71
  - play, 72
  - playlist, 73
- NFC (Near field communication), 117
  - Android Beam, 118
  - tap & pay, 139

- Notification
  - panel, 18
- Notification Icons, 18
- Notifications, 18
- Phone
  - back up, 149
  - factory data reset, 150
  - hard reset, 7
  - illustration, 1
  - information, 155
  - restart, 6
  - restore, 149
  - turn off, 6
  - turn on, 6
- Phone Calls
  - Using Internet calling, 27
- Phone number
  - save to Contacts, 42
- Picture
  - view, 94
- Pinch, 10
- Play Music
  - play, 74
- Plus (+) Code Dialing, 26
- Portable Wi-Fi hotspot, 87
  - connect, 88
  - set up, 87
  - settings, 88
- Power/Lock key, 2
- Print, 154
- Programmable key, 2, 136
- Proximity sensor, 2
- Quick settings, 19
- Recent apps key, 2
- Recent calls, 33
  - clear, 34
  - filter, 34
  - view, 33
- Restore, 149
- Ringtone, 132
  - mute, 28
- Roaming
  - data roaming, 128
- Rotate, 10, 134
- Screen lock, 140
- Security
  - credential storage, 145
  - decryption, 144
  - device administrators, 145
  - encryption, 144
  - make passwords visible, 144
  - reset password, 144
  - screen lock, 140
  - settings, 143
  - unknown sources, 145
  - verify apps, 145
- Settings, 125
- Setup Wizard, 7
- SIM card
  - insert, 3
  - remove, 4
  - slot, 2
- Slide, 10
- Sound
  - lock screen, 133
  - music effects, 131
  - notification, 133
  - persistent alerts, 132
  - SD card notifications, 134
  - settings, 131
  - touch dialpad, 36, 133
  - touchscreen, 133
- Sound Recorder, 109
- Speaker, 2
- Speaker key, 2
- Speed dialing, 25
  - set up, 32
- Spread, 10
- Status bar, 17
- Status Icons, 17
- Stopwatch, 109
- Storage
  - microSD, 122
  - phone, 137
  - settings, 137
  - USB, 137
- Swipe, 10
- TalkBack, 151

- Tap, 9
- Tap & pay, 139
- Tethering, 88
  - Bluetooth, 89
  - USB, 89
- Text
  - copy and paste, 23
  - enter, 20
- Text Messaging
  - Conversations, 61
  - Draft messages, 60
  - Notifications, 61
  - Options, 63
  - Send messages, 59
- Text Messaging and MMS
  - send pictures or videos, 99
- Text-to-speech, 111
- Timer, 108
- Touch and hold, 9
- Touchscreen, 2
  - navigation, 9
  - turn off, 7
  - turn on and start, 7
- TTY mode, 37
- Update phone, 124
- USB
  - connection, 138
  - port, 2
- Vibrate
  - intensity, 131
  - pattern, 132
  - touch, 133
  - when ringing, 132
- Video, 90
  - record video, 91
  - settings, 93
  - view, 94
  - viewfinder screen, 90
- Virtual Private Networks (VPN), 79
  - add a connection, 80
  - connect or disconnect, 80
  - install security certificates, 80
  - prepare for a connection, 79
- Voice Dialer, 111
- Voice search, 112
  - settings, 148
- Voicemail, 7, 28
  - notification, 28
  - retrieve, 29
- Volume key, 2
- Volumes, 131
- Wallpaper, 14
- Widget
  - add to Home screen, 13
  - remove from the Home screen, 13
- Wi-Fi, 76
  - check status, 77
  - connect, 76, 77
  - settings, 77
  - turn on, 76
- Wireless charging, 5
- YouTube, 65
  - share videos, 99