

# KYOCERA Rise

## User Guide



© 2012 Kyocera Corporation. All rights reserved. The "Virgin" name and the Virgin signature logo are registered trademarks of Virgin Enterprises Limited and are used under license. All other trademarks are the property of their respective owners. KYOCERA is a registered trademark of Kyocera Corporation.

# Table of Contents

---

Get Started .....	1
Your Device at a Glance.....	2
Set Up Your Device .....	2
Activate Your Device .....	3
Create Your Account and Pick Your Plan.....	4
Activate Your Device.....	4
Account Management.....	4
Managing Your Account.....	4
Top-Up Your Account .....	5
Set Up Voicemail.....	5
Mobile ID .....	6
Installing an ID Pack .....	6
Switching ID Packs .....	7
Customer Support .....	7
Virgin 411 .....	7
Device Basics .....	8
Your Device's Layout.....	9
Key Functions .....	9
Turn Your Device On and Off .....	10
Turn Your Device On .....	11
Turn Your Device Off .....	11
Turn Your Screen On and Off.....	11
Turn the Screen Off When Not in Use.....	11
Turn the Screen On and Unlock It.....	11
Touchscreen Navigation .....	12
Touch.....	12
Touch and Hold.....	12
Drag.....	12
Slide or Flick .....	12
Pinch and Spread .....	13

Rotate .....	13
Your Home Screens .....	13
Home Screen Overview .....	13
Customize the Home Screens.....	14
Status Bar .....	15
Status Icons .....	16
Notification Icons.....	16
Enter Text.....	17
Slide-out QWERTY Keyboard.....	17
Touchscreen Keyboard .....	19
Enter Text Using Swype.....	19
Enter Text Using the Android Keyboard .....	24
Copy and Paste Text .....	28
Google Account.....	30
Create a Google Account.....	30
Sign In to Your Google Account .....	31
Add Account .....	31
General Sync Settings .....	32
Phone .....	33
Make Phone Calls .....	33
Call Using the Phone Dialpad .....	33
Call From Recent Calls .....	34
Call From People .....	34
Call a Number in a Text Message .....	35
Call Emergency Numbers .....	35
Call Numbers with Pauses .....	36
Call Using Plus (+) Code Dialing.....	36
Call Using the Internet Calling.....	36
Receive Phone Calls .....	37
Voicemail.....	38
Set Up Voicemail .....	38
Voicemail Notification.....	39
Retrieve Your Voicemail Messages.....	39

Voicemail Settings .....	39
Phone Call Options.....	40
Caller ID.....	40
Call Waiting.....	40
Other Call Settings.....	41
In-Call Options .....	42
Call Log .....	43
View Recent Calls.....	43
Call Log Options .....	43
Clear Call Logs .....	44
Device Settings.....	45
WIRELESS & NETWORKS Settings .....	45
Wi-Fi .....	45
Bluetooth.....	45
Data Usage.....	45
Airplane Mode.....	46
Mobile Networks .....	47
DEVICE Settings .....	48
Sound .....	48
Display .....	50
Storage .....	52
Battery .....	52
PC Connection.....	52
Apps .....	52
PERSONAL Settings.....	53
Accounts & Sync.....	53
Location Services.....	53
Security.....	54
Language & Input.....	58
Backup & Reset .....	58
SYSTEM Settings.....	59
Date & Time.....	59
Accessibility .....	60

Developer Options .....	61
About Phone .....	61
System Update .....	61
People .....	63
Get Started with People.....	63
Access People .....	63
People List Options.....	64
Add a New People Entry .....	64
Save a Phone Number .....	66
Edit a People Entry.....	66
Add or Edit Information for a People Entry .....	67
Assign a Stored Picture to a People Entry.....	67
Assign a New Picture to a People Entry.....	67
Assign a Ringtone to a People Entry.....	68
Assign a Vibration to a People Entry .....	68
Add an Entry to Favorites.....	68
Send an Entry's Call to Voicemail .....	68
Delete a People Entry .....	69
Select People List.....	69
Customize People List.....	69
Synchronize People Entries.....	69
Display Options .....	70
Share a People Entry .....	70
Messaging .....	72
Gmail.....	72
Access Gmail.....	72
Send a Gmail Message.....	73
Read and Reply to Gmail Messages .....	73
Email .....	74
Add an Email Account (POP3 or IMAP) .....	74
Add a Corporate Account.....	75
Create Another Email Account.....	76
Compose and Send Email .....	76

View and Reply to Email .....	77
Manage Your Email Inbox .....	77
Email General Settings .....	78
Email Account Settings .....	78
Delete an Email Account .....	79
Text Messaging and MMS .....	80
Compose Text Messages .....	80
Send a Multimedia Message (MMS) .....	81
Save and Resume a Draft Message .....	82
New Messages Notification .....	83
Managing Message Conversations .....	83
Text and MMS Options .....	85
Social Networking Accounts .....	86
YouTube .....	86
Google Talk .....	87
Signing In and Chatting .....	87
Managing Your Friends .....	89
Mobile Indicators .....	89
Signing Out .....	90
Google Talk Settings .....	90
Applications and Entertainment .....	92
Google Play Store App .....	92
Find and Install an Application .....	92
Create a Google Wallet Account .....	94
Request a Refund for a Paid Application .....	94
Open an Installed Application .....	94
Uninstall an Application .....	95
Get Help with Google Play .....	95
Navigation .....	95
Google Maps .....	96
Google Navigation .....	98
Google Latitude .....	98
Google Play Music App .....	101

Open the Play Music Library .....	102
Play Music .....	102
Search for Music in the Play Music Library.....	104
Use Playlists .....	104
Back Up Your Downloaded Music Files .....	105
Web and Data.....	107
Wi-Fi.....	107
Turn Wi-Fi On and Connect to a Wireless Network .....	107
Check the Wireless Network Status .....	108
Connect to a Different Wi-Fi Network .....	108
Data Services .....	109
Launch a Web Connection .....	109
Data Connection Status and Indicators .....	109
Browser .....	110
Learn to Navigate the Browser.....	110
Browser Menu.....	111
Select Text on a Web Page .....	112
Adjust Browser Settings .....	113
Adjust Browser Privacy and Security Settings.....	113
Adjust Browser Accessibility Settings.....	114
Adjust Browser Advanced Settings .....	115
Adjust Browser Bandwidth Management Settings .....	116
Adjust Browser Labs Settings .....	116
Set Search Engine .....	116
Create Website Settings .....	116
Reset the Browser to Default .....	117
Set the Browser Home Page.....	117
Read Web Page Offline .....	117
Manage Bookmarks .....	117
Camera and Video .....	119
Take Pictures .....	119
Open the Camera .....	119
Camera Viewfinder Screen .....	120

Review Screen.....	121
Take a Picture.....	121
Close the Camera .....	122
Record Videos.....	122
Video Viewfinder Screen.....	122
Record a Video .....	123
Camera/Video Settings.....	124
View Pictures and Videos Using Gallery.....	125
Open Gallery.....	125
View Photos and Videos .....	126
Zoom In or Out on a Photo.....	126
Watch a Video .....	127
Close Gallery .....	127
Working with Photos.....	127
Photo Options Menu .....	127
Edit a Photo .....	128
Rotate and Save a Photo .....	128
Crop a Photo.....	129
Share Photos and Videos.....	129
Send Photos or Videos by Email/Gmail.....	130
Send Photos or Videos by Multimedia Message .....	130
Send Photos or Videos Using Bluetooth .....	130
Share Photos or Videos on Google+.....	131
Share Photos on Picasa.....	131
Share Videos on YouTube .....	132
Tools and Calendar.....	133
Calendar.....	133
Add an Event to the Calendar .....	133
Invite Guests to Your Event.....	134
Event Alerts .....	135
View Events .....	136
Erase Events .....	137
Show or Hide Calendars .....	138



Synchronize Calendars with Your Device.....	138
Clock & Alarm.....	138
Open Clock.....	138
Set an Alarm.....	139
Change Alarm Settings.....	140
Calculator.....	141
Voice Service.....	141
Automatic Speech Recognition (ASR).....	141
Text-to-speech Settings.....	142
Voice Search.....	142
Eco Mode.....	143
Bluetooth.....	145
Turn Bluetooth On or Off.....	145
The Bluetooth Menu.....	145
Connect a Bluetooth Headset or Car Kit.....	146
Reconnect a Headset or Car Kit.....	147
Disconnect or Unpair From a Bluetooth Device.....	147
Disconnect a Bluetooth Device.....	147
Unpair From a Bluetooth Device.....	147
Send and Receive Information Using Bluetooth.....	148
Send Information From Your Device to Another Device.....	148
Receive Information From Another Device.....	149
microSD Card.....	151
Remove the microSD Card.....	151
Insert a microSD Card.....	152
View the microSD Card Memory.....	152
Format the microSD Card.....	152
Unmount the microSD Card.....	153
Use the Device's microSD Card as a USB Drive.....	153
Use the Device's microSD Card as a Media Device.....	154
Notes.....	155
Copyrights.....	156
Index.....	157

# *Get Started*

---

This section gives you all the information you need to set up your device and the service the first time.

[Your Device at a Glance](#)

[Set Up Your Device](#)

[Activate Your Device](#)

[Account Management](#)

[Set Up Voicemail](#)

[Mobile ID](#)

[Customer Support](#)

[Virgin 411](#)

## Your Device at a Glance



## Set Up Your Device

You must first install and charge the battery to begin setting up your device.

1. Install the battery.
  - Hook your thumb- or fingernail into the slot at the left side of the battery compartment cover (①) and gently lift up to remove the cover (②).

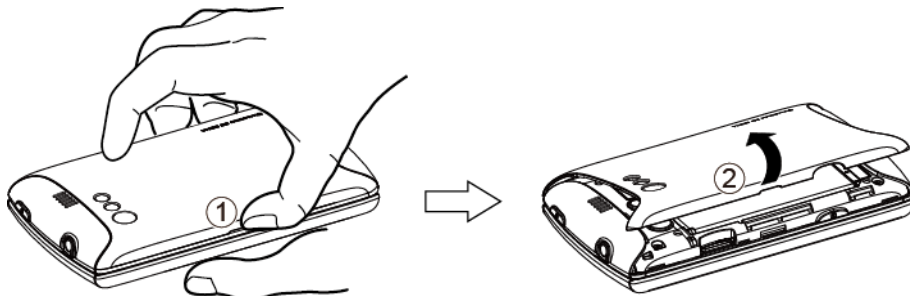

- Insert the battery, contacts end first, and gently press into place (3).

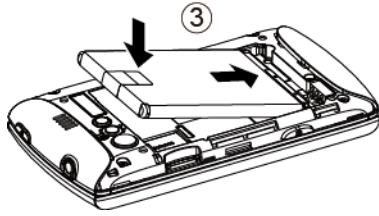

- Make sure the locking tabs of the cover are seated and then gently press the cover. (4).

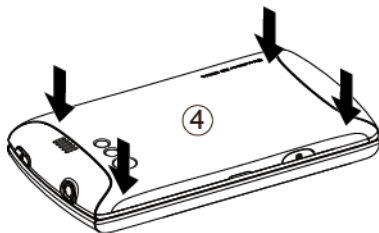

## 2. Charge your battery.

- Plug the smaller end of the micro-USB cable into the device's charger/accessory jack.

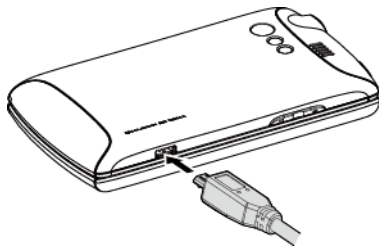

- Plug the other end of the USB cable into the charger, and then plug the charger into an electrical outlet.

**WARNING:** Do not handle a damaged or leaking Li-Ion battery as you can be burned.

**Note:** Your device's battery should have enough charge for the device to turn on and find a signal, run the setup application, set up voicemail, and make a call. You should fully charge the battery as soon as possible.

## 3. Press and hold the **Power** button to turn your device on.

To remove the battery, after removing the battery compartment cover, grasp the tab extending from the battery pack and pull the battery out of its compartment.

## *Activate Your Device*

Find out information about activating your device.



## Create Your Account and Pick Your Plan

### Activate Your Device

## Create Your Account and Pick Your Plan

1. From your computer, visit [virginmobileusa.com](http://virginmobileusa.com) and click on **Activate**.
2. Choose an activation option and click **Next**. Then enter your zip code and click **Next**.
3. When prompted, enter the serial number (MEID DEC) printed on the sticker located on the back of your device in the battery compartment and click **Next**.
4. Follow the remaining instructions to choose your plan and select a payment method.
5. Follow the activation instructions below after creating your account in order to be able to start using your device.

## Activate Your Device

1. Turn on your new device.
2. Touch the Activate icon  on the home screen.  
– or –  
Touch  , and then touch the Activate icon .
3. Follow the onscreen prompts to complete the activation process.

After activation, your device will automatically download “The Essentials” ID pack. This may take several minutes or more depending on the network speed. However, you may continue to use your device as the ID pack is being downloaded in the background.

## Account Management

Find out information about managing your account.



### Managing Your Account

### Top-Up Your Account

## Managing Your Account

Manage your account from your device or your computer.

### From Your Device

Dial \*86 on your device or press **Home**  and touch  > **My Account**  to access your Account, where you can do any of the following things:

- Check your minutes
- Add money (Top-Up)
- Change plans... and a lot more

## From Your Computer

Log in with your phone number and Account PIN at [virginmobileusa.com](http://virginmobileusa.com) where you can do everything above, and more.

## Top-Up Your Account

Buy Top-Up cards at thousands of retailers. Or, make it real easy by registering your credit/debit card or PayPal account.

## Auto Top-Up

Auto Top-Up is the easiest way to keep your service working. Set it to Top-Up your account once a month so you can keep emailing, IMing, Tweeting with Twitter, surfing, and talking. No interruptions, no sweat. Activate Auto Top-Up and adjust your settings anytime by logging at [virginmobileusa.com](http://virginmobileusa.com).

## One-time Top-Ups

From Your Device:





Dial \*729 on your device or press **Home**  and touch  > **My Account** .

From Your Computer:

If you don't want to set Auto Top-Up, you can still log in at [virginmobileusa.com](http://virginmobileusa.com) whenever you need a quick Top-Up.

## Set Up Voicemail

You should set up your voicemail and personal greeting as soon as your device is activated. Always use a password to protect against unauthorized access. Your device automatically transfers all unanswered calls to your voicemail, even if your device is in use or turned off.

1. Press **Home** , and touch . (If your screen is locked, press the **Power** button to turn on the display, and then touch  and flick it to unlock the screen.)
2. Touch and hold  to dial your voicemail number.
3. Follow the system prompts to:
  - Create your password.

- Record your name announcement.
- Record your greeting.

**Note: Voicemail Password** – It is strongly recommended that you create a password when setting up your voicemail to protect against unauthorized access. Without a password, anyone who has access to your device is able to access your voicemail messages.

## Mobile ID

Mobile ID is a free service from Virgin Mobile that lets you download a complete mobile experience on demand. Customize your device to match whatever you're into... music, entertainment, social networking, and more.

“The Essentials” ID pack includes an entire set of apps, widgets, and more – handpicked by Virgin Mobile.



You can install as many as five ID Packs at any one time in addition to the default “The Essentials” ID pack. You can easily switch from one ID Pack to another without losing any applications already installed.

### Installing an ID Pack



#### Switching ID Packs

### Installing an ID Pack

**Note:** Your device must be activated, your battery should be fully charged, and you should be in a network coverage area before you install an ID Pack.

1. Press **Home** , and touch . (If your screen is locked, press the **Power** button to turn on the display, and then touch  and flick it to unlock the screen.)
2. Touch **Get New ID Packs**.
3. Touch **All ID Packs**.
4. Scroll to and touch the desired ID Pack.
5. Touch **Install**.
6. Read the Terms and Conditions and touch **Agree**.
  - If a **Downloading** message appears, read the message and touch **Continue**.
7. The ID Pack is now installed.

## Switching ID Packs

1. Press **Home** , and touch .
2. Touch an ID Pack to replace your current pack.

– or –

Touch **Get New ID Packs** to install a new ID Pack and follow steps 3–7 of [Installing an ID Pack](#).

**Note:** Certain features of Mobile ID are subject to change. For the most up-to-date information about using Mobile ID, please visit [virginmobileusa.com](http://virginmobileusa.com).

## Customer Support

Contact Virgin Mobile's customer support department for information about your device, account history, call coverage area, and specific features available to you.

- Visit [virginmobileusa.com](http://virginmobileusa.com).
- Dial \*VM from your Virgin Mobile device.
- Dial 1-888-322-1122 from any phone.

For questions about the device features, refer to the materials provided with your device, or visit [virginmobileusa.com](http://virginmobileusa.com).

## Virgin 411

Virgin 411 gives you access to a variety of services and information, including residential, business, and government listings; movie listings or show times; driving directions, restaurant reservations, and major local event information. There is a per-call charge to use Virgin 411, and you will be billed for airtime.

- Dial 411 from your Virgin Mobile device.

For more information or to see the latest in services, visit [virginmobileusa.com](http://virginmobileusa.com).



# *Device Basics*

---

The topics in this section will introduce the basic functions and features of your device.

[Your Device's Layout](#)

[Turn Your Device On and Off](#)

[Turn Your Screen On and Off](#)

[Touchscreen Navigation](#)

[Your Home Screens](#)

[Status Bar](#)

[Enter Text](#)

[Google Account](#)

## Your Device's Layout

The illustrations and descriptions below outline your device's basic layout.







### Key Functions

- **Power Button** lets you turn the device on or off, or turn the screen backlight on or off. This button can be configured to end a call.
- **LED Indicator** shows your device's battery status. It also flashes for incoming calls or pending notifications.
- **Proximity Sensor/Light Sensor** automatically deactivates the touchscreen when you hold the device near your face. This prevents you from unintentionally activating device functions during a call. It also automatically turns off the backlight and brightens the display when you are in sunlight or a bright room, and dims the display in darker places.
- **Volume Button** allows you to adjust the ringtone and media volumes when you are not on a call, or the voice volume during a call.

- **Charger/Accessory Jack** allows you to connect the micro-USB cable (included) to charge the battery or to transfer files to and from a computer.

**CAUTION!** Inserting an accessory into the incorrect jack may damage the device.

- **Back Key** () returns you to the previous screen or closes the dialog box.
- **Home Key** () returns you to the Home screen.
- **Recent Apps Key** () allows you to show the Recent Apps screen.
- **Menu Key** () lets you open the menus of the current screen or application.
- **Camera Button** lets you activate the camera and camcorder and take pictures and videos.
- **Display Screen** displays all the information needed to operate your device. Use finger gestures to navigate and interact with items on the screen.
- **microSD Card Slot** (internal) allows you to insert a microSD card to support external memory.

**Note:** Your device comes with the microSD card preinstalled.

- **Earpiece** lets you hear the caller and automated prompts.
- **Headphone Jack** allows you to plug in an optional headset for convenient, hands-free conversations.

**CAUTION!** Inserting an accessory into the incorrect jack may damage the device.

- **Internal Antennas** facilitate reception and transmission. To maximize performance, do not obstruct while using the device.
- **Microphone** allows other callers to hear you clearly when you are speaking to them.
- **Camera Lens**, as part of the built-in camera, lets you take pictures and videos.
- **Camera Flash** allows you to take pictures and videos in low light conditions.
- **Self Portrait Mirror** allows you to see your reflection when taking photos or videos.
- **Speaker** lets you hear the different ringtones and sounds. It also lets you hear the caller's voice in speakerphone mode.

## *Turn Your Device On and Off*

The instructions below explain how to turn your device on and off.

### Turn Your Device On

## Turn Your Device Off

### *Turn Your Device On*

To turn your device on, follow the step below.

- ▶ Press and hold the **Power** button.

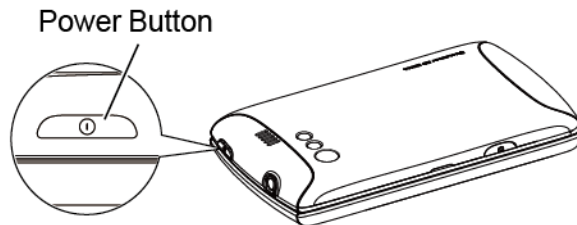

### *Turn Your Device Off*

To turn your device off, follow the steps below.

- ▶ Press and hold the **Power** button to open the device options menu. Touch **Power off** > **OK** to turn the device off.

Your screen remains blank while your device is off.

### *Turn Your Screen On and Off*

Your device allows you to quickly turn the screen off when not in use and to turn it back on and unlock it when you need it.

#### Turn the Screen Off When Not in Use

#### Turn the Screen On and Unlock It

### *Turn the Screen Off When Not in Use*

To turn your screen off, follow the step below.

- ▶ To quickly turn the screen off, press the **Power** button. Pressing the **Power** button again will turn on your device screen and show the lock screen.

To save battery power, the device automatically turns off the screen after a certain period of time when you leave it idle. You will still be able to receive messages and calls while the device's screen is off.

**Note:** For information on how to adjust the time before the screen turns off, see **Sleep** within the [Display](#) section.

### *Turn the Screen On and Unlock It*

1. To turn the screen on, press the **Power** button.

2. Flick  until it turns to  (with a blue frame) to unlock the screen.

– or –

Open the slide-out QWERTY keyboard.

- You can disable the screen lock or add more secure one from the System settings menu. See **Screen lock** within the [Security](#) section.

## *Touchscreen Navigation*

Your device's touchscreen lets you control actions through a variety of touch gestures.

Touch

Touch and Hold

Drag

Slide or Flick

Pinch and Spread

Rotate

### *Touch*

Touch once with your finger to select or launch a menu, option, or application. A light touch works best.

**Warning:** Do not touch with a pen or stylus. It may damage the touchscreen.

**Warning:** If the touchscreen of your device does get wet, dry it with a clean soft cloth before touching it.

### *Touch and Hold*

To open the available options for an item (for example, options for a contact), simply touch and hold the item.

### *Drag*

Touch and hold your finger before you start to move it. Do not release your finger until you have reached the target position.

### *Slide or Flick*

To slide, quickly move your finger vertically or horizontally across the screen. To flick, move your finger in lighter, quicker strokes than sliding. When you're flicking through a long list, touch the screen to stop scrolling.

## Pinch and Spread

Pinch the screen using your thumb and forefinger to zoom out or spread the screen to zoom in when viewing a picture or a Web page. (Move fingers inward to zoom out and outward to zoom in.)

## Rotate

For most screens, you can automatically change the screen orientation from portrait to landscape by turning the device sideways. When entering text, you can turn the device sideways to bring up a bigger keyboard. See [Touchscreen Keyboard](#) for more details.

**Note:** The **Auto-rotate screen** check box in **Home**  > **Menu**  > **System settings** > **Display** needs to be selected for the screen orientation to automatically change.

## Your Home Screens

The Home screen is the starting point for your device's applications, functions, and menus. You can customize your home screen by adding shortcuts, widgets, and more. Your home screen extends beyond the initial screen. Swipe the screen left or right to display additional screens.

### Home Screen Overview

### Customize the Home Screens

## Home Screen Overview

The below explains some examples you see on the Home screen.



1. **Status Bar:** Displays the time, notification, and device status icons. Slide down to display the Notifications panel.
2. **Shortcut:** Allows users to quickly launch applications.
3. **Application Launcher:** Touch to display available applications and widgets on the device.
4. **Favorites Tray:** Keeps icons of your favorite application. The icons in the tray remain visible on every Home screen. You can change icons except the Application launcher icon (center).
5. **Screen Position Indicator:** Allows users to know where you are among five home screens.
6. **Folder:** Allows users to store multiple application icons as a group.
7. **Google Search Bar:** Allows users to enter text or spoken keywords for a quick search on the device or on the Internet. Touch to enter text or touch  to speak your keyword.

## *Customize the Home Screens*

Learn how to add, move, or remove items from the home screen.

### Add Application Icons or Widget to the Home Screens

1. Touch  on the Favorites Tray.
2. Slide the **APPS** and **WIDGETS** screens to find the item you want to add to the Home screens.
3. Touch and hold an application or widget icon. The initial Home screen appears.
4. Pressing the application or widget icon, move your finger left or right to the place you want to add the icon.
5. Release your finger.

### Move or Remove Items on the Home Screens

- ▶ Touch and hold the item you want to move or remove from the screen.
  - To move the item, drag it to a new area and release it.
  - To remove the item, touch and hold the item until you see “X Remove” at the top of the home screen, and then drag the item until it turns red, and then release your finger.

## Change Wallpaper

1. Touch and hold the empty area of the Home screens.
2. Select one of the following options.
  - **Gallery:** Select to use saved or captured pictures on your device. Touch to select a picture, and crop it before setting it as wallpaper.
  - **ID wallpapers:** Select to use ID wallpapers. Select the wallpaper and touch **Set wallpaper**.
  - **Live Wallpapers:** Select to use Live wallpapers. Select the wallpaper and touch **Set wallpaper**.
  - **Wallpapers:** Select to use preset wallpapers. Select the wallpaper and touch **Set wallpaper**.

## Favorites Tray

Favorites Tray keeps five icons you usually use. The icons in the tray remain visible on every Home screen. You can change icons except the Application launcher icon located in the center of the tray.

To add a new icon on the Favorites Tray:

1. Remove the current icon on the tray. See [Move or Remove Items on the Home Screens](#).
2. Touch and hold the application icon and drag it to the Favorites Tray.
3. Release your finger.

## Use folders

You can combine several app icons in a folder. Drop one app icon over another on a Home screen, and the two icons will be combined.

1. Drag one application icon over another icon.
2. Release your finger. You can see two icons piled within a folder (a black circle).
3. Touch a circle. You can see application icons within the folder.
4. Touch **Unnamed Folder**. The keyboard opens and you can name this folder. To rename it, touch the name.

## Status Bar

The status bar at the top of the screen provides device and service status information on the right side and notification alerts on the left. To view notification alerts, slide the status bar down.















## Status Icons

## Notification Icons





### Status Icons









Icon	Description
	Bluetooth® enabled
	Wi-Fi® active (full signal)
	Vibrate
	Silent
	Network (full signal)
	Network (no signal)
	3G (data service)
	Airplane mode
	Alarm set
	Battery (charging)
	Battery (full charge)
	Battery (discharged)

### Notification Icons



Icon	Description
	Missed call
	New email
	New Gmail
	New SMS message

	New MMS message
	Event
	Music application is running background
	USB connection
	Alarm
	When animating, GPS is active
	Downloading

## *Enter Text*

You can type on your device using either the slide-out QWERTY keyboard or one of the available touchscreen keyboards.

[Slide-out QWERTY Keyboard](#)

[Touchscreen Keyboard](#)

[Enter Text Using Swype](#)

[Enter Text Using the Android Keyboard](#)

[Copy and Paste Text](#)

## *Slide-out QWERTY Keyboard*

Open the slide-out QWERTY keyboard to type faster using your thumbs. The slide-out keyboard also comes with special keys that let you quickly access menus and search your device.

To open the slide-out QWERTY keyboard:

1. Hold the phone sideways, with the front panel buttons to your right.
2. Push the screen panel up with your thumbs to reveal the slide-out keyboard.

**Note:** When the slide-out keyboard is opened, the display stays in landscape mode and you will not be able to use the onscreen keyboard.



3. Start an app or select a field that requires text or number entry.
4. Press the letter keys to enter text. Press the following keys to enter uppercase letters, numbers, special characters, or symbols:

- **Shift key** (⇧)

- Press once to capitalize the next letter you select.
- Press twice to lock the shift key and type a series of uppercase letters. (This works just like the Caps Lock key on your computer keyboard.)
- To unlock, press the shift key once again.

- **Function key** (fn)







- Press to enter the number or symbol located at the upper right corner of the key (for example #, \*, &, +, !, .com). Press this key first and then any corresponding key.
- Press twice to lock the function key.
- To unlock, press the function key once again.

**Note:** Do not confuse with the four keys at the bottom of your device when closed and in portrait orientation. These keys can also be referred to as “function keys.”

- **Symbol key** (sym)

- Press to open the Symbols window. Touch the symbol you want to insert into your text.

5. Press these keys to perform other actions:



- **Navigation keys** (   )
  - Press to scroll through the phone's menu options. On the text input screen, press to move the cursor.
- **Enter key** ()
  - Press to insert a line feed in text input mode, or access the phone's menus and select the highlighted choice when navigating through a menu.
- **Backspace key** ()
  - Press to delete characters from the display in text input mode.

## *Touchscreen Keyboard*

The touchscreen keyboard lets you enter text directly onscreen without opening the slide-out QWERTY keyboard.

Your device provides convenient ways to enter letters, numbers, and symbols whenever you are prompted to enter text. To manually display the touchscreen keyboard, simply touch a text field where you want to enter text. There are two ways of entering text on your device: **Swype** and **Android keyboard**.

To switch the touchscreen keyboard:

1. Press **Home**  > **Menu** , and touch **System settings** > **Language & input**.
2. Touch **Default** under **KEYBOARD & INPUT METHODS**.
3. Choose **Android keyboard** or **Swype**.

– or –

1. When a touchscreen keyboard is displayed, slide the status bar down.
2. Touch **Select input method**.
3. Choose **Android keyboard** or **Swype**.

## *Enter Text Using Swype*

Swype® allows you to enter text by sliding your finger from letter to letter rather than touching each key individually. To enter text, slide your finger from one letter to the next.

## Swype Keyboard Overview

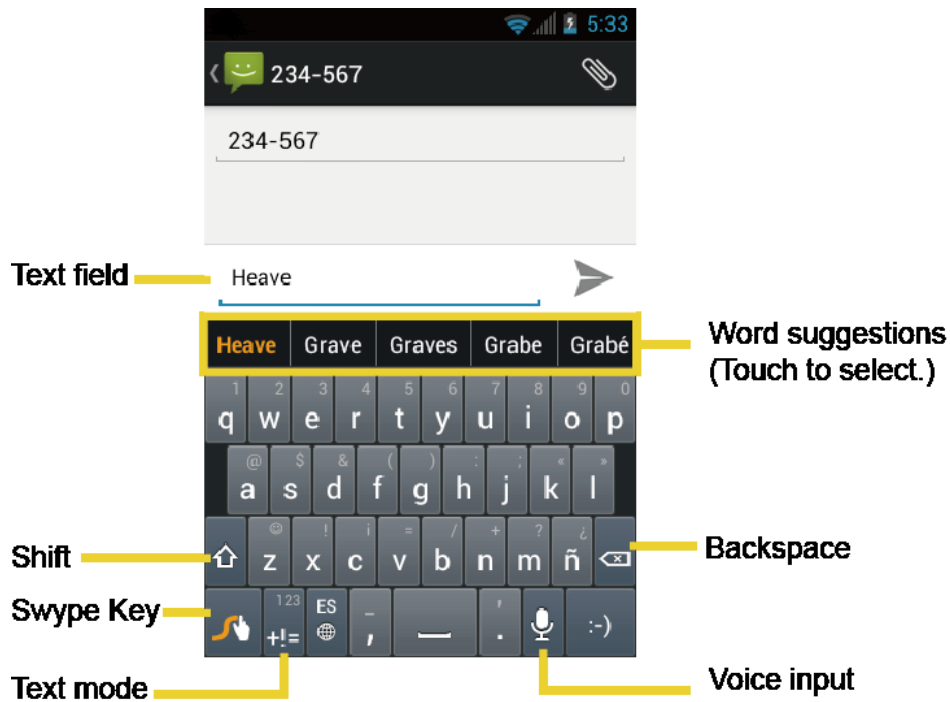

**Note:** Key appearance may vary depending on the selected application.



**Example: dog**  
Place your finger on the key with the first letter of the word and glide to the following letters. Lift your finger after the last letter.











**Example: cool**  
For double letters, circle the letter.



Example: You  
To capitalize the letter, slide  
up over the keyboard.

**Tip:** For tips on using Swype, touch and hold the Swype key  and then select **How to Swype**.



You can do the following with the Swype keyboard:

	<b>Text mode:</b> Touch to toggle between the Alphabet keyboard and Number & Symbol keyboard.
	<b>Swype Key:</b> Touch and hold to access the tips or the settings of Swype.
	<b>Voice input mode:</b> Touch to enter text using your voice.
	<b>Backspace:</b> Touch to delete a character. Touch and hold to delete multiple characters.
	<b>Smiley:</b> Touch to insert a smiley. Touch and hold to view and select other smileys.
	<b>Space:</b> Touch to insert a space.
	<b>Enter:</b> Touch to confirm your entry.
	<b>Shift:</b> Touch to toggle between the uppercase, lowercase and caps lock text input.

For more information about the Swype application, visit [www.nuancemobilelife.com/apps/swype](http://www.nuancemobilelife.com/apps/swype).

## ABC Mode

In ABC mode, you can enter letters from the onscreen keyboard by sliding your finger. While in this mode, the text mode key displays .



1. Select the ABC mode by touching . Capitalization in ABC mode can be altered by touching .

 (Unshifted) to make all letters in a word lowercase.

 (One-character-shifted) to capitalize only the first letter of a word.

 (Caps Lock) to make all letters in a word uppercase.



2. Enter text using the keyboard.

- If you make a mistake, touch  to erase a single character. Touch and hold  to erase an entire word.
- Touch the key for the characters you want to enter.
- Touch and hold to enter the character located at the upper right corner of the key. Confirm the character you want to enter is displayed and release your finger.
- Touch and long-hold to bring up a list of all the characters available on that key. Touch the character you want to enter from the list.

## Numbers & Symbol Mode

In Number & Symbol mode, you can enter numbers and symbols from the onscreen keyboard by sliding your finger. While in this mode, the text mode key displays .

To enter numbers and symbols in Swype mode:

1. Select the Number & Symbol mode by touching .
2. Enter numbers or symbols using the keyboard.
  - If you make a mistake, touch  to erase a single character. Touch and hold  to erase an entire word.
  - Touch the key for the number or symbol you want to enter.
  - Touch and hold to enter the number or symbol located at the upper right corner of the key. Confirm the number or symbol you want to enter is displayed and release your finger.
  - Touch and long-hold to bring up a list of all the characters available on that key. Touch the character you want to enter from the list.

**Tip:** Touch  to show the keyboard with the symbol characters located at the upper right corner of the key.









## Entering Text by Speaking

You can use voice input to enter text by speaking anywhere that you can enter text with the touchscreen keyboard.

1. Touch  on the keyboard.
2. Say the text you wish to enter into the microphone.



## Adding a Word to the User Dictionary

You can use the user dictionary option to add new words into the dictionary.

1. Press **Home**  > **Menu** , and touch **System settings** > **Language & input**.
2. Scroll to **Swype** under **KEYBOARD & INPUT METHODS** and touch .
3. Touch **Personal dictionary**.
4. Touch  and type the word you want to add, and then touch . (A list of words you have added to the dictionary is displayed.)
  - To edit a word, touch a word to edit it.
  - To delete a word, touch  and touch a word to check it and then touch  > **OK**.
    - Touch  to select all the words in the dictionary.
    - Touch  to cancel deleting and back to the previous screen.

## Swype Settings

You can customize the Swype settings as you like.

1. Press **Home**  > **Menu** , and touch **System settings** > **Language & input**.
2. Scroll to **Swype** under **KEYBOARD & INPUT METHODS** and touch .

**Tip:** You can open the Swype settings from the Swype keyboard. Touch and hold  on the keyboard.

3. Choose from the following options.
  - **Select Input Method:** Touch to select Swype or Android keyboard.





- **How to Swype:** Touch to learn Swype in quick steps.
- **Personal dictionary:** Touch to make your personal dictionary for Swype.
- **Preferences:** Touch to show the following settings menu for Swype.
  - **Audio feedback:** Touch to turn on sounds from Swype.
  - **Vibrate on keypress:** Check to activate vibration when a key is touched.
  - **Show tips:** Check to turn on a flashing indicator for quick help.
  - **Auto-spacing:** Check to automatically insert spaces between words.
  - **Auto-capitalization:** Check to automatically capitalize the first letter of sentence-initial words within the specific text entry fields.
  - **Show complete trace:** Check to display the complete Swype path.
  - **Word suggestion:** Touch to activate word prediction when typing in Swype.
  - **Speed vs. accuracy:** Touch to set how quickly Swype responds to input.
  - **Reset Swype's dictionary:** Touch to delete all the words you have added to Swype's dictionary.
  - **Version:** Displays the current Swype version.
- **Language Options:** Touch to select the language to use on Swype.

## *Enter Text Using the Android Keyboard*

When entering text, you can choose to use the Android keyboard.

To select the Android keyboard:

1. Press **Home**  > **Menu** , and touch **System settings** > **Language & input**.
2. Touch **Default** under **KEYBOARD & INPUT METHODS**.
3. Touch **Android keyboard**.







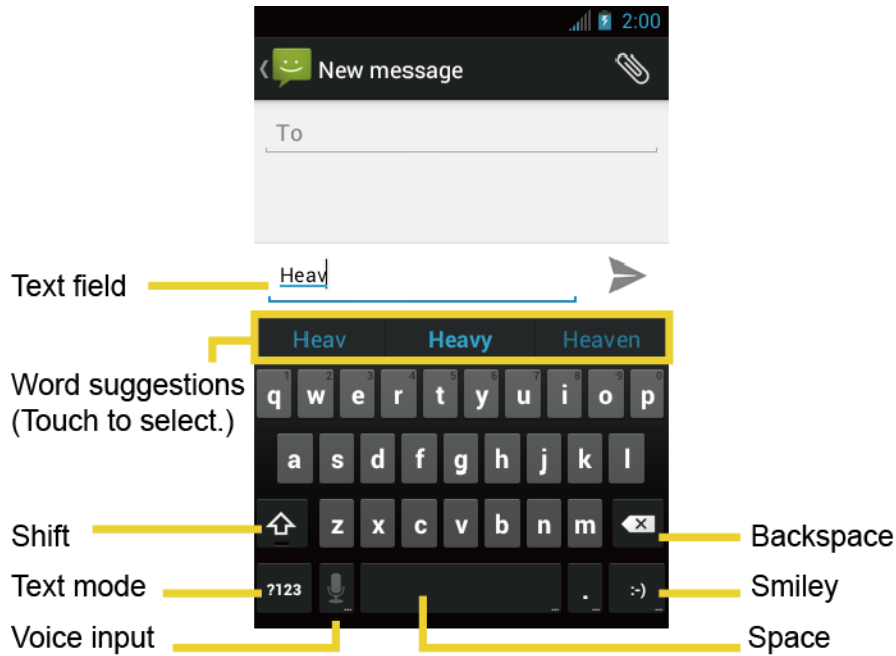



– or –

1. When a touchscreen keyboard is displayed, slide the status bar down.
2. Touch **Select input method**.
3. Touch **Android keyboard**.

## Android Keyboard Overview



You can do the following with the Android keyboard:

 	<b>Shift:</b> Touch to toggle between lower case or upper case.
	<b>Capslock:</b> Double-touch the lower case or upper case shift key.
 	<b>Text mode:</b> Touch to toggle between the Alphabet keyboard and Number & Symbol keyboard.
	<b>Smiley:</b> Touch to insert a smiley. Touch and hold to view and select other smileys.
	<b>Next:</b> Touch to go to the next text entry field.
 	<b>Alternate:</b> Touch to toggle between the default Number & Symbol keyboard and additional Number & Symbol keyboard.
	<b>Go:</b> Touch to go to a Web address.
	<b>Space:</b> Touch to insert a space. Touch and hold to select the input method.

## ABC Mode



In ABC mode, you can enter letters from the onscreen keyboard. While in this mode, the text mode key displays .

1. Select the ABC mode by touching .

- You can switch the capitalization style in ABC mode by touching the shift key .

 (Unshifted) to make all letters in a word lowercase.

 (One-character-shifted) to capitalize only the first letter of a word.

- You can select the caps lock by double-touching  or  to make all letters in a word uppercase.

 (Caps Lock) to make all letters in a word uppercase.

2. Touch the corresponding alphabet keys to enter the word.

**Tip:** Some keys have alternate characters. Touch and hold a key to bring up a list of all the characters available on that key. Touch the character you want to enter from the list.

## Numbers and Symbols Mode

In Number & Symbol mode, you can enter numbers and symbols only from the onscreen keyboard. While in this mode, the text mode key displays .

To enter numbers:

1. Select the Number & Symbol mode by touching .

2. Touch the appropriate numeric key.

To enter symbols:

1. Select the Number & Symbol mode by touching .

2. Touch the appropriate symbol key.

– or –

Touch  to select from additional symbol characters.



**Tip:** Some keys have alternate characters. Touch and hold a key to bring up a list of all the characters available on that key. Touch the character you want to enter from the list.

## Entering Text by Speaking

Voice input is an experimental feature that uses Google's speech-recognition service, so you must have a data or Wi-Fi connection to use it.

If the touchscreen keyboard does not display , voice input is not turned on.

To turn on voice input:





1. Press **Home**  > **Menu** , and touch **System settings** > **Language & input**.
2. Scroll to **Android keyboard** under **KEYBOARD & INPUT METHODS** and touch .
3. Touch **Voice input key** and select **On main keyboard** or **On symbols keyboard**.

To enter text by speaking:



1. Touch  on the keyboard.
2. Say the text you wish to enter into the microphone and touch **Done**.

## Adding a Word to the User Dictionary

You can use the user dictionary option to add new words into the dictionary.

1. Press **Home**  > **Menu** , and touch **System settings** > **Language & input** > **Personal dictionary**.
2. Touch .
3. Type the word you want to add, and touch **OK**. (A list of words you have added to the dictionary is displayed.)
  - Touch a word to edit it.
  - Touch  to delete it.

## Android Keyboard Settings

1. Press **Home**  > **Menu** , and touch **System settings** > **Language & input**.
2. Scroll to **Android keyboard** under **KEYBOARD & INPUT METHODS** and touch .

**Tip:** Check **Show settings key** to always show  on the Android keyboard.

**Tip:** If  is not displayed, touch and hold the key at the left of the space key and then touch **Android keyboard settings**.

3. Choose from the following options:

- **Input languages:** Touch to select the input language. The dictionary for the selected language will be enabled.
- **Auto-capitalization:** Check to automatically set the first letter of a sentence to upper case.
- **Vibrate on keypress:** Check to activate vibration when a key is touched.
- **Sound on keypress:** Check to activate a clicking sound when a key is touched.
- **Popup on keypress:** Check to display a larger image of the key above it when you touch it.
- **Show settings key:** Check to display the keyboard settings key on the keyboard.
- **Voice input key:** Touch to select where the Voice Input key is displayed from **On main keyboard**, **On symbols keyboard**, or **Off**.
- **Add-on dictionaries:** Touch to select the dictionary you want to use.
- **Auto correction:** Touch to allow the space bar and punctuation to automatically correct mistyped words.
- **Show correction suggestions:** Touch to select when correction suggestions are displayed.
- **Advanced settings:** Touch to open the settings for expert users.

## *Copy and Paste Text*



In applications that require text entry, such as Messaging, use the copy and paste functions to copy and paste text from one application to another.

To copy and paste the text:

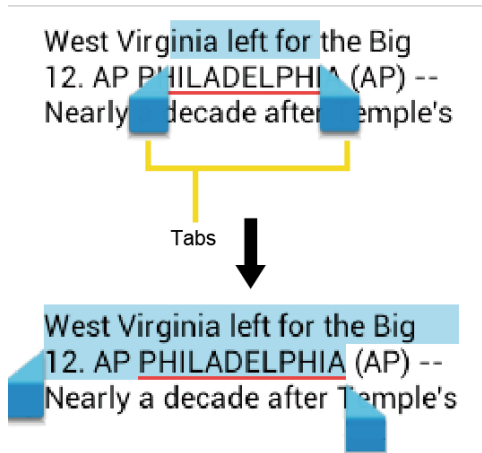
1. Open the application or received message that you want to copy text from.
2. Touch and hold the text body. Selection tabs appear, and currently selected words or characters are highlighted. Drag tabs to expand or reduce the range of selected text.



**Tip:** Touch , , or **SELECT ALL** to select all the text on the Web page.

3. Touch  or  to copy.
4. Open the application that you want to paste the text to.
5. Touch and hold the text box where you want to paste the text.
6. If you want to add the selected text to the current text, drag a selection tab to the position where you want to insert selected words or characters.
7. Touch and hold the text box, and touch **PASTE**.

To copy text from a Web page:

1. Scroll to the area of the Web page containing the text you want to select.
2. Touch and hold the text you want to copy. Drag tabs to expand or reduce the range of selected text. Any selected text will appear highlighted.

**Tip:** Touch **SELECT ALL** to select all the text on the Web page.

3. Touch  > **Copy**.
4. Open the application that you want to paste into.
5. Touch and hold the text box where you want to paste the text, and touch **PASTE**.

To copy a URL:

1. To copy a URL, touch and hold the URL to display the options menu.
2. Touch **Copy link URL** or .

3. Open the application that you want to paste into.
4. Touch and hold the text box where you want to paste the URL, and touch **PASTE**.

## Google Account

You will need a Google account to access several device features such as Gmail™, Google Maps Navigation™, Google Talk™, and Google Play™ applications. Before you can access Google applications, you must enter your account information. These applications sync between your device and your online Google account.

[Create a Google Account](#)

[Sign In to Your Google Account](#)

[Add Account](#)

[General Sync Settings](#)

## Create a Google Account



If you do not already have a Google account, you can create one online or by using your device.

**Note:** Although you need a Gmail account to use certain features of your device, such as Google Play™, you do not need to use Gmail as the default account for your device.

### Create a Google Account Online

1. From a computer, launch a Web browser and navigate to [google.com](http://google.com).
2. On the main page, click **Sign in > Create an account for free**.
3. Follow the onscreen prompts to create your free account.

### Create a Google Account Using Your Device



1. Press **Home**  > **Menu** , and touch **System settings > Accounts & sync**.
2. Touch **ADD ACCOUNT**, and then touch **Google**.
3. Touch **New**.
4. Enter your First name, Last name, and touch **Next**.
5. Enter your email address and touch **Next**.
6. When prompted, enter and reenter a password and touch **Next**.
7. Create a security question and answer, enter a secondary email address to help you recover your password if you ever lose it, and then touch **Next**.

**Note:** When setting up a new Google account, either on your device or online, you will be prompted to add a secondary email address. Enter a second Gmail address or any other email address from which you currently send and receive email. This address is used to authenticate your account should you ever encounter problems or forget your password. It is strongly encouraged for Android users so you can regain access to Google services and purchases on your device.

8. Select if you want to join Google+ or not.
9. Read and accept the Google Terms of Service, and then touch **I accept**.
10. Enter the characters shown, and then touch **Next**.
11. Select if you save your credit card number or not.
12. Select if you want to set a PIN code in Google Play or not.
13. Select items you want to sync with Google servers and touch **Next**.



## *Sign In to Your Google Account*

If you already have a Google account, sign in with the account.

1. Press **Home**  > **Menu** , and touch **System settings > Accounts & sync**.
2. Touch **ADD ACCOUNT**, and then touch **Google**.
3. Touch **Existing**.
4. Enter your Gmail username and password, and then touch **Sign in**.
5. Select if you want to join Google+ or not.
6. Select if you want to set a PIN code in Google Play if requested.
7. Select items you want to sync with Google servers and touch **Next**.

## *Add Account*

You can add additional accounts to your device.

1. Press **Home**  > **Menu** , and touch **System settings > Accounts & sync**.
2. Touch **ADD ACCOUNT**.
3. Touch an account type.
  - Corporate, Google, etc.
4. Follow the instructions on the screen to add your additional account.







- Depending on the account type, you may need to enter an email address or user address, password, domain name, or other information. For Corporate accounts, contact your server administrator to determine what information you will need.

## General Sync Settings

Let applications synchronize data in the background, whether or not you are actively working in them.

As default your Google accounts are automatically synced.

1. Press **Home**  > **Menu** , and touch **System settings > Accounts & sync**.
2. If you see  at the upper right corner, your accounts will automatically sync. Touch the account with data you want to sync.
3. Touch the types of data you wish to synchronize automatically. (A check mark indicates the feature is enabled.)

**Note:** If you do not want to sync your Google account automatically, touch  at the upper right corner and confirm  is displayed.

**Note:** If you want to remove the account, press **Menu**  > **Remove account**.

# Phone

---

With the network and your device's calling feature, you can enjoy clear calling across the country.

[Make Phone Calls](#)

[Receive Phone Calls](#)

[Voicemail](#)

[Phone Call Options](#)

[Call Log](#)

## *Make Phone Calls*

There are several convenient ways to place calls from your device.

[Call Using the Phone Dialpad](#)

[Call From Recent Calls](#)

[Call From People](#)

[Call a Number in a Text Message](#)

[Call Emergency Numbers](#)



[Call Numbers with Pauses](#)

[Call Using Plus \(+\) Code Dialing](#)



[Call Using the Internet Calling](#)

## *Call Using the Phone Dialpad*

The most "traditional" way to place a call is by using the phone's dialpad.





1. Press **Home** , and touch  to display the phone screen.
2. Touch the number keys on the dialpad to enter the phone number.



3. Touch  on the bottom of the screen to call the number.
4. To end the call, touch .



## Call From Recent Calls



The Recent Calls list lets you quickly place calls to recent incoming, outgoing, or missed numbers.

1. Press **Home** , and touch  to display the phone screen.
2. Touch  to display the Call log list.
3. Touch the phone icon  next to a number or a People entry to place a call.
  - For additional options, touch the name or number.

## Call From People

You can place phone calls directly from entries in your People list.



1. Press **Home** , and touch  to display the phone screen.
2. Touch  to display the People list. Your frequent People entries are displayed at the top of the list.

- Touch  to search your People entry.
- Press **Menu**  > **Contacts to display** to select a list which contains your People entries.

3. Touch the entry you want to call and then touch the number to place a call.



## Call a Number in a Text Message

While viewing a message, you can place a call to a number that is in the body of the message.

1. Press **Home** , and touch  > **Messaging**.
2. Touch the message with the phone number.
3. The Phone screen then opens, with the phone number automatically filled in and ready to be dialed. To place the call, touch .

## Call Emergency Numbers

You can place calls to 911 even if the device's screen is locked or your account is restricted.

1. Flick  to unlock the screen, if the device's screen is locked. For more information, see [Turn Your Screen On and Off](#).
2. Touch  on the Home screen.
3. Touch .

To call the 911 emergency number when the device's screen is locked with a pattern, PIN, or password (see [Screen Lock](#)):

1. Touch **Emergency call** on the screen.
2. Touch .

## Enhanced 911 (E911) Information

This device features an embedded Global Positioning System (GPS) chip necessary for utilizing E911 emergency location services where available.

When you place an emergency 911 call, the GPS feature of your device seeks information to calculate your approximate location. Depending on several variables, including availability and access to satellite signals, it may take up to 30 seconds or more to determine and report your approximate location.





**Important:** Always report your location to the 911 operator when placing an emergency call. Some designated emergency call takers, known as Public Safety Answering

Points (PSAPs), may not be equipped to receive GPS location information from your device.

## Call Numbers with Pauses





You can dial phone numbers with pauses for use with automated systems, such as voicemail or credit card billing numbers.

There are two types of pauses available on your device:

- **Add 2-sec pause:** Automatically sends the next set of numbers after two seconds.
  - **Add wait:** Sends the next set of numbers when you touch **Yes** in the pop-up window.
1. Press **Home** , and touch  and enter all or part of a number.
  2. Press **Menu** , and touch **Add 2-sec pause** or **Add wait**.
  3. Enter additional numbers.
  4. Touch  to dial the number.

## Call Using Plus (+) Code Dialing

When placing international calls, Plus Code Dialing automatically enters the international access code for your location (for example, 011 for international calls made from the U.S.). See [North American Dialing](#).



1. Press **Home** , and touch  to display the phone screen.
2. Touch and hold  until you see a “+” on the display screen.
3. Enter the country code and phone number, and then touch . The device automatically prepends the access code for international dialing, followed by the country code and phone number.

## Call Using the Internet Calling

When Wi-Fi network is available, you can make and receive calls through an Internet calling account.

**Important:** Calling a phone number using Internet calling may incur additional charges.



### Adding an Internet Calling Account

1. Press **Home** , and touch  to display the phone screen.
2. Press **Menu** , and touch **Settings**.



3. Touch **Accounts** under **INTERNET CALL SETTINGS**.
4. Touch **ADD ACCOUNT**.
5. Enter your account details and touch **SAVE**.
6. To set your phone to receive Internet calls on your added account, touch the **Receive incoming calls** check box.

**Note:** This requires the phone to maintain a connection with a Wi-Fi data network, which reduces the life of your phone's battery.

## Making an Internet Call

1. Press **Home** , and touch  > **People**.
2. Touch an entry, and then touch **Internet call**.

## Changing Internet Calling Settings

1. Press **Home** , and touch  to display the phone screen.
2. Press **Menu** , and touch **Settings**.
3. Touch **Use Internet calling** under **INTERNET CALL SETTINGS**.
4. Select an option from the following:
  - **For all calls when data network is available** to use Internet calling for all calls when Wi-Fi network is available.
  - **Only for Internet calls** to use Internet calling only for calls to Internet calling addresses.
  - **Ask for each call** to ask each time you make a call.

## Receive Phone Calls

The following information lets you know how to answer incoming calls, mute the ringtone on incoming calls, reject incoming calls, and more.

When you receive a phone call from an entry stored in People, the Incoming call screen appears and displays the caller ID icon, name, and phone number of the calling party. When you receive a phone call from someone who is not stored in People, only the default caller ID icon and phone number appear on the Incoming call screen.

**Note:** If your device is turned off, all calls automatically go to voicemail.

## Answer an Incoming Call

- ▶ On the Incoming call screen, flick the Answer icon .

## Mute the Ringtone

To mute the ringtone without rejecting the call:

- ▶ Press the volume button up or down.

## Reject an Incoming Call

- ▶ Flick the Ignore icon  to send the call to your voicemail inbox.

## Reject a Call and Send a Text Message

You can automatically send a text message to a caller and reject the incoming voice call.

- ▶ Flick the Ignore & Text icon  to ignore the call and send a message to the caller.

# *Voicemail*

You should set up your voicemail and personal greeting as soon as your device is activated. Always use a password to protect against unauthorized access. Your device automatically transfers all unanswered calls to your voicemail, even if your device is in use or turned off.



## Set Up Voicemail

### Voicemail Notification

### Retrieve Your Voicemail Messages

### Voicemail Settings

## *Set Up Voicemail*

1. Press **Home** , and touch .
2. Touch and hold  to dial your voicemail number.
3. Follow the system prompts to:
  - Create your password.
  - Record your name announcement.
  - Record your greeting.

**Important:** **Voicemail Password** – It is strongly recommended that you create a password when setting up your voicemail to protect against unauthorized access. Without a password, anyone who has access to your device is able to access your voicemail messages.

## Voicemail Notification

There are several ways your device alerts you to a new voicemail message.



- By sounding the assigned notification sound.
- By vibrating the device.
- By displaying  in the notifications area of the status bar when new unheard voicemail message(s) is received. The figure is the number of new messages. This icon means you have 10 unheard new messages.

**Note:** Your device accepts messages even when it is turned off. However, your device notifies you of new messages only when it is turned on and you are in the service area.

## Retrieve Your Voicemail Messages

You can review your messages directly from your device or from any other touch-tone phone.

### Use Voicemail to Access Your Messages

1. Press **Home** , and touch .
2. Touch and hold . If prompted, enter your voicemail password.
3. Follow the voice prompts to listen to and manage your voicemail messages.



**Note:** Depending on your plan, you may be charged when you are accessing your voicemail from your wireless device.

### Use Another Phone to Access Messages

1. Dial your wireless phone number.
2. When your voicemail answers, press the asterisk key (\*) on the phone.
3. Enter your password.

## Voicemail Settings

Follow the steps below if you need to change the voicemail settings.

1. Press **Home** , and touch  to display the phone screen.
2. Press **Menu** , and touch **Settings**.



3. Touch **Voicemail service** under **VOICEMAIL** to select the voicemail service provider.
4. Touch **Voicemail settings** under **VOICEMAIL** to configure the voicemail number if necessary.

## Phone Call Options

Your phone application provides many useful features and options to help you make the most of your calling experience.

[Caller ID](#)







[Call Waiting](#)

[Other Call Settings](#)

[In-Call Options](#)

### Caller ID

Caller ID identifies a caller before you answer the phone by displaying the number of the incoming call. If you do not want your number displayed when you make a call, follow these steps.

1. Press **Home** , and touch .
2. Touch   .
3. Enter a phone number.
4. Touch .

To permanently block your number, call Virgin Mobile Customer Support.

### Call Waiting



When you're on a call, Call Waiting alerts you to incoming calls by sounding beeps. Your device's screen informs you that another call is coming in and displays the caller's phone number (if it is available).

To respond to an incoming call while you're on a call:

- ▶ Flick .



To switch back to the first caller:

- ▶ Touch **Switch calls**.

**Note:** For those calls where you don't want to be interrupted, you can temporarily disable Call Waiting by pressing    before placing your call. Call Waiting is automatically reactivated once you end the call.

## Other Call Settings

### North American Dialing



1. Press **Home**  and touch  to display the phone screen.
2. Press **Menu** , and touch **Settings**.
3. Check **North American dialing** under **OTHER CALL SETTINGS** when placing international calls while in the United States or Canada. See [Call Using Plus \(+\) Code Dialing](#).

### TTY Mode

A TTY (teletypewriter, also known as a TDD or Text Telephone) is a telecommunications device that allows people who are deaf, hard of hearing, or who have speech or language disabilities to communicate by telephone.

Your device is compatible with select TTY devices. Please check with the manufacturer of your TTY device to ensure that it supports digital wireless transmission. Your device and TTY device will connect using a special cable that plugs into your device's headset jack. If this cable was not provided with your TTY device, contact your TTY device manufacturer to purchase the connector cable.

To turn TTY mode on or off:

1. Press **Home**  and touch  to display the phone screen.
2. Press **Menu** , and touch **Settings**.
3. Touch **TTY mode**.
4. Touch **TTY Full**, **TTY HCO**, or **TTY VCO** to turn TTY mode on.

– or –

Touch **TTY Off** to turn TTY mode off.

**Note:** When enabled, TTY mode may impair the audio quality of non-TTY devices connected to the headset jack.

**Warning:**     **911 Emergency Calling**

It is recommended that TTY users make emergency calls by other means, including Telecommunications Relay Services (TRS), analog cellular, and

landline communications. Wireless TTY calls to 911 may be corrupted when received by public safety answering points (PSAPs), rendering some communications unintelligible. The problem encountered appears related to TTY equipment or software used by PSAPs. This matter has been brought to the attention of the FCC, and the wireless industry and the PSAP community are currently working to resolve this.

## In-Call Options

While you're on a call, you will see a number of onscreen options. Touch an option to select it.

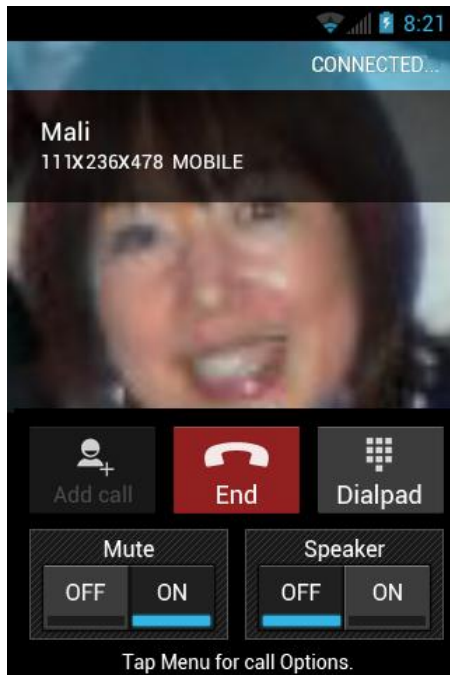

- **End:** End the current call.
- **Dialpad/Hide:** Toggle the appearance of the onscreen dialpad to enter additional numbers, for example, an extension or access code.
  - For example: When you call your bank's 800 number, use your dialpad to enter your account number and PIN.
- **Mute:** Mute the microphone ( ON) during an active call, or unmute the microphone ( OFF).
- **Speaker:** Route the device's audio through the speaker ( ON) or through the earpiece ( OFF).

**Warning:** Because of higher volume levels, do not place the device near your ear during speakerphone use.

Press **Menu**  during a call to display a list of additional in-call features. Touch an option to select it.

- **Contacts:** Display your People list.
- **Bluetooth:** Route the device's audio through a connected Bluetooth headset (checked) or through the speaker (not checked).

## Call Log







The Call log tab of the Phone application lists max. 500 recent incoming, outgoing, and missed calls.

[View Recent Calls](#)

[Call Log Options](#)

[Clear Call Logs](#)





### View Recent Calls



1. Press **Home** , and touch  to display the phone screen.
2. Touch  to display the Call log list.
  - You can determine if an entry was an incoming, outgoing, or a missed call from the icons shown below.
    -  = Incoming Call
    -  = Outgoing Call
    -  = Missed Call

### Call Log Options

- To make a call from Call log, see [Call From Recent Calls](#).





For additional options:

1. Press **Home** , and touch  to display the phone screen.
2. Touch  to display the Call log list.
3. Touch the name to display the options list.
  - Touch  to send a text message.
  - Touch  to view a People entry.

- Touch  to add the number to People.
- Press **Menu**  > **Remove from call log** to remove the log.
- Press **Menu**  > **Edit number before call** to edit the number before calling.

## *Clear Call Logs*

Use the menu option to clear the Call log list.

1. Press **Home** , and touch  to display the phone screen.
2. Touch  to display the Call log list.
3. Press **Menu** , and touch **Clear call log** > **OK**.

# Device Settings

---

This section provides an overview of items you can change using your device's **Settings** menus.

[WIRELESS & NETWORKS Settings](#)

[DEVICE Settings](#)

[PERSONAL Settings](#)

[SYSTEM Settings](#)

## *WIRELESS & NETWORKS Settings*

This group of settings lets you control your device's wireless network settings, Wi-Fi settings, Bluetooth, and more.

[Wi-Fi](#)

[Bluetooth](#)

[Data Usage](#)

[Airplane Mode](#)

[Mobile Networks](#)

### *Wi-Fi*

Your device lets you take advantage of Wi-Fi hotspots for high-speed data access using available computer networks. For details on your device's Wi-Fi features and settings, see [Wi-Fi](#).

### *Bluetooth*



Your device's Bluetooth capabilities let you use wireless headsets, send and receive pictures and files, and more. For details on your device's Bluetooth settings, see [Bluetooth](#).

### *Data Usage*

Your device provides a new data usage chart feature which shows current usage as well as usages in a specific period of time.

#### View Data Usage by Application

You can view the amount of the data usage for the specific period of time.



1. Press **Home**  > **Menu** , and touch **System settings** > **Data usage**.
2. Confirm **Mobile data** is set to .

3. Touch  of **Data usage cycle** to change the period of time for which the chart will display the data usage.
4. Drag the bottom of the white line to set the short period of time you want to see the data usage within that cycle.
  - The usage amount will be displayed just below the chart.

## Set Data Usage Limit



You can also set the limit for mobile data in case you don't have unlimited data plan which cuts off data at a specified threshold.

**Warning:** The usage displayed is measured by your phone. Your carrier's data usage accounting may differ and the usage in excess of your data limit plan can result in charges. Data usage limit set in this menu is not guaranteed to prevent additional charges.

1. Press **Home**  > **Menu** , and touch **System settings** > **Data usage**.
2. Touch to check **Set mobile data limit**. Read the message and touch **OK**.
3. Drag the right side of the red line at the top of the chart to set the limit you want.
  - When your data usage reaches the limit, mobile data will be turned off automatically.
4. Drag the right side of the orange line under the red line to set the level where you receive the warning.
  - When your data usage reaches the level set with the orange line, you will see the message.

## Restrict Data Usage by Application

You can restrict the background data usage.

1. Press **Home**  > **Menu** , and touch **System settings** > **Data usage**.
2. Press **Menu**  > **Restrict background data** to check it.
3. Read the message and touch **OK**.

**Tip:** You can see the Wi-Fi usage. Press **Menu**  > **Show Wi-Fi usage** to check it.

## Airplane Mode

Airplane mode allows you to use many of your device's features, such as Gallery, Camera, and Music, when you are on an airplane or in any other area where making or receiving calls or data



is prohibited. When you set your device to Airplane mode, it cannot send or receive any calls or access online information.

To quickly turn Airplane mode on or off:

- ▶ Press and hold the **Power** button, and then touch **Airplane mode** under Phone options.

While in Airplane mode, the status bar will display .

To turn Airplane mode on or off in Settings:



1. Press **Home**  > **Menu** , and touch **System settings** > **More...** under **WIRELESS & NETWORKS**.
2. Touch the **Airplane mode** check box. While in Airplane Mode, the status bar will display .

## *Mobile Networks*

Mobile networks menu lets you enjoy the data connection.



### Enable Data

Enable data access to enjoy the data connection.

1. Press **Home**  > **Menu** , and touch **System settings** > **More...** under **WIRELESS & NETWORKS**.
2. Touch **Mobile networks** and confirm **Data enabled** is checked.

### Connections Optimizer

Your device can be set to automatically select the best mobile network.

1. Press **Home**  > **Menu** , and touch **System settings** > **More...** under **WIRELESS & NETWORKS**.
2. Touch **Mobile networks** > **Connections Optimizer**.
3. Read the message and touch **I Agree**.

– or –

Touch **More Information** for further details. Read the message and leave the check box checked if you agree, or touch the check box to uncheck if you do not agree.



# DEVICE Settings

The DEVICE settings menu lets you control your device's feature.

Sound

Display

Storage

Battery

PC Connection



Apps

## Sound

Use the following settings for such features as silent mode, vibrate, and overall device volume.

### Volumes



Adjust your device's volume settings to suit your needs and your environment.

1. Press **Home**  > **Menu** , and touch **System settings > Sound > Volumes**.
2. Drag the onscreen slider to adjust the volume level of **Music, video, games, & other media, Ringtone & notifications, or Alarms**.
3. Touch **OK**.

**Tip:** You can adjust the ringtone volume in standby mode (or the earpiece volume during a call) by using the volume button on the left side of your device.

### Silent Mode



The Silent mode option allows you to mute all sounds or vibrate (except for media and alarm sounds).

1. Press **Home**  > **Menu** , and touch **System settings > Sound > Silent mode**.
2. Select your option.
  - **Off** to disable the silent mode.
  - **Vibrate** to mute all sounds but vibrate. You can select the vibrate pattern. See [Vibrate Pattern](#).
  - **Mute** to mute all sounds.

**Tip:** Press the volume button down in standby mode until you see  or  on the screen.

## Phone Ringtone



You can select and assign ringtones for your incoming calls.

1. Press **Home**  > **Menu** , and touch **System settings** > **Sound** > **Phone ringtone**.
2. Touch a ringtone from the available list. The ringtone briefly plays when selected.
3. Touch **OK** to assign a ringtone.

**Tip:** You can assign individual ringtones to your People entries. See [Assign a Ringtone to a People Entry](#).



## Vibrate Pattern

You can select the vibrate pattern.

1. Press **Home**  > **Menu** , and touch **System settings** > **Sound** > **Vibrate Pattern**.
2. Touch a vibrate pattern from the available list. Your phone briefly vibrates when selected.
3. Touch **OK** to assign a vibrate pattern.

## Default Notification

Use the settings menus to assign specific ringtones for notifications.



1. Press **Home**  > **Menu** , and touch **System settings** > **Sound** > **Default notification**.
2. Touch a notification sound from the available list. The sound briefly plays when selected.
3. Touch **OK** to assign a notification sound.

## Vibrate and Ring

Check this option to let your device ring and vibrate simultaneously.

## Persistent Alerts

This menu lets you set alerts, such as beep, vibration, or LED blinking for notification.

1. Press **Home**  > **Menu** , and touch **System settings > Sound > Persistent alerts**.
2. Check the following.
  - **Audible tone** to beep when notification is on the notification bar.
  - **Vibrate** to vibrate when notification is on the notification bar.
  - **Blink LED** to blink the LED indicator when notification is on the notification bar.

## SYSTEM

The SYSTEM settings menu lets you select whether you hear tones when touching numbers on the dialpad, selecting onscreen options, and more.



- **Dial pad touch tones:** Check to play tones when using the dialpad.
- **Touch sounds:** Check to play sounds when making an onscreen selection.
- **Screen lock sound:** Check to play sounds when locking or unlocking the screen.
- **Vibrate on touch:** Check to vibrate when touching softkeys and during certain other instances.
- **Hearing aid:** Check to use your hearing aid device effectively.

## Display

Adjusting your device's display settings not only helps you see what you want, it can also help increase battery life.

### Brightness

Adjust your screen's brightness to suit your surroundings.

1. Press **Home**  > **Menu** , and touch **System settings > Display > Brightness**.
2. Drag the Brightness slider left or right to adjust the screen brightness.  
– or –  
Check **Automatic brightness** to set the brightness automatically.
3. Touch **OK**.

### Wallpaper

Select wallpaper using this menu.



1. Press **Home**  > **Menu** , and touch **System settings > Display > Wallpaper**.

2. Select the wallpaper you want to display on the screen.

## Auto-rotate Screen

Your device is capable of automatically changing the orientation of some onscreen content. With this feature, you can view the screen in either portrait or landscape orientation by turning the device sideways. By default, the screen orientation automatically changes when the device is rotated.



To deactivate the Auto-rotate feature:

1. Press **Home**  > **Menu** , and touch **System settings** > **Display**.
2. Touch **Auto-rotate screen** check box to uncheck it.

If you open the device and access the slide-out keyboard, the screen automatically changes to the landscape orientation. See [Slide-out QWERTY Keyboard](#).



## Sleep

Select the delay time before the screen automatically turns off.

1. Press **Home**  > **Menu** , and touch **System settings** > **Display** > **Sleep**.
2. Touch a delay time to select it.



## Font Size

Choose the font size of the screen as you like.

1. Press **Home**  > **Menu** , and touch **System settings** > **Display** > **Font size**.
2. Select your desired font size.

## Keyboard Timeout



Select the delay time before the key backlight automatically turns off.

1. Press **Home**  > **Menu** , and touch **System settings** > **Display** > **Keyboard timeout**.
2. Touch a time delay to select it.

## Screen Proximity Safety

Set the distance between your device and your face that triggers your device's proximity sensor to work.

**Note:** If you disable the proximity sensor, it may cause accidental key presses during a call.



1. Press **Home**  > **Menu** , and touch **System settings > Display > Screen proximity safety**.
2. Drag the slider left or right to adjust the distance between your device and your face, and then touch **OK**.

## Storage

The Storage settings menu lets you see the available space of the internal storage and the SD card on your device and provides options for your microSD card. For SD card options, see [microSD Card](#).



## Battery

The battery menu lets you see the current battery status and which applications have been using the battery.

1. Press **Home**  > **Menu** , and touch **System settings > Battery**.
2. Touch "... **on battery**" to see the history details of the battery usage.

## PC Connection



Set your device's default connection mode when connected to the USB port of a computer.

1. Press **Home**  > **Menu** , and touch **System settings > PC connection**.
2. Touch **Default connection type** and select one of the following options.
  - **Charge only:** Let your PC charge your device only.
  - **Mass Storage:** Let your device function as a removable disk when connected to the USB port of a computer.
  - **Media Transfer:** Let your device function as a media device when connected to the USB port of a computer.
3. Check **Ask me** if you want to display the selection screen whenever you connect your device to a computer.

If **Ask me** is checked, the selection screen is displayed whenever you connect your device to a computer. If you want this selection set as default, check **Remember this choice > Done** on the selection screen.

## Apps

This menu lets you view applications on your device.

1. Press **Home**  > **Menu** , and touch **System settings > Apps**.
2. Touch one of the following tabs to select the applications to be displayed.

- **DOWNLOADED:** Select to display downloaded application. You can also see the storage status on your device at the bottom of the screen.
- **ON SD CARD:** Select to display applications stored on the microSD card. You can also see the storage status on your SD card at the bottom of the screen.
- **RUNNING:** Select to display currently running applications. You can also see the RAM status on your device at the bottom of the screen. Touch **SHOW CACHED PROCESSES** to see the cached process of the application.
- **ALL:** Select to display all applications stored on your device and the installed SD card.

## *PERSONAL Settings*

The PERSONAL settings menu lets you manage your personal settings of your device.

[Accounts & Sync](#)

[Location Services](#)

[Security](#)

[Language & Input](#)

[Backup & Reset](#)

### *Accounts & Sync*



The Accounts & sync settings menu lets you add and manage your accounts and synchronizes the calendar or People entries on your device. See [General Sync Settings](#).

### *Location Services*

Your device is equipped with a Location feature for use in connection with location-based services. The Location services menu allows the network to detect your position. Turning the Location services menu off will hide your location from everyone except **911**.



#### **Google's Location Service**

This service uses Wi-Fi and/or mobile networks to detect your location.

1. Press **Home**  > **Menu** , and touch **System settings** > **Location services**.
2. Touch **Google's location service**. (A check mark indicates this feature is enabled.)
3. Read the disclaimer and touch **Agree**.



## GPS Satellites

This service uses available GPS to pinpoint your location within certain applications such as Google Maps Navigation™.

1. Press **Home**  > **Menu** , and touch **System settings > Location services**.
2. Touch **GPS satellites**. (A check mark indicates this feature is enabled.)

## Location & Google Search

This service lets Google use your location to improve search results and other services.

1. Press **Home**  > **Menu** , and touch **System settings > Location services**.
2. Touch **Location & Google search**. (A check mark indicates this feature is enabled.)
3. Read the disclaimer and touch **Agree**.

## Security

The Security settings menus let you set device security, lock codes, passwords, administrator settings, and more.



### Screen Lock

You can choose the way how your device acts when the device's display screen is turned on. As default, you must flick the lock button on the screen. See [Turn the Screen On and Unlock It](#).

The security of your device can be increased by drawing the correct pattern on the screen, entering the correct PIN, or entering the correct password to unlock the device's control keys, buttons, and touchscreen.

If you fail to enter the correct pattern, PIN or password after five attempts, you will have to wait for 30 seconds before you can try again.

Use a Pattern:

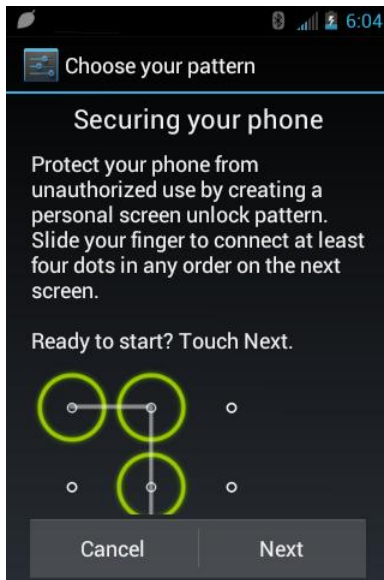

1. Press **Home**  > **Menu** , and touch **System settings > Security > Screen lock**.
2. Touch **Pattern**.





3. Read the information and study the example pattern on the screen and touch **Next**.
4. Draw the screen unlock pattern by connecting at least four dots in a vertical, horizontal, or diagonal direction. Lift your finger from the screen when finished.
5. The device records the pattern. Touch **Continue**.
6. When prompted, draw the screen unlock pattern again, and then touch **Confirm**.

**Note:** Clear the **Make pattern visible** check box if you do not want the pattern to be displayed on the screen when you draw it.

Use a PIN:

1. Press **Home**  > **Menu** , and touch **System settings** > **Security** > **Screen lock**.
2. Touch **PIN**.
3. Enter a PIN and touch **Continue**.
4. Enter your PIN again and touch **OK** to confirm it.

Use a Password:

1. Press **Home**  > **Menu** , and touch **System settings** > **Security** > **Screen lock**.
2. Touch **Password**.
3. Enter a password and touch **Continue**.
4. Enter your password again and touch **OK** to confirm it.





**Note:** Check the **Vibrate on touch** check box if you want the device to vibrate when you draw the pattern or enter the PIN.

**Note:** Touch **Automatically lock** to select the time duration before the screen lock feature activates.

**Note:** Check the **Power button instantly lock** check box if you want the screen lock feature to activate by pressing the **Power** button.

**Note:** Touch **Owner info** to enter your information to be displayed on the lock screen.

Change or Disable the Screen Lock:

1. Press **Home**  > **Menu** , and touch **System settings** > **Security** > **Screen lock**.
2. Draw your unlock screen pattern, or enter your PIN or password and touch **Next**.
3. Touch **None** to disable the screen lock or change the unlock mode. Touch **Slide** to return to the default lock pattern.

## Encrypt Data



You can encrypt your device and the SD card installed in your device.

**Warning:** To unencrypt your device, you need to reset your device to the original factory settings, which erases all data from the device's application storage.

**Warning:** To unencrypt your SD card, you need to format the card, which permanently removes all files stored on the card.

**Note:** Charge the battery enough and connect the device to an electrical outlet.

**Note:** You cannot use other features including making or receiving phone calls during encryption.

1. Press **Home**  > **Menu** , and touch **System settings** > **Security** > **Encrypt data**.
2. Select the following options.
  - **Phone & SD card** to encrypt your device and the SD card installed in your device.
  - **Phone** to encrypt your device only.
  - **SD card** to encrypt the installed SD card only.
3. Read the message and touch **Next**.
4. If you use the security lock with a PIN or password, enter it and touch **Next**.



5. Read the message and touch **Encrypt**.

**Warning:** Do not remove the SD card during the encryption of the SD card, otherwise you will lose some or all of your data.

**Warning:** If you interrupt the encryption process, you will lose some or all of your data.



## Passwords

You can hide your password or PIN number as you type it.

1. Press **Home**  > **Menu** , and touch **System settings** > **Security**.
2. Clear the **Make passwords visible** check box.



## Device Administration

You can disable the authority to be a device administrator of certain applications. If disabled, you will typically lose some functionality in those applications, such as the ability to sync new email or calendar events to your device.

1. Press **Home**  > **Menu** , and touch **System settings** > **Security** > **Device administrators**.
2. Touch an application you want to disable the authority to be a device administrator.



## Unknown Sources

Follow the steps below to install non-Google Play applications.



1. Press **Home**  > **Menu** , and touch **System settings** > **Security**.
2. Touch **Unknown sources** > **OK**. (A check mark indicates this feature is enabled.)

## Credential Storage

You can see the trusted credentials on your device's system.



1. Press **Home**  > **Menu** , and touch **System settings** > **Security** > **Trusted credentials**.
2. Touch to read the information.

You can install encrypted certificates from the SD card.

1. Press **Home**  > **Menu** , and touch **System settings** > **Security** > **Install from SD card**.
2. Touch an available certificate.

3. Follow the onscreen instructions.

You can remove all the credentials on your device.

1. Press **Home**  > **Menu** , and touch **System settings > Security > Clear credentials**.
2. Touch **OK**.

## *Language & Input*

Your device's Language & input settings let you select a language for the device's screens and menus, as well as manage a personal user dictionary. The Keyboard settings let you select a preferred input method, control keyboard settings, and more. For details, see [Enter Text](#).



This menu also provides the settings when using voice function. See [Text-to-speech Settings](#) and [Voice Search](#).

## *Backup & Reset*

This menu helps you to back up and restore your data.



### Back up My Data

You can back up your settings to a Google server.

1. Press **Home**  > **Menu** , and touch **System settings > Backup & reset**.
2. Touch **Back up my data**. (A check mark indicates this feature is enabled.)

### Automatic Restore

Check this option to restore your settings and other data when you install an application.



1. Press **Home**  > **Menu** , and touch **System settings > Backup & reset**.
2. Touch **Automatic restore**. (A check mark indicates this feature is enabled.)

### Factory Data Reset

Your device's Backup & reset menu includes the **Factory data reset** option. This option lets you reset your device to the original factory settings, which erases all data from the device's application storage, including the following options.

- Your Google account
- All other email and social networking accounts
- System and application data and settings
- Downloaded applications

To reset your device:

1. Press **Home**  > **Menu** , and touch **System settings** > **Backup & reset** > **Factory data reset**. Read the Factory data reset information.
2. Touch **Reset phone**.
3. Touch **Erase everything**. Your device will power down and reset itself, which may take up to 10 minutes.

## *SYSTEM Settings*

The SYSTEM settings menu lets you manage the system settings of your device.

[Date & Time](#)

[Accessibility](#)



[Developer Options](#)

[About Phone](#)

[System Update](#)

### *Date & Time*

Your device obtains its time and date information by using the network-provided date, time, and time zone. These values can be changed manually.

1. Press **Home**  > **Menu** , and touch **System settings** > **Date & time**.
2. Clear the **Automatic date & time** check box if necessary.
3. Clear the **Automatic time zone** check box if necessary.
4. Touch **Set date**. Adjust the date, month, and year by touching ▲ or ▼. Touch **Set** when finished.
5. Touch **Set time**. Adjust the hour, minute, and AM or PM by touching ▲ or ▼. Touch **Set** when finished.
6. Touch **Select time zone**, and then select a time zone from the onscreen list. Scroll down the list to view additional time zones.
7. Touch **Use 24-hour format** to toggle between 12-hour or 24-hour format.
8. Touch **Select date format** to select how the date information is displayed on your device.



## Accessibility

You can download and manage accessibility-related applications or configure the accessibility setting of your device.

**Note:** You can also enable your TTY (teletypewriter, also known as a TDD or Text Telephone) settings. See **TTY mode** within the [Other Call Settings](#) section.



## SERVICES

This menu provides you the list of accessibility-related applications. Touch the application and configure its settings.

1. Press **Home**  > **Menu** , and touch **System settings** > **Accessibility**.
2. Touch an application to configure its settings.



### TalkBack

TalkBack is an application to help blind and vision-impaired users use their devices more easily. It adds spoken, audible, and vibration functionality services to your device.

1. Press **Home**  > **Menu** , and touch **System settings** > **Accessibility**.
2. Touch **TalkBack**.
3. If **OFF** is displayed at the right of **TalkBack**, touch it to turn **TalkBack** on.
4. Read the message and touch **OK**. **ON** is displayed.
5. Touch **SETTINGS** and configure the TalkBack settings

## SYSTEM

This menu configures the accessibility settings of the system in your device.

1. Press **Home**  > **Menu** , and touch **System settings** > **Accessibility**.
2. Configure the following system accessibility settings.
  - **Large text** to use large fonts on the screen.
  - **Power button ends call** to use the **Power** button to end a call.
  - **Auto-rotate screen** to automatically change the orientation of some onscreen content when the device is rotated.
  - **Speak passwords** to let your device speak the password you enter.

- **Explore by touch** to let your device speak or write the descriptions of what's under your finger (when **TalkBack** is turned on).
- **Touch & hold delay** to set the delay time when the screen recognizes the touch and hold operation.
- **Install web scripts** to install web scripts that make the web content more accessible.

## *Developer Options*

These menus are specific for application development. Unless you have a specific reason for changing these settings, you should leave them at the default settings.

## *About Phone*

The About phone menu lets you access important phone information including your phone number, and view legal information.

## *System Update*

From time to time, updates may become available for your device. You can download and apply updates through the System update menu.



### Update Kyocera Software

This option provides you to the latest Android Operating System (OS) and the device software on your device via an over-the-air connection.

Before Updating Your Firmware:



Updating your device firmware may erase all user data from your device. You must back up all critical information before updating your device firmware.

To back up your account information:

1. Press **Home**  > **Menu** , and touch **System settings > Accounts & sync**.
2. Touch the account containing data you want to back up now.
3. Press **Menu** , and touch **Sync now**.



As an added precaution, to preserve any data on your microSD card, please remove it from your device prior to starting the update process.

Update Kyocera Firmware:

1. Press **Home**  > **Menu** , and touch **System settings > System update > Update Kyocera software**.



2. Follow the onscreen instructions. (Your device automatically downloads and installs any available updates. You may be required to power your device off and back on to complete the software upgrade.)

Confirm Your Current Device Firmware:

1. Press **Home**  > **Menu** , and touch **System settings** > **About phone**.
2. Scroll to the bottom of the page for the version number.

Reinstall Your Google Application:

Your Google™ application purchases are reloaded remotely and can be re-installed after the update is applied.

1. Log into your Google account via the device.
2. Press **Home** , and touch  > **Play Store**.
3. Press **Menu** , and touch **My Apps**.
4. Scroll through the list of previously downloaded Google applications and choose the one you wish to reinstall.
5. Follow the onscreen instructions.

# People

---

The People application lets you store and manage contacts from a variety of sources, including contacts you enter and save directly in your device as well as contacts synchronized with your Google account or compatible email programs.

[Get Started with People](#)

[Add a New People Entry](#)

[Save a Phone Number](#)

[Edit a People Entry](#)

[Select People List](#)

[Customize People List](#)

[Synchronize People Entries](#)

[Display Options](#)

[Share a People Entry](#)

## *Get Started with People*



Before using People, it's best to learn a few basics.

[Access People](#)

[People List Options](#)

## *Access People*

Follow the steps below to access People.

- ▶ Press **Home** , and touch  > **People**.

There are four tabs on People:



**Groups** to display the Group of entries.



**All** to display all entries.



**Favorite** to display your favorite entries.



**ICE** to display your ICE (in case of emergency) entry.



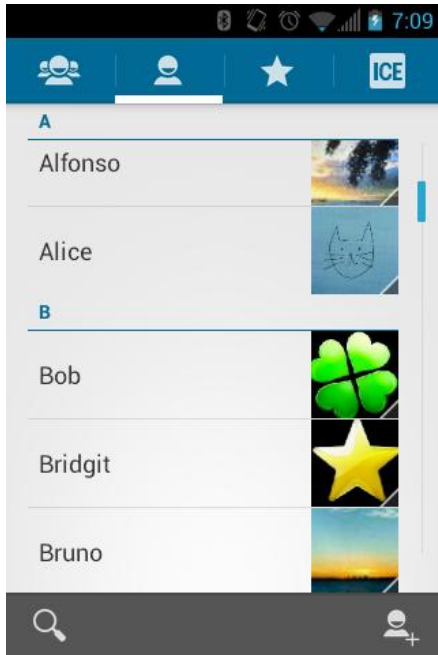



Scroll through the list to view all your entries. To see a specific entry, scroll to it and touch it.

## *People List Options*

You can manage your entries from the People list.



- Touch  to add an entry. See [Add a New People Entry](#).
- Touch  to search an entry.

You can also press **Menu**  to display the People list options.

- **Contacts to display:** Selects the People list to be displayed. See [Select People List](#).
- **Import/export:** Imports/exports entries from/to the microSD card.
- **Accounts:** Opens the Accounts & sync settings screen. See [Accounts & Sync](#).
- **Settings:** Opens the Display options screen. You can select how your entries are displayed. See [Display Options](#).

## *Add a New People Entry*

Enter details such as name, phone numbers, email addresses, mailing addresses, and more.

1. Press **Home** , and touch  > **People**.
2. If this is the first time to open the People application, select where to save a new entry.
  - **Existing** to save a new entry to your existing Google account.

- **New** to save a new entry to your new Google account.
- **Not now** to save a new entry in your device only.

3. Touch .

- You may be prompted to select a type of the entry.
  - Select your **Google** account to save an entry to.
  - Select **Add new account** to save an entry to your new account. Select **Google** or **Corporate**.
  - They will be synced automatically with your Google account online.

4. Use the keyboard to enter as much information as you want.

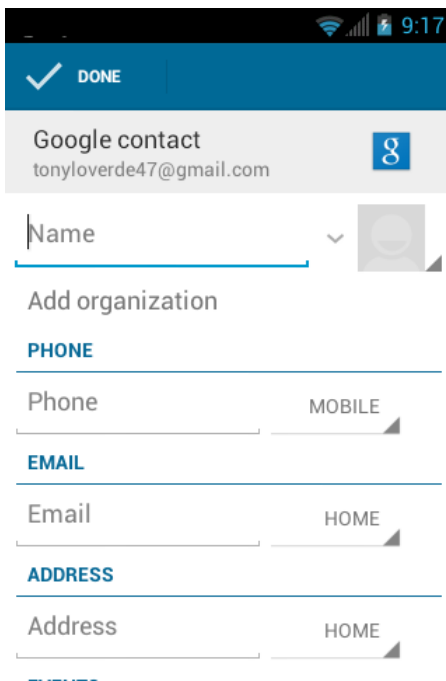

-  **(People icon)**: Touch to assign a photo to the entry. See [Assign a Stored Picture to a People Entry](#) or [Assign a New Picture to a People Entry](#).
- **Name**
- **Add organization**
- **PHONE**
- **EMAIL**
- **ADDRESS**

- **EVENTS**
- **GROUPS**
- **Add another field:** Touch to include additional information such as IM (address), Notes, Nickname, Website, Internet call, etc.





**Note:** To select a type (label) for a phone number, email address, or postal address (such as Mobile, Home, Work, etc.), touch the type to the right of the field.

**Note:** To add more phone numbers, email addresses, etc., touch **Add new** under the current numbers or addresses.

5. When you have finished adding information, touch **DONE**.

## Save a Phone Number

You can save a phone number to People directly from the phone dialpad.

1. Press **Home** , and touch  > .
2. Enter a phone number and press **Menu** , and touch **Add to contacts**.
3. To add the number to an existing entry, scroll through the list and touch the entry or touch Find contacts to find the entry. To add a new entry, touch **CREATE NEW CONTACT**.
4. For an existing entry, select a number type for the new number, and then touch **OK**.
5. For a new entry, enter the name and any additional information, and then touch **DONE**. See [Add a New People Entry](#).

## Edit a People Entry

Once you've added an entry, you can add or edit any of the information in the entry, assign a caller ID picture, customize it with a unique ringtone, and more.

[Add or Edit Information for a People Entry](#)

[Assign a Stored Picture to a People Entry](#)

[Assign a New Picture to a People Entry](#)

[Assign a Ringtone to a People Entry](#)

[Assign a Vibration to a People Entry](#)



[Add an Entry to Favorites](#)

[Send an Entry's Call to Voicemail](#)

## Delete a People Entry

### Add or Edit Information for a People Entry



Use the **Edit** menu to add or edit information for an existing entry.

1. Press **Home** , and touch  > **People**.
2. Touch an entry to display it, and then press **Menu** , and touch **Edit**.
3. Touch any field you want to change or add. See [Add a New People Entry](#).
4. Add or edit the information, and then touch **DONE**.

**Note:** To select a type (label) for a phone number, email address, or postal address (such as **Mobile, Home, Work, etc.**), touch the type at the right of the field.





### Assign a Stored Picture to a People Entry

The **Edit** menu lets you assign a picture stored in your device's memory or SD card to an entry.

1. Press **Home** , and touch  > **People**.
2. Touch an entry to display it, and then press **Menu** , and touch **Edit**.
3. Touch the entry icon at the right of the name.
4. Touch **Choose photo from Gallery** and select a location.
5. Touch a picture to select it.
  - You may be prompted to size the picture for use with entries. Touch and drag the square to frame the portion of the picture to use. Touch and drag the side of the square to resize the square and touch **CROP**.
6. Touch **DONE** to save the entry.

### Assign a New Picture to a People Entry

Follow the instructions to take a new picture and assign it directly to an existing entry.



1. Press **Home** , and touch  > **People**.
2. Touch an entry to display it, and then press **Menu** , and touch **Edit**.
3. Touch the entry icon at the right of the name.
4. Touch **Take photo**.
5. Touch  to take the photo. If you're satisfied with the picture, touch  to continue.

- You may be prompted to size the picture for use with entries. Touch and drag the square to frame the portion of the picture to use. Touch and drag the side of the square to resize the square and touch **CROP**.

6. Touch **DONE** to save the entry.



## *Assign a Ringtone to a People Entry*

Know who's calling without looking at your device by assigning a specific ringtone to an entry.

1. Press **Home** , and touch  > **People**.
2. Touch an entry to display it, and then press **Menu**  > **Set ringtone**.
3. Touch an available ringtone.
  - When you touch a ringtone, you will hear a sample.
4. Touch **OK** to assign the ringtone.



## *Assign a Vibration to a People Entry*

You can assign a specific vibration pattern to a People entry.

1. Press **Home** , and touch  > **People**.
2. Touch an entry to display it, and then press **Menu**  > **Set vibrate**.
3. Touch an available vibration.
  - When you touch a vibration, you will feel a vibration.
4. Touch **OK** to assign the vibration.



## *Add an Entry to Favorites*

The Favorites tab of the Phone menu is a listing that can help you quickly access your most used or preferred People entries.

1. Press **Home** , and touch  > **People**.
2. Touch an entry.
3. Touch the star at the upper right corner. The star turns to white.

## *Send an Entry's Call to Voicemail*



You can transfer your entry's voice call to voicemail anytime you receive it.

1. Press **Home** , and touch  > **People**.

2. Touch an entry to display it, and then press **Menu** .
3. Check **All calls to voicemail**.



## Delete a People Entry

You can delete an entry from the entry's details page.

1. Press **Home** , and touch  > **People**.
2. Touch an entry to display it, and then press **Menu**  > **Delete**.
3. Touch **OK**.



## Select People List

Display the People list you like if you have multiple Google accounts.

1. Press **Home** , and touch  > **People**.
2. Press **Menu**  > **Contacts to display**.
3. If you save multiple accounts, select the account. People entries saved in the account will be displayed.
  - If you select **All contacts**, all the entries you saved will be displayed.

## Customize People List

You can customize the People list of the account.



1. Press **Home** , and touch  > **People**.
2. Press **Menu**  > **Contacts to display**.
3. Touch **Customize** and touch the account.
4. Check the types of entries to be displayed or uncheck those types you don't wish to display.
5. Touch **OK**.

## Synchronize People Entries

Syncing data from your managed accounts allows you to add and manage a new or existing entry from your online or remote accounts to your device. Prior to syncing, you must first have an active Google or Corporate account with current People entries, and be signed into your account via the device.

With syncing, any entries (with phone numbers, email addresses, pictures, etc.) are updated and synced with your device.

For more information about syncing existing managed accounts, see [General Sync Settings](#).

1. Press **Home**  > **Menu** , and touch **System settings** > **Accounts & sync**.
2. Touch the account you want to sync your People with.
3. Touch the **Sync Contacts** check box to select the feature. (A check mark indicates this feature is enabled.)



**Note:** The process of updating your People can take several minutes. If after 10-20 minutes, your list has not been updated, repeat steps 2 and 3.

Your **People** then reflects any updated entry information.

- This update process works both ways. For example, any changes on the device are updated to your Gmail contacts list after sync.



## Display Options



Select how the People list is displayed.

1. Press **Home** , and touch  > **People**.
2. Press **Menu**  > **Settings**.
3. Set the following options.
  - **Sort list by** to choose how your entries are sorted.
  - **View contact names as** to choose how the names of your entries are displayed.

## Share a People Entry

You can quickly share People entries using Bluetooth, Email, or Gmail.

1. Press **Home** , and touch  > **People**.
2. Touch an entry to display it, and then press **Menu** , and touch **Share**.
3. In the **Share contact via** menu, select a method:
  - **Bluetooth** to send the information via Bluetooth. See [Bluetooth](#) for information on pairing and sending via Bluetooth.

- **Email** to send the information as an email attachment. If prompted, select an email account. Address the message, add a subject and a message, and then touch  . See [Compose and Send Email](#) for details on sending email.
- **Gmail** to send the information as a Gmail attachment. Address the message, add a subject and a message, and then touch  . See [Send a Gmail Message](#) for details.



# Messaging

---

With the data service and your device's messaging capabilities, you have the opportunity to share information through many different channels and accounts.

[Gmail](#)

[Email](#)

[Text Messaging and MMS](#)

[Social Networking Accounts](#)

[Google Talk](#)

## Gmail

Gmail is Google's web-based email service. You need to setup your [Google Account](#) in advance.



[Access Gmail](#)

[Send a Gmail Message](#)

[Read and Reply to Gmail Messages](#)

## Access Gmail

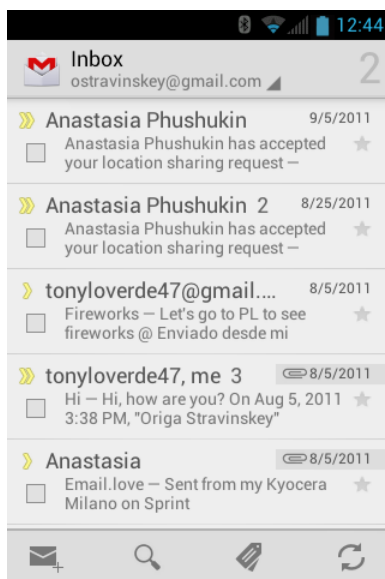

Your device allows you to access, read, and reply to all your Gmail messages.

1. Press **Home** , and touch  > **Gmail**.



2. Do any of the following:
  - View more email messages: If the Inbox is full, swipe your finger up the screen to view more messages and conversations.
  - Read a new email message: Touch the unread message or the conversation with an unread message (just-arrived items display in bold).
  - Select messages and conversations: Touch the box before the email or conversation.
  - View the Inbox of your other Gmail account. Touch **Inbox** at the top of the screen and select the account you want to view its inbox.
  - Refresh the Inbox: Touch .

## Send a Gmail Message

1. Press **Home** , and touch  > **Gmail**.
2. Touch .
3. Enter the message recipient's email address in the **To** field. If you're sending the email message to several recipients, separate the email addresses with a comma. As you enter email addresses, any matching addresses from your People list are displayed. Touch a match to enter that address directly.

**Tip:** If you want to send a CC or a BCC of the email to other recipients, press **Menu** , and touch **Add Cc/Bcc**.

4. Enter the subject, and then compose your message.



**Note:** If you want to attach a picture, press **Menu** , and then touch **Attach file**. Locate and then touch the picture you want to attach.

5. After composing your message, touch .





**Note:** While composing the message, press **Menu**  > **Save draft** if you want to send it later. To open a draft email, in the email account Inbox, touch **Inbox** (top of the Gmail screen), and then touch **Drafts**.

**Note:** To view your sent messages in the Inbox, touch **Inbox**, and then touch **Sent**.

## Read and Reply to Gmail Messages

1. Press **Home** , and touch  > **Gmail**.
2. Touch a message to display it.

**Tip:** You can also access new messages through the status bar. When a new Gmail message arrives, you'll see the  icon in the status bar. Slide the bar down to display notifications. Touch a message to display it.

3. To reply to or forward a message:
  - Touch  to reply to the message.
  - Touch  > **Reply all** to reply to all recipients.
  - Touch  > **Forward** to forward the message.
4. After composing your message, touch .

## Email

Use the Email application to send and receive email from your webmail or other accounts, using POP3 or IMAP. You can also access your corporate email and other features on your device.

[Add an Email Account \(POP3 or IMAP\)](#)

[Add a Corporate Account](#)

[Create Another Email Account](#)

[Compose and Send Email](#)

[View and Reply to Email](#)

[Manage Your Email Inbox](#)



[Email General Settings](#)

[Email Account Settings](#)

[Delete an Email Account](#)

### *Add an Email Account (POP3 or IMAP)*

You can add several types of personal email accounts, such as POP3 and IMAP accounts, on your device.



1. Press **Home** , and touch  > **Email**.
2. Enter the Email address and Password for the email account and then touch **Next**.

**Important:** If the account type you want to set up is not in the device database, you will be asked to enter more details. You should get all pertinent information for the email account, such as incoming and outgoing server settings, before you proceed.

3. Confirm the Email settings and touch **Next**.
4. Touch **Next**. The inbox of the account is displayed.

## Add a Corporate Account

If you synchronize your device with your corporate account, you can read, manage, and send email in the same easy way as with a POP3/IMAP account. However, you can also access some powerful Exchange features.

1. Press **Home**  > **Menu** , and touch **System settings > Accounts & sync**.
2. Touch **ADD ACCOUNT**, and then touch **Corporate**.
3. Enter your Email address and Password information, and then touch **Next**. Consult your network administrator for further details.
  - **Email address:** your corporate email address.
  - **Password:** typically your network access password (case-sensitive).
4. Enter a **Domain\Username**, **Password**, and **Server information** and touch **Next**.
  - **Domain\Username:** enter your network domain\login username.
  - **Password:** typically your network access password (case-sensitive).
  - **Server:** your exchange server remote email address. Typically it is in the form mail.XXX.com. Obtain this information from your company's network administrator.
5. If your network requires SSL encryption, touch the **Use secure connection (SSL)** box to place a check mark and activate this additional level of security. If your exchange server requires this feature, leaving this field unchecked can prevent connection.
6. If the onscreen activation disclaimer is displayed, touch **Next**.
7. Configure your Inbox checking frequency, Days to sync (days to synchronize between your device and server), and activate any other email settings, then touch **Next**.

**Note:** Signal interruptions or incorrect user name or password information can cause completion issues.

8. Identify your new account with a unique name and provide the outgoing name, then touch **Done**.



**Note:** You can have multiple corporate email accounts active on your device.

**Note:** Your corporate Exchange Server must support auto-detect for the device to automatically set up the Exchange ActiveSync account. If your corporate Exchange

Server does not support auto-detect, you will need to enter your Exchange Server settings after you touch **Next**. Ask your Exchange Server administrator for details.



## Create Another Email Account

While you are viewing one email account, you can access the tool to create another email account.

1. Press **Home** , and touch  > **Email**.
2. Press **Menu** , and touch **Settings**.
3. Touch **ADD ACCOUNT**.
4. Enter the Email address and Password for the email account and then touch **Next**.
5. Confirm the Email settings and touch **Next**.
6. Touch **Next**. The inbox of the account is displayed.

## Compose and Send Email

Compose and send email using any account you have set up on your device. Increase your productivity by attaching files such as pictures or videos to your email messages.



1. Press **Home** , and touch  > **Email**.
2. On the email account Inbox, touch .

**Tip:** Touch displayed email address to select a different email account.

3. Enter email addresses directly in the **To** field. If you're sending the email to several recipients, separate the email addresses with a comma. As you enter email addresses, any matching addresses from your People list are displayed. Touch a match to enter that address directly.

**Tip:** If you want to send a CC or a BCC of the email to other recipients, press **Menu** , and touch **Add Cc/Bcc**.





4. Enter the subject, and then compose your message.
5. To add an attachment, press **Menu** , and touch **Attach file**, and choose from the following options:
  - **Pictures:** Select photos from Gallery.
  - **Videos:** Select videos from Gallery.
  - **Audio:** Select sound files.

6. Touch  to send the message immediately, or press **Menu**  > **Save draft** as draft if you want to send it later.

**Note:** To open a draft email, in the email account Inbox, touch **Inbox** (top of the Email screen), and then touch **Drafts**.







## View and Reply to Email

Reading and replying to email on your device is as simple as it is on your computer.

1. Press **Home** , and touch  > **Email**.
2. On the email account Inbox, touch the message you want to view.
3. Touch  or  > **Reply all** to reply to the message.

## Manage Your Email Inbox

### View Your Email Inbox

1. Press **Home** , and touch  > **Email**.
2. Touch the account whose mails you want to view.
  - Touch  to search an email.
  - Touch  to display folders.
  - Touch  to refresh your email box.
  - Press **Menu**  > **Settings** to display the Email settings. See [Email General Settings](#) and [Email Account Settings](#).

### Refresh an Email Account

Whatever your automatic synchronization settings are, you can also synchronize your sent and received email messages manually at any time.

- ▶ While in the account you want to synchronize, touch .

### Delete an Email Message



1. On the email account Inbox, touch the message you want to delete (the message is checked).
2. Touch .

## Delete Multiple Email Messages

1. On the email account Inbox, touch the check box of the messages you want to delete.
2. Touch .



## Email General Settings

You can edit the general settings of your email.

1. Press **Home** , and touch  > **Email**.
2. Press **Menu**  > **Settings** > **General**.
  - **Auto-advance:** Choose which screen to show after you delete a message.
  - **Message text size:** Select the message text size.
  - **Reply all:** Check if you want to display “Reply all” option as default.
  - **Ask to show pictures:** Touch if you want to be asked before pictures in messages to be displayed.

## Email Account Settings

You can edit settings for your individual email accounts, such as email address and password, name display and signature, frequency of retrieval, and more.



1. Press **Home** , and touch  > **Email**.
2. Press **Menu**  > **Settings**.
3. Select the account you want to edit the settings of.
4. Set the following options:
  - **Account name:** Edit your account name.
  - **Your name:** Edit your name displayed on your emails.
  - **Signature:** Create an email signature for your outgoing emails.
  - **Quick responses:** Edit the text you frequently insert when composing emails.
  - **Default account:** Check to assign this account as the default email used for outgoing messages.
  - **Inbox check frequency:** Touch to select the time interval used by your device to check your new emails from **Automatic (Push)** (corporate account only), **Never**,

**Every 5 minutes, Every 10 minutes, Every 15 minutes, Every 30 minutes, and Every hour.**

- **Days to sync:** Set a period of time to synchronize your account (corporate account only).
- **Sync email:** Check to synchronize your email (corporate account only).
- **Sync contacts:** Check to synchronize your contacts (corporate account only).
- **Sync calendar:** Check to synchronize your calendar (corporate account only).
- **Download attachments:** Check if you want to automatically download attachments via Wi-Fi.
- **Email notifications:** Check to display the email notification icon on the status bar when a new email is received.
  - **Choose ringtone:** Select a ringtone for new email messages.
  - **Vibrate:** Select a vibration pattern for new email messages.
- **Incoming settings:** Adjust the incoming email parameters, such as username, password, and other incoming connection parameters (ex: IMAP server).
- **Outgoing settings:** Adjust the outgoing parameters, such as username, password, and other outgoing connection parameters (ex: SMTP server, not for a corporate account).
- **Out of office settings:** Set your current status and your message to reply automatically while you are out of the office (corporate account only).
- **Remove account:** Touch to remove the account.

## *Delete an Email Account*

If you no longer want an email account on your device, you can delete it through the email settings menu.

1. Press **Home** , and touch  > **Email**.
2. Press **Menu**  > **Settings**.
3. Select the account you want to delete.
4. Touch **Remove account** > **OK**.



## *Text Messaging and MMS*

With Text Messaging (SMS), you can send and receive instant text messages between your wireless device and another messaging-ready phone.

Multimedia messages, or MMS, can contain text and pictures, recorded voice, audio or video files, or picture slideshows.

See your service plan for applicable charges for messaging.

[Compose Text Messages](#)

[Send a Multimedia Message \(MMS\)](#)

[Save and Resume a Draft Message](#)



[New Messages Notification](#)

[Managing Message Conversations](#)

[Text and MMS Options](#)

### *Compose Text Messages*

Quickly compose and send text messages on your device.

1. Press **Home** , and touch  > **Messaging**.
2. On the Messaging screen, touch . The compose screen opens.
3. Fill in one or more recipients.
  - Enter phone numbers or email addresses in the **To** field. If you're sending the message to several recipients, separate the phone numbers or email addresses with commas. As you enter information, any matching phone numbers or addresses from your People list are displayed. Touch a match to enter that number or address.

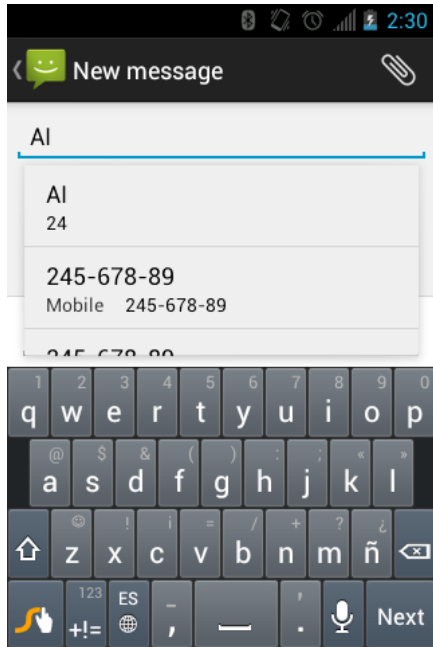



4. Touch **Type message** and then start composing your message.

**Tip:** You can add a subject line by pressing **Menu** , and then touching **Add subject**.

5. When done, touch  to send the text message.

## Send a Multimedia Message (MMS)

When you need to add a little more to a text message, you can send a multimedia message (MMS) with pictures, recorded voices, or audio or video files, or slideshows.

1. Press **Home** , and touch  > **Messaging**.
2. On the Messaging screen, touch . The compose screen opens.
3. Fill in one or more recipients.
  - Enter phone numbers or email addresses in the **To** field. If you're sending the message to several recipients, separate the phone numbers or email addresses with commas. As you enter information, any matching phone numbers or addresses from your People list are displayed. Touch a match to enter that number or address.
4. Touch **Type message** and then start composing your message.



**Tip:** You can add a subject line by pressing **Menu** , and then touching **Add subject**.

5. Touch  and select from the following file attachments.
  - **Pictures:** Open Gallery to attach a photo from your storage card.

- **Capture picture:** Run the camera application to take a photo and attach it.
  - **Videos:** Open Gallery to attach a video from your storage card.
  - **Capture video:** Run the camcorder application to take a video and attach it.
  - **Audio:** Select a ringtone and attach it.
  - **Record audio:** Run the voice recorder application to create a recording and attach it.
  - **Slideshow:** See [Create a Slideshow](#) for details.
6. To make changes to your attachment, touch **Replace** or **Remove**.
7. Touch  to send the MMS message.

## Create a Slideshow



In a multimedia message, you can add slides, each containing a photo, video, or audio.

1. In the multimedia message you're composing, Touch  > **Slideshow**.
2. To compose your slideshow, do any of the following.
  - Touch **Add slide** to create a new slide. (This is a placeholder for new images to be added, similar to a playlist.)
  - Touch the created slide (example, Slide 1), touch **Add picture**, and then select the picture you want to add to the slide.
  - Touch the text field below the image to enter a caption for the picture.
  - Touch **Preview** (to preview the slide), **Replace picture** (to delete the currently selected picture), **Remove slide**, press **Menu** , and touch **Add music**, **Add slide**, **Duration**, or **Layout**.
  - When finished, touch **Done** to attach the slideshow to your message.
3. When you have finished composing the multimedia message, touch  or **Send**.

## Save and Resume a Draft Message



While composing a text or multimedia message, press **Back**  > **Yes** to save your message as a draft.

To resume composing the message:

1. On the Messaging screen, touch the message to resume editing it. “Draft” in red appears at the right of the message in the list.
2. When you finish editing the message, touch , or touch  if you have added attachments to your message.

## *New Messages Notification*

Depending on your notification settings, the device will play a ringtone, vibrate, or display the message briefly in the status bar when you receive a new text or multimedia message. To change the notification for new text and multimedia messages, see [Text and MMS Options](#) for details.

A new message icon  or  also appears in the notifications area of the status bar to notify you of a new text or multimedia message.

To open the message, slide the status bar down to open the Notifications panel. Touch the new message to open and read it. For information on reading and replying to messages see [Managing Message Conversations](#).

## *Managing Message Conversations*

Text and multimedia messages that are sent to and received from a contact (or a number) are grouped into conversations or message threads in the Messaging screen. Threaded text or multimedia messages let you see exchanged messages (similar to a chat program) with a contact on the screen.

To read a text message:

- ▶ Do one of the following:
  - On the Messaging screen, touch the text message or message thread to open and read it.
  - If you have a new message notification, slide the status bar down to open the Notifications panel. Touch the new message to open and read it.



To return to the Messaging screen from a text message thread, press **Back** .

**Note:** To view the details of a particular message, in the message thread, touch the message to open the options menu, and then touch **View details**.

**Note:** If a message contains a link to a Web page, touch the message and then touch the link to open it in the Web browser.

**Note:** If a message contains a phone number, touch the message to dial the number, or touch and hold the message to send a text message to the number or to add the number to your People list.

To view a multimedia message (MMS):



1. Press **Home** , and touch  > **Messaging**.
2. On the Messaging screen, touch a multimedia message or message thread to open it.
3. Touch the attachment to open it.

**Tip:** To save the attachment, touch and hold the message, and then touch **Save attachment** on the options menu.



**Note:** When **Auto-retrieve** in MMS settings is disabled, only the message header is downloaded. To download the entire message, touch the **Download** button at the right side of the message. For details, see [Text and MMS Options](#).

**Note:** If you are concerned about the size of your data downloads, check the multimedia message size before you download it.

To reply with a multimedia message (MMS):

1. Press **Home** , and touch  > **Messaging**.
2. On the Messaging screen, touch a text or multimedia message thread to open it.
3. Touch the text box at the bottom of the screen, enter your reply message, attach files, and then touch  .

To delete a message thread:

1. Press **Home** , and touch  > **Messaging**.
2. On the Messaging screen, touch the message thread that you want to delete.
3. Press **Menu** , and then touch **Delete thread**.
4. When prompted to confirm, touch **Delete**.

To delete a single message:

1. While viewing a message thread, touch and hold the message that you want to delete.
2. From the options menu, touch **Delete**.
3. When prompted to confirm, touch **Delete**.

When you have received a message from someone stored in your People, you can touch the entry's photo or icon in the message thread to open a menu of options. Depending on the stored

entry information, you can view the entry details, phone or send an email message to the entry, and more.

## Text and MMS Options

The messaging settings menu lets you control options for your text and MMS messages including message limits, size settings, and notifications.

1. Press **Home** , and touch  > **Messaging**.
2. Press **Menu** , and then touch **Settings**. You can set the following options.

### STORAGE Settings

- **Delete old messages:** Automatically delete older messages, when the set limits are reached.
- **Text message limit:** Choose the maximum number of text messages to store in each conversation thread.
- **Multimedia message limit:** Choose the maximum number of MMS messages to store in each conversation thread.

### TEXT (SMS) MESSAGES Settings

- **Emergency Alerts:** Sets the federally supervised cell phone alert services to send out broadcast SMS messages for public warning.
  - **Presidential:** Receives an emergency presidential alert. (Presidential is always grayed out [not selectable] and cannot be excluded.)
  - **Imminent Threat - Extreme:** Select this option if you want to receive emergency alerts in an extreme emergency situation (an extraordinary threat to life or property).
  - **Imminent Threat - Severe:** Select this option if you want to receive emergency alerts in a severe emergency situation (a significant threat to life or property).
  - **Amber:** Select this option if you want to receive alerts related to missing or endangered children.
  - **Emergency Alerts Test:** Select this option if you want to receive a test message to make sure that the alert messages can be successfully received.
  - **Help:** Displays the help information for Emergency Alerts.

### MULTIMEDIA (MMS) MESSAGES Settings

- **Auto-retrieve:** Select this option to automatically retrieve all your multimedia messages completely. When selected, the multimedia message header plus the message body and

attachments will automatically download to your device. If you clear this check box, only the multimedia message header will be retrieved and shown in your Messaging screen.

## NOTIFICATIONS Settings

- **Notifications:** Select this option if you want to receive a notification in the status bar when a new text or multimedia message arrives.
  - **Choose ringtone:** Select a ringtone that is specific to new text and multimedia messages. Note that the ringtone briefly plays when selected.
  - **Vibrate:** Select when your device to vibrate when a new text or multimedia message arrives.

## Social Networking Accounts

Stay in touch on the go with all your social networking accounts.

### YouTube

#### YouTube

YouTube™ is a video sharing website on which users can upload and share videos. The site is used to display a wide variety of user-generated video content, including movie clips, TV clips, and music videos, as well as video content such as video blogging, informational shorts and other original videos.

#### Opening YouTube

- ▶ Press **Home** , and touch  > **YouTube**. The library screen appears.



**Note:** If **Terms of Service** appears, touch **Accept if you agree to the Terms of Service**.

#### Watching YouTube Videos

1. On the YouTube screen, touch a video.
2. Touch the screen to show the progress bar at the bottom. Touch the screen while the bar is displayed to pause/play the video. Move the slider on the bar to the left or right to rewind or fast-forward the video.

#### Searching for Videos

1. On the YouTube screen, touch  at the upper right of the screen to open the search box.
2. Enter the keyword to search. Search results appear below the status bar.

3. Touch one of the results, or touch  or .
4. Scroll through the results and touch a video to watch it.

## Google Talk

Google Talk™ is the instant messaging program provided by Google. Google Talk lets you chat with other people that also have a Google account. Your Google Talk account is tied to the Google account you used to set up your device.

[Signing In and Chatting](#)

[Managing Your Friends](#)

[Mobile Indicators](#)

[Signing Out](#)

[Google Talk Settings](#)

### Signing In and Chatting

You need to sign in the Google Talk before starting chatting.

- ▶ Press **Home** , and touch  > **Talk** to open Google Talk.

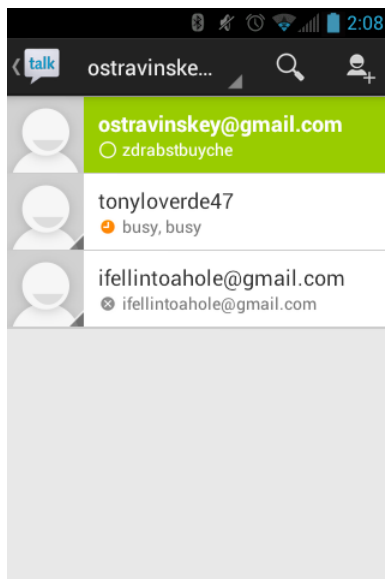

### Adding New Friends

You can add only people who have a Google account.

1. On the friends list screen, touch .



2. Enter the Google Talk ID or the Gmail address of the person you want to add.
3. Touch **DONE**.

## Viewing Your Invitations

On the friends list screen, the friends you invited appear offline in your Friends list until they accept your invitation.

## Accepting and Canceling Invitations

On the friends list screen, touch **Chat invitation**. When an invitation pop-up window appears, touch **Accept** or **Cancel**.

## Changing Your Online Status Message

1. On the friends list screen, touch your email address at the top of the list.
2. Touch the status and select the status you want from the menu.
3. Touch the text box below the online status, and then type your status message.
4. Press **Back** .

## Starting a Chat

1. Touch a friend on the friends list.
2. Touch the text box, and then type your message.
3. Touch .

## Switching Between Active Chats

You can conduct multiple chats at the same time and switch between active chats.

- ▶ On the friends list, touch the friend you want to chat with.

## Closing a Chat

To close a chat, do one of the following:

- ▶ On a chat screen, press **Menu**  > **End chat**.

– or –

On the friends list screen, press **Menu**  > **End all chats**. All the chats will be closed.

## Managing Your Friends

Friends on the friends list screen are sorted according to their online status and are listed alphabetically.

### Viewing the Friends List

You can sort your friends as you like.

- ▶ On the friends list screen, press **Menu** , and touch **Display option**.
  - **Availability** to show the friends that you frequently chat with first and now available first.
  - **Name** to sort all your friends by name.
  - **Recency** to show the friends that you frequently chat with first.

### Blocking Friends

You can block friends from sending you messages.

1. On the friends list screen, touch the name of the friend you want to block.
2. Press **Menu**  > **Friend info** > **Block**. That friend is removed from your friends list and is added to the blocked friends list.

### Unblocking Friends

1. On the friends list screen, press **Menu**  > **Settings** and touch your account.
2. Touch **Blocked friends**.
3. On the blocked friends list, touch the name of the friend you want to unblock.
4. Touch **OK** to confirm.

## Mobile Indicators

Mobile indicators allow you to check your friend's device.

### Checking Friends' Devices

You can see which devices your friends are using to chat in Google Talk.

- If "on Mobile Device" appears below your friend's name, it indicates that your friend is using an Android phone.
- If an email address is displayed, it indicates that your friend is using a computer.

## Displaying a Mobile Indicator

You can choose to show a mobile indicator along with your name to let your friends know the type of wireless device you are using.

1. On the friends list screen, press **Menu** , and touch **Settings**.
2. Touch your account name and check **Mobile indicator**.

## Signing Out

Follow the steps to sign out from the Google Talk.

- ▶ On the friends list screen, press **Menu** , and touch **Sign out** to sign out from Google Talk.

## Google Talk Settings

You can manage the Google Talk settings as you like.

1. On the friends list screen, press **Menu** , and touch **Settings**.
2. Touch your account name and touch any of the following to change the settings.
  - **Mobile indicator:** Select to allow your friends to see the type of wireless device you are using. See [Mobile Indicators](#).
  - **Away when screen off:** Select to show your status as away when the screen is turned off.
  - **Invitation notifications:** Select to show a notification in the status bar when someone invites you to become a friend.
  - **IM notifications:** Select to show a new instant message icon on the status bar when a new instant message is received.
  - **Notification ringtone:** Select if you want the device to ring when a new instant message is received. On the ringtone menu, touch a ringtone to play the tone briefly, and then touch **OK** to confirm selection. Select **Silent** if you do not want the device to ring when a new instant message is received.
  - **Vibrate:** Select if you want the device to vibrate when a new instant message is received.
  - **Video chat notifications:** Select if you want the device to open a dialog or only to show notification when a voice or video chat invitation arrives.
  - **Video chat ringtone:** Select if you want the device to ring when a new video chat notification arrives. On the ringtone menu, touch a ringtone to play the tone briefly,

and then touch **OK** to confirm selection. Select **Silent** if you do not want the device to ring when a new video chat notification arrives.

- **Vibrate:** Select if you want the device to vibrate when a new video chat notification arrives.
- **Blocked friends:** Select to show your blocked friends list.
- **Clear search history:** Select to delete the Google Talk search history.
- **Manage account:** Select to open the Accounts & sync settings menu.
- **Terms & privacy:** Select to show the Google legal information.

# Applications and Entertainment

---

All of your device's features are accessible through the Applications list. Touch the applications launcher icon  on the Home screen.

[Google Play Store App](#)

[Navigation](#)

[Google Play Music App](#)

## *Google Play Store App*

Google Play™ is the place to go to find new Android apps, books, movies, and music for your device. Choose from a wide variety of free and paid content ranging from productivity apps and games to bestselling books and blockbuster movies and music. When you find what you want, you can easily download and install it on your device.

To access the Google Play Store app, you must first connect to the Internet using your device's Wi-Fi or data connection and sign in to your Google account. See [Web and Data](#) and [Sign In to Your Google Account](#) for details.

**Important:** Virgin Mobile's policies often do not apply to third-party applications. Third-party applications may access your personal information or require Virgin Mobile to disclose your customer information to the third-party application provider. To find out how a third-party application will collect, access, use, or disclose your personal information, check the application provider's policies, which can usually be found on their website. If you aren't comfortable with the third-party application's policies, don't use the application.

[Find and Install an Application](#)

[Create a Google Wallet Account](#)

[Request a Refund for a Paid Application](#)

[Open an Installed Application](#)



[Uninstall an Application](#)

[Get Help with Google Play](#)

## *Find and Install an Application*

When you install apps from the Google Play Store app and use them on your device, they may require access to your personal information (such as your location, contact data, and more) or

access to certain functions or settings of your device. Download and install only apps that you trust.

1. Press **Home** , and touch  > **Play Store**. (If a message from Google “Android Market is upgrading to Google play” appears, touch **Continue**.)
2. When you open the Google Play Store app for the first time, the Terms of Service window will appear. Touch **Accept** to continue if you agree to the Terms of Service.
3. Find an application you want and touch it to open its details screen.



**Note:** The Google Play Store screen shots and options may vary depending on the version installed on your device. Your Google Play Store app will update automatically when available.

4. Touch an app to read a description about the app and user reviews.
5. Touch **Download** or **Install** (for free applications) or touch the price button (for paid applications).

**Note:** You need a Google Wallet account to purchase items on Google Play. See [Create a Google Wallet Account](#) to set up a Google Wallet account if you do not have one.

6. The subsequent screen notifies you whether the app will require access to your personal information or access to certain functions or settings of your device. If you agree to the conditions, touch **Accept & download** (for free applications) or **Accept & buy** (for paid application) to begin downloading and installing the app.

If you selected a paid application, after touching **Accept & buy**, you're redirected to the Google Wallet screen to pay for the application before it's downloaded to your device.

**Warning:** **Read the notification carefully!** Be especially cautious with applications that have access to many functions or a significant amount of your data. Once you touch **OK** on this screen, you are responsible for the results of using this item on your device.

## Create a Google Wallet Account

You must have a Google Wallet account associated with your Google account to purchase items from the Google Play Store app.

Do one of the following:

- ▶ On your computer, go to [wallet.google.com](https://wallet.google.com) to create a Google Wallet account.

– or –



The first time you use your device to buy an item from Google Play, you're prompted to enter your billing information to set up a Google Wallet account.

**Warning:** When you've used Google Wallet once to purchase an application from the Google Play Store app, the device remembers your password, so you don't need to enter it the next time. For this reason, you should secure your device to prevent others from using it without your permission. (For more information, see [Security](#).)

## Request a Refund for a Paid Application



If you are not satisfied with an application, you must ask for a refund within 15 minutes of purchase, unless otherwise stated by the app developer. Your credit card is not charged and the application is uninstalled from your device.

If you change your mind, you can install the application again, but you can't request a refund a second time.



1. Press **Home** , and touch  > **Play Store**.
2. Press **Menu** , and touch **My Apps**.
3. Touch the application to uninstall for a refund. The details screen for the application opens.
4. Touch **Refund**. Your application is uninstalled and the charge is cancelled.
  - If requested, choose the reason for removing the application, and then touch **OK**.

## Open an Installed Application

There are several options for opening an installed application.



- ▶ On the status bar, check if you see the  icon. If you see the  icon, open the Notifications panel, and then touch the app to open it.

– or –



1. Press **Home** , and touch .
2. On the All apps screen, locate the app, and then touch the icon.

## *Uninstall an Application*

You can uninstall any application that you have downloaded and installed from the Google Play Store app.

1. Press **Home** , and touch  > **Play Store**.
2. Press **Menu** , and touch **My Apps**.
3. On the INSTALLED screen, touch the application you want to uninstall, and then touch **Uninstall**.
4. When prompted, touch **OK** to remove the application on your device.
  - If requested, choose the reason for removing the application, and then touch **OK**.

– or –

1. Press **Home**  > **Menu** , and touch **System settings** > **Apps**.
2. Touch the **DOWNLOADED** tab and touch the application you want to uninstall, and then touch **Uninstall**.
3. When prompted, touch **OK** to remove the application on your device.
4. Touch **OK**.

## *Get Help with Google Play*

If you ever need help or have questions about the Google Play Store app, press **Menu** , and then touch **Help**. The Web browser will take you to the Google Play Help Web page.

## *Navigation*

Your device offers a number of location-based navigation programs to help you figure out where you are and get you where you're going.

[Google Maps](#)

[Google Navigation](#)



## Google Latitude

### Google Maps

Use this application to find directions, location information, business addresses, etc., all right from your device. Determine your current location with or without GPS, get driving and transit directions, get phone numbers and addresses for local businesses.

#### Opening Google Maps

► Press **Home** , and touch  > **Maps**.

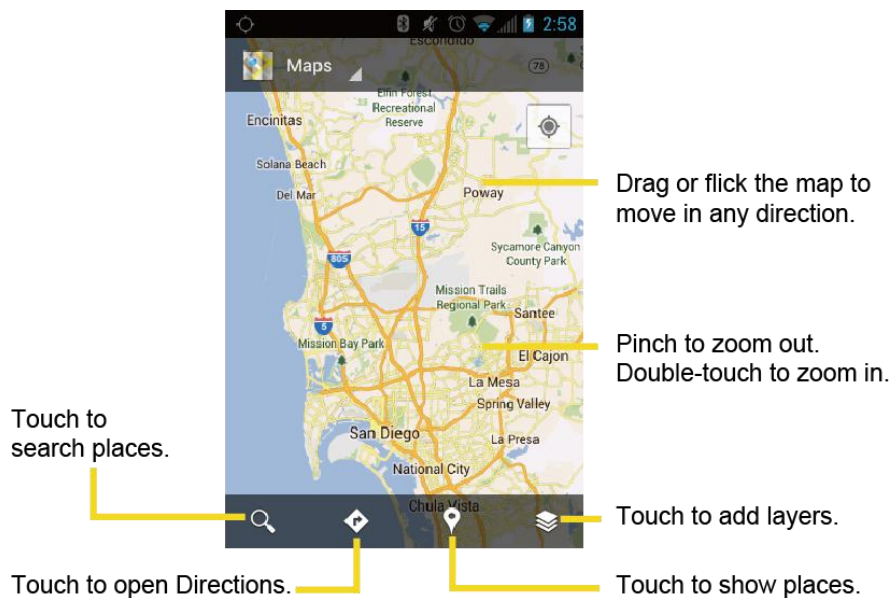

#### Finding Your Current Location

**Note:** Don't forget to set your location sources.

On the Google Maps screen, touch . A blinking blue arrow indicates your current location on the map. This feature is available when **Google's location service** or **GPS satellites** is enabled. See [Location Services](#).

#### Searching Maps

1. On the Google Maps screen, touch .
2. Type the place that you want to search. You can enter an address, a city, or type of establishment.

**Tip:** Touch  to search by speaking the location you are searching.

3. Touch  or . A callout label appears on the map to indicate the location.

4. Touch the callout to open the menu for the location.



## Adding Map Layers

Layers allow you to view locations and additional info overlaid on the map.

On the Google Maps screen, touch  and then touch one or more of the following options:

- **Traffic:** Add this layer to view real-time traffic conditions with roads marked in color-coded lines that indicate the traffic condition. This mode is available in selected areas only.
- **Satellite:** Add this layer to use the same satellite data as Google Earth. The images are not real-time and are approximately one to three years old.
- **Terrain:** Add this layer for a shaded relief view of topographic features.
- **Transit Lines:** Add this layer to provide geographic representations of transit lines. This mode is available in selected areas only.
- **Latitude:** Add this layer to see your friends' locations and share yours with them. You may sign in with your Google account to use this feature.
- **My Maps:** Adds this layer to display Google My Maps on Google Maps of your device.
- **Bicycling:** Adds this layer to provide the road map suitable for bicycling.
- **Wikipedia:** Adds this layer to provide a list of Wikipedia articles that are geo-referenced. An extract of the Wikipedia article can be accessed by clicking on the icon, a link to the full version of the Wikipedia article is also available.

## Getting Directions



1. On the Google Maps screen, touch .
2. Do one of the following:
  - The starting point is set to your current location as default. Touch  to change your starting point place.
  - Touch **End point:** and type your destination or touch  to select the destination from the list.
3. Select the way to get to the destination (by car, by train, or by foot).
4. Touch **GET DIRECTIONS**. The directions to your destination appear in a list or on the map. Touch **NAVIGATION** to open Google Navigation to navigate you to your destination.

## Clearing the Map

When you have reached your destination, press **Menu**  > **Clear Map** to reset the map.

## Google Navigation

Another Google Maps navigation application is available on your device. It provides turn-by-turn voice guided navigation using your current location (provided by GPS communication to your device) to provide various location-based services.

1. Press **Home** , and touch  > **Navigation**.
2. If you see the onscreen disclaimer, read it and touch **Accept** if you agree.
3. Choose from the following onscreen options:
  - **STARRED** tab to obtain directions to the locations that have been starred within Google Maps ([maps.google.com](https://maps.google.com)).
  - **SHORTCUTS** tab
    - **Speak destination** to use the voice recognition feature to search for matching locations in your area.
    - **Type destination** to manually enter a destination address.
    - **Go home** to show the route guidance to your home.
    - **Map** to open the Map application.
    - **RECENT DESTINATIONS** to display a recently searched route.
  - **CONTACTS** tab to receive turn-by-turn directions to the address stored for a selected People entry.

## Google Latitude

Google Latitude™ user location service lets you and your friends share locations and status messages with each other. It also lets you send instant messages and emails, make phone calls, and get directions to your friends' locations.

Your location is not shared automatically. You must join Latitude, and then invite your friends to view your location or accept their invitations.

## Opening Latitude







To join Latitude:

1. Press **Home** , and touch  > **Latitude**.

2. If you see the privacy policy, read it and touch **Agree & Continue** if you agree with it.

After you join Latitude, you can start sharing your locations with your friends. Only friends that you have explicitly invited or accepted can see your location.

To open Latitude after joining:

1. Press **Home** , and touch  > **Latitude**.
2. Select the following options.
  - Touch **MAP VIEW** to see your friend on Google Maps.
  - Touch  to invite your friend to Latitude.
  - Touch  to check in with Latitude.
  - Touch  to refresh the friend list.
  - Press **Menu**  > **Location settings** > **Location reporting** to configure your location reporting and sharing.

## Inviting Friends

To share your location with friends and request to see their locations:

1. In Latitude, touch .
2. Choose how to add friends:
  - **Select from Contacts:** Select any number of friends from People.
  - **Add via email address:** Enter an email address and touch Add friends.
3. Confirm your friend is checked and touch **Yes**.

If your friends already use Latitude, they receive an email request and a notification on Latitude. If they have not yet joined Latitude, they receive an email request that tells them to sign in to Latitude with their Google account.

## Accepting an Invitation

When you get a sharing request from a friend, you see "... new sharing requests" message. Touch it and you can:

- **Accept and share back:** You can see your friends' locations, and they can see yours.
- **Accept, but hide my location:** You can see your friends' locations, but they can't see yours.

- **Don't accept:** No location information is shared between you and your friends.

You can change how your location is shared with each friend at any time. See [Connecting with Your Friends](#) for details.

## Showing Your Friends

You can show your friends using the map view or the list view.

Map View:

Touch **MAP VIEW** on the Latitude screen. Google Maps™ shows your friends' locations. Each friend is represented by a photo icon with an arrow pointing at his or her approximate location. If a friend has opted to enable city-level sharing, his or her icon will not have an arrow and it appears in the middle of the city. See [Connecting with Your Friends](#) for more details.

To see your friend's profile and connect with him or her, touch the photo. This will display your friend's name, and then touch the balloon right above his or her icon.

List View:

To show a list of your friends, in Google Maps, press **FRIENDS LIST**.

To see a friend's profile and connect with him or her, select your friend's name from the list.

## Connecting with Your Friends



Touch a friend's contact details balloon in map view or touch a friend in list view to open the friend's profile. In the profile screen, you can communicate with your friend and set privacy options.

- **Map:** Find a friend's location on the map.
- **Directions:** Get directions to the friend's location.
- **Ping for check in:** Send this friend a notification asking them to check in.
- **Manage sharing:** Select from the following:
  - **Share best available location:** Share your precise location information.
  - **Share only city level location:** Share only the city you are in, not the street-level location. Your friend can see your photo icon in the middle of the city you are in. To share more precise location again, touch **Share best available location**.
  - **Hide from this friend:** Stop sharing your location with this friend, both in list view and in map view.
- **Remove this friend:** Remove the friend from your list and stop sharing locations with him or her altogether.

## Changing Location Settings

You have control over how and when you can be found by your friends. Only the last location sent to Latitude is stored with your Google account. If you turn off Latitude or are hiding, no location is stored.

To change your public profile:

1. Press **Home** , and touch  > **Latitude**.
2. Touch your own name, and then touch **Location settings**.
3. Set the following options to your preferences.
  - **Location reporting:** Let Latitude detect and update your location as you move. The update frequency is determined by several factors, such as how recently your location has changed.
  - **Enable location history:** Store your past location and visualize them on the Latitude website.
  - **Manage your friends:** Add or remove friends who can see your location.
  - **Sign out of Latitude:** Disable Latitude and stop sharing your location or status. You can always join Latitude again.
  - **Automatic check-ins:** Check you into places you have designated.
  - **Check-in notifications:** Enable notifications that suggest places to check in.
  - **Manage your places:** View and modify your automatic check-ins and muted places.

## Google Play Music App

**Play Music** plays digital audio files saved on the storage card. You need to copy music files to your storage card first to use the Google Play Music application. See [Use the Device's microSD Card as a USB Drive](#) for more details on copying files.

**Note:** If you have signed up for Google Music™, the first time you open the Google Play Music application you will be prompted to select the account whose online music library you want to access from the Google Play Music application. Follow the onscreen instructions to continue.

[Open the Play Music Library](#)

[Play Music](#)

[Search for Music in the Play Music Library](#)

## Use Playlists

### Back Up Your Downloaded Music Files

## Open the Play Music Library

Access the Play Music library to enjoy your favorite music.

- ▶ Press **Home** , and touch  > **Play Music**. The Play Music library screen appears.

## Play Music

Learn the basics to use the Play Music application.



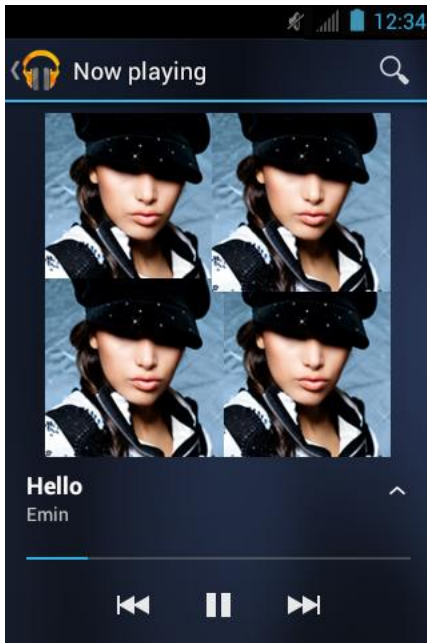

1. On the Play Music library screen, touch a category name to view its contents. Available categories are:
  - **RECENT** to show the albums you have listened to recently.
  - **ARTISTS** to show your music library sorted by artist.
  - **ALBUMS** to show your music library sorted by album.
  - **SONGS** to list all of your songs in alphabetical order.
  - **PLAYLISTS** to select a customized playlist you've created.
  - **GENRES** to show your music library sorted by genre.
2. Touch a song in your library to play it. The Now playing screen opens.  
– or –

Touch the triangular menu button  next to an item and touch **Play**.

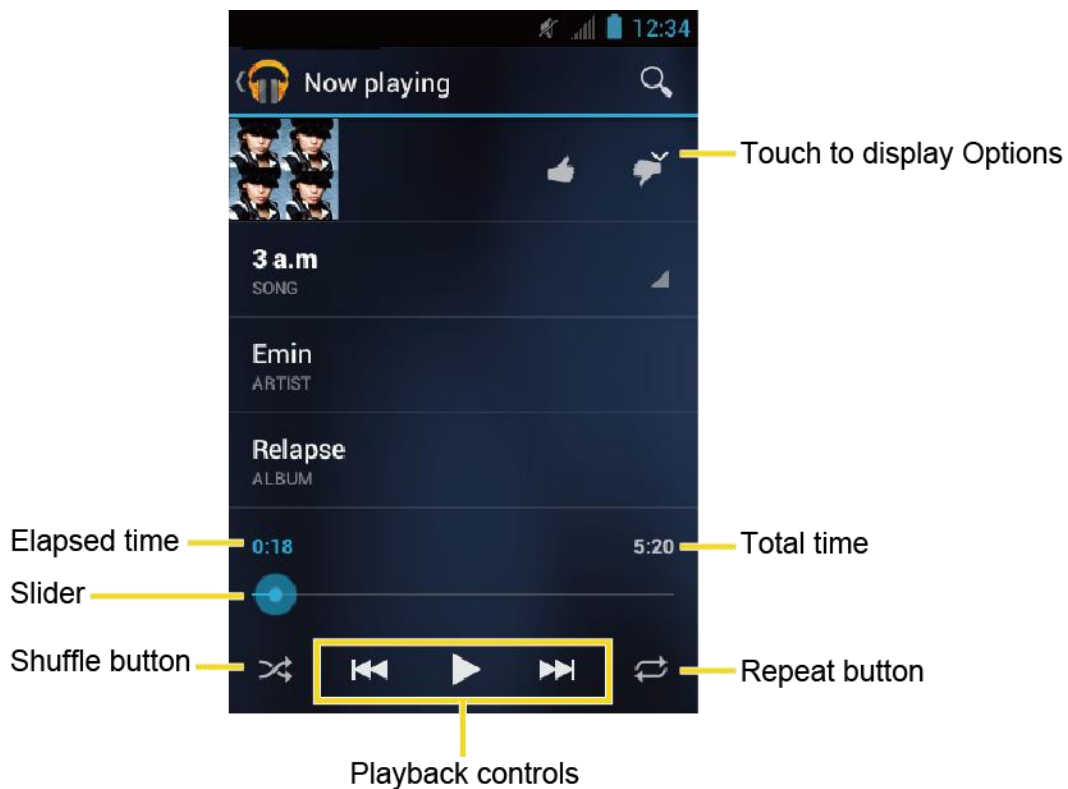



3. Touch  to show options. The following options are available for the control:



- Touch  to pause, or touch  to play again.
- Touch  to go back to the beginning of the current song, and touch  to play the next song in an album.



- Touch the Shuffle button  to toggle shuffle on or off.
- Touch the Repeat button  to cycle through the repeat modes: **Repeating all songs**, **Repeating current song**, or **Repeat is off**.

## Displaying Additional Options

While using the Play Music application you can touch the triangular menu button  next to any song, album, artist, or playlist to view additional options. These options may vary depending on the music data.

- **Play** to play the song.
- **Add to playlist** to add the song to the playlist.
- **More by artist** to show another album of the selected artist.
- **Shop for artist** to open the Google Play Store app and find items related to the artist.
- **Search** to conduct a search using the application that you select.
- **Delete** to delete the song.

**Tip:** To change the settings in the Android Play Music application, press **Menu**  from the Play Music library screen, and then touch **Settings**.

## Search for Music in the Play Music Library

Follow the instructions to find music in your Play Music library.

1. Open the Play Music library and touch the Search button .
2. Start typing the name of the artist, album, song, or playlist you're looking for. As you type, matching information is displayed on the screen.
3. To select a matched item, touch the item.

## Use Playlists

Create a playlist to organize your music.

### Creating Playlists

1. Open the Play Music library and browse for the song that you want to add to the playlist.
2. Touch  next to the song you want to add and touch **Add to playlist**.
3. On the Add to playlist window, touch **New playlist**.

4. Type the name of your new playlist and touch **OK**. After you save the playlist, it's added to the Playlists library.

### Adding Song to Existing Playlists

1. Open the Play Music library and browse for the song that you want to add to the playlist.
2. Touch  next to the song you want to add and touch **Add to playlist**.
3. On the Add to playlist window, touch the name of the playlist that you want to add the song to.

### Removing Song From Playlists

1. Open the Playlists library.
2. Touch the playlist that contains the music you want to remove.
3. Touch  next to the song you want to remove and touch **Remove from playlist**.

### Renaming Playlists

1. Open the Playlists library.
2. Touch  next to the playlist you want to rename and touch **Rename**.
3. Type the new name of the playlist and touch **Rename**.

### Playing Song in Playlists

1. Open the Playlists library.
2. Touch  next to the song you want to play and touch **Play**.

### Deleting Playlists

1. Open the Playlists library.
2. Touch  next to the playlist you want to delete and touch **Delete**.
3. Touch **OK** to confirm.

## *Back Up Your Downloaded Music Files*

Virgin Mobile recommends you back up your downloaded music files to your computer. Although the downloaded files can only be played on your device and on your account, backing them up to your computer lets you access the files in case your microSD card is lost or damaged, or if you install a new microSD card. See [Use the Device's microSD Card as a USB Drive](#).

1. Connect your device to your computer using a USB cable.
2. Use your computer to navigate to the microSD card's Music folder.
3. Select and copy the music files to a folder on your computer's hard drive.

# Web and Data

---

Your device's data capabilities let you wirelessly access the Internet or your corporate network through a variety of connections, including Wi-Fi and Data Services.

This section addresses your device's data connections and the built-in Web browser. Additional data-related features can be found in [Messaging](#), [Applications and Entertainment](#), and [Tools and Calendar](#).

[Wi-Fi](#)

[Data Services](#)

[Browser](#)

## Wi-Fi

Wi-Fi provides wireless Internet access over distances of up to 300 feet. To use your device's Wi-Fi, you need access to a wireless access point or "hotspot."

The availability and range of the Wi-Fi signal depends on a number of factors, including infrastructure and other objects through which the signal passes.





[Turn Wi-Fi On and Connect to a Wireless Network](#)

[Check the Wireless Network Status](#)

[Connect to a Different Wi-Fi Network](#)



### *Turn Wi-Fi On and Connect to a Wireless Network*

Use the WIRELESS & NETWORKS settings menu networks to enable your device's Wi-Fi radio and connect to an available Wi-Fi network.

1. Press **Home**  > **Menu** , and touch **System settings**.
2. If  is displayed at the right of **Wi-Fi**, touch it to turn Wi-Fi on.  is displayed and the device will scan for available wireless networks.
3. Touch **Wi-Fi**. The network names and security settings (open network or secured with WEP/WPA/WPA2 PSK) of detected Wi-Fi networks are displayed.
4. Touch a Wi-Fi network to connect. If you selected an open network, you will be automatically connected to the network. If you selected a network that is secured, enter the key, and then touch **Connect**.

Depending on the network type and its security settings, you may also need to enter more information or choose a security certificate.

When your device is connected to a wireless network, the Wi-Fi icon () appears in the status bar and tells you the approximate signal strength. (The above icon indicates maximum signal strength.)



If **Network notification** is enabled, this icon () appears in the status bar whenever the device detects an available open wireless network within range. Press **Menu** () > **Advanced**, and check **Network notification**.

**Note:** The next time your device connects to a previously accessed secured wireless network, you will not be prompted to enter the security key again, unless you reset your device to its factory default settings.

**Note:** Wi-Fi networks are self-discoverable, which means no additional steps are required for your device to connect to a Wi-Fi network. It may be necessary to provide a user name and password for certain closed wireless networks.

## *Check the Wireless Network Status*



Check the status of your current wireless network, including speed and signal strength, through the WIRELESS & NETWORKS settings menu.

1. Press **Home** () > **Menu** () , and touch **System settings** > **Wi-Fi**.
2. Touch the wireless network that the device is currently connected to. You will see a message box showing the Wi-Fi network name, status, speed, signal strength, and other details.

**Note:** If you want to remove the remembered wireless network settings, touch **Forget** on this window. You need to enter the settings again if you want to connect to this wireless network.

## *Connect to a Different Wi-Fi Network*

Use the WIRELESS & NETWORKS settings to scan for and connect to a different Wi-Fi network.

1. Press **Home** () > **Menu** () , and touch **System settings** > **Wi-Fi**. Detected Wi-Fi networks are displayed in the Wi-Fi networks section. To manually scan for available Wi-Fi networks touch **SCAN**.
2. Touch another Wi-Fi network to connect to it.

**Note:** If the wireless network you want to connect to is not in the list of detected networks, scroll down the screen, and touch **ADD NETWORK**. Enter the wireless network settings and touch **Save**.

# Data Services

With your Virgin Mobile service, you are ready to start enjoying the advantages of data services. This section will help you learn the basics of using your data services, including managing your user name, launching a data connection, and navigating the Web with your device.

**Important:** Certain data services requests may require additional time to process. While your device is loading the requested service, the touchscreen or QWERTY keyboard may appear unresponsive when in fact they are functioning properly. Allow the device some time to process your data usage request.

## Launch a Web Connection

### Data Connection Status and Indicators

## Launch a Web Connection

Launching a Web connection is as simple as opening the browser on your device.

- ▶ Press **Home** , and touch  > **Browser**. (Your data connection starts and you see the home page.)

**Note:** Internet connections can be made either through the data service or via Wi-Fi (configured within the **Settings > Wi-Fi**).



**Tip:** To change the device's default launch page to your current page, press **Menu** , and touch **Settings > General > Set homepage > Current page**.

**Note:** The Browser automatically launches when a Web link is touched from within either an email or text message.

## Data Connection Status and Indicators

Your device displays the current status of your data connection through indicators at the top of the screen.

The following symbols are used:

Icon	Description
	Your device is connected to the 3G Network. When the arrows are animated, your device is transferring data (for example, when you are opening a Web page).
	Your device is connected to the network but is not currently transferring data (for example, when you are viewing a Web page that is completely open).

In any state, you can receive incoming calls.

If you do not see an indicator, your phone does not have a current data connection. To launch a connection, see [Launch a Web Connection](#).

# *Browser*

Your device's Web browser gives you full access to both mobile and traditional websites on the go, using data service, or Wi-Fi data connections.

[Learn to Navigate the Browser](#)

[Browser Menu](#)

[Select Text on a Web Page](#)

[Adjust Browser Settings](#)

[Adjust Browser Privacy and Security Settings](#)

[Adjust Browser Accessibility Settings](#)

[Adjust Browser Advanced Settings](#)

[Adjust Browser Bandwidth Management Settings](#)

[Adjust Browser Labs Settings](#)

[Set Search Engine](#)

[Create Website Settings](#)

[Reset the Browser to Default](#)

[Set the Browser Home Page](#)

[Read Web Page Offline](#)

[Manage Bookmarks](#)

## *Learn to Navigate the Browser*

Navigating through menus and websites during a data session is easy once you have learned a few basics.

**Note:** Before you access the home page, you may be asked to enter your 10-digit wireless phone number and touch **OK**. Entering your phone number is not required for access to other Web pages.

## **Scrolling**

As with other parts of your device's menu, you'll have to drag up and down to see everything on some websites.

To scroll through a website's page:

- ▶ In a single motion, touch and drag across or up and down a page.

## Selecting

To select onscreen items or links:

- ▶ Drag across a page, and then touch or touch an onscreen link to select the link.

Links, which are displayed as underlined text, allow you to jump to Web pages, select special functions, or even place phone calls.

## Go Back

To go back one page:

- ▶ Press **Back**  on your device. Repeat this process to keep going back through your Web page history of recently visited pages.

## Go to a Web Page

1. Touch the Address field (top of the browser window) and enter a new Web address.
  - As you enter the address, possible matches are displayed within an onscreen list. Touch an entry to launch the desired website.
2. Touch **Go** to launch the new page.



**Note:** Not all websites are viewable on your device.

## Browser Menu

The browser menu offers additional options to expand your use of the Web on your device.

### Open the Browser Menu

The browser menu may be opened anytime you have an active data session, from any page you are viewing.

1. Press **Home** , and touch  > **Browser**.
2. Press **Menu** . You will see the browser menu.



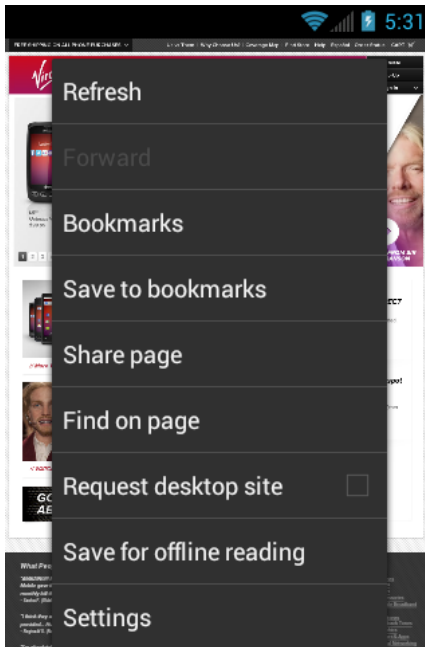

Options available within the browser menu include:

- **Stop:** Stops loading the current Web page.
- **Refresh:** Reloads the current Web page.
- **Forward:** Returns you to a previously viewed page.
- **Bookmarks:** Allows you to access and manage your bookmarks.
- **Save to bookmarks:** Adds the currently viewed page as a bookmark.
- **Share page:** Allows you to send a URL via Gmail, SMS, Email, or Bluetooth.
- **Find on page:** Searches the current Web page for a word.
- **Request desktop site:** Displays the PC site of the current Web page.
- **Save for offline reading:** Saves the current Web page in cache to read it offline.
- **Settings:** Lets you configure and manage your browser settings.

**Note:** These additional options can also be accessed via the QWERTY keyboard by using a combination of the Menu key () and the specified keys.

## *Select Text on a Web Page*

You can highlight text on a Web page and copy it, search for it, or share it.

1. Scroll to the area of the Web page containing the text you want to select.

2. Touch and hold the text you want to copy. Drag tabs to expand or reduce the range of selected text. Any selected text will appear highlighted.

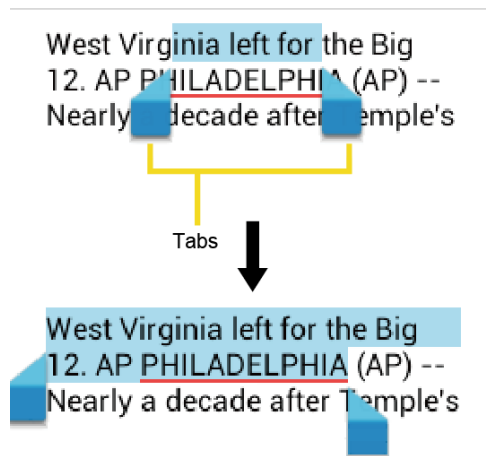



**Tip:** Touch **SELECT ALL** to select all the text on the Web page.

3. Touch  and select the following options.
  - **Copy** to copy the selected text.
  - **Share** to share the selected text via Bluetooth, Gmail, or messaging, etc.
  - **Find** to find the selected text on the Web page.
  - **Web Search** to search the selected text on Internet.



## Adjust Browser Settings

You can change the settings for your browser, including setting your home page, and more.

1. Press **Home** , and touch  > **Browser**.
2. Press **Menu**  and touch **Settings** > **General**.
3. Select from one of the following browser general settings.
  - **Set homepage:** Sets the current home page for the Web browser.
  - **Form auto-fill:** Fills out web forms with a single touch.
  - **Auto-fill text:** Sets up text to auto-fill in web forms.



## Adjust Browser Privacy and Security Settings

You can adjust your browser's privacy and security settings such as whether or not to save passwords, history, or cache.

1. Press **Home** , and touch  > **Browser**.
2. Press **Menu**  and touch **Settings** > **Privacy & security**.
3. Select from one of the following browser privacy and security settings.
  - **Clear cache:** Deletes all currently cached data. Touch **OK** to complete the process.
  - **Clear history:** Clears the browser navigation history. Touch **OK** to complete the process.
  - **Show security warnings:** Notifies you if there is a security issue with the current website. Clear the check mark to disable this function.
  - **Accept cookies:** Allows sites that require cookies to save and read cookies from your device.
  - **Clear all cookie data:** Clears all current browser cookie files. Touch **OK** to complete the process.
  - **Remember form data:** Allows the device to store data from any previously filled-out forms. Clear the check mark to disable this function.
  - **Clear form data:** Deletes any stored data from previously filled out forms. Touch **OK** to complete the process.
  - **Enable location:** Allows sites to request access to your current location (using the built-in GPS function).
  - **Clear location access:** Clears location access for all websites. Touch **OK** to complete the process.
  - **Remember passwords:** Stores user names and passwords for visited sites. Clear the check mark to disable this function.
  - **Clear passwords:** Deletes any previously stored usernames or passwords. Touch **OK** to complete the process.

## *Adjust Browser Accessibility Settings*



You can adjust your browser's accessibility settings such as font size or screen inversion.

1. Press **Home** , and touch  > **Browser**.
2. Press **Menu**  and touch **Settings** > **Accessibility**.
3. Select from one of the following browser accessibility settings.
  - **Force enable zoom:** Overrides a website's request to control zoom behavior.

- **Text scaling:** Changes text size as you see on its preview screen.
- **Zoom on double-tap:** Enables zoom function by double-tapping the screen.
- **Minimum font size:** Sets the minimum font size on the Web as you see on its preview screen.
- **Inverted rendering:** Inverts the screen image. Black becomes white and vice versa. When enabled, you can set the contrast using the Contrast slider.



## *Adjust Browser Advanced Settings*

You can adjust your browser's advanced settings such as setting search engine or default zoom.

1. Press **Home** , and touch  > **Browser**.
2. Press **Menu**  and touch **Settings** > **Advanced**.
3. Select from one of the following browser advanced settings.
  - **Set search engine:** Sets the search engine. See [Set Search Engine](#).
  - **Open in background:** New pages are launched in a separate page and displayed behind the current one. Clear the check mark to disable this function.
  - **Enable JavaScript:** Enables javascript for the current Web page. Without this feature, some pages may not display properly. Clear the check mark to disable this function.
  - **Enable plug-ins:** Allows you to determine the way your device handles program enhancements. Select **Always on**, **On demand**, or **Off**.
  - **Website settings:** Allows you to configure advanced settings for individual websites.
  - **Default zoom:** Sets the default browser viewing size. Choose from: **Far**, **Medium**, or **Close**.
  - **Open pages in overview:** Provides an overview of recently opened pages.
  - **Auto-fit pages:** Allows Web pages to be resized to fit as much of the screen as possible.
  - **Block pop-ups:** Prevents pop-up advertisements or windows from appearing onscreen. Clear the check mark to disable this function.
  - **Text encoding:** Adjusts the current text encoding.
  - **Reset to default:** Resets the browser settings to default.



## Adjust Browser Bandwidth Management Settings

You can adjust your browser's bandwidth management settings.

1. Press **Home** , and touch  > **Browser**.
2. Press **Menu**  and touch **Settings** > **Bandwidth management**.
3. Select from one of the following browser bandwidth management settings.
  - **Search result preloading:** Allows browser to preload high confidence search results in the background.
  - **Load images:** Displays images on Web pages.



## Adjust Browser Labs Settings

You can adjust your browser's labs settings.

1. Press **Home** , and touch  > **Browser**.
2. Press **Menu**  and touch **Settings** > **Labs**.
3. Select from one of the following browser labs settings:
  - **Quick controls:** Opens the Quick controls and hide application and URL bars.
  - **Fullscreen:** Enables the full screen mode and hide the status bar.



## Set Search Engine

You can select the default search engine.

1. Press **Home** , and touch  > **Browser**.
2. Press **Menu**  and touch **Settings** > **Advanced**.
3. Touch **Set search engine** and select a search engine you want to use.

## Create Website Settings



You can create settings for individual websites.

1. Press **Home** , and touch  > **Browser**.
2. Press **Menu**  and touch **Settings** > **Advanced** > **Website settings**.
3. Touch the website you want to create settings. These advanced settings can be configured for individual sites.

4. Touch the settings(for example, **Clear location access**) to complete the process.



## *Reset the Browser to Default*

You always have the option to restore your browser to its default settings.

1. Press **Home** , and touch  > **Browser**.
2. Press **Menu**  and touch **Settings** > **Advanced** > **Reset to default**.
3. Touch **OK** to complete the process.



## *Set the Browser Home Page*

Customize your Web experience by setting your browser's home page.





1. Press **Home** , and touch  > **Browser**.
2. Press **Menu**  and touch **Settings** > **General** > **Set homepage**.
3. Select the page you want to set as a home page. Touch **Current page** to select the current page as the home page.

## *Read Web Page Offline*

You can save web pages for offline reading.

1. Press **Home** , and touch  > **Browser**.
2. Press **Menu** , and touch **Save for offline reading**. The Web page will be saved in **SAVED PAGES** of the bookmark.

To view the saved pages:

1. Press **Home** , and touch  > **Browser**.
2. Press **Menu** , and touch **Bookmarks**.
3. Touch the **SAVED PAGES** tab and select the page you want to view. If you want to view the page online, press **Menu**  > **Go live**.

## *Manage Bookmarks*



Make browsing easier by setting up and using custom bookmarks.

### **Show Bookmarks**



1. Press **Home** , and touch  > **Browser**.

2. Press **Menu** , and touch **Bookmarks**. Three tabs are revealed.
  - **BOOKMARKS**: Displays a list of your current Web bookmarks.
  - **HISTORY**: Displays a record of your browsing history. These records are organized into folders such as: **Today**, **Yesterday**, **Last 7 days**, and **Most visited**.
  - **SAVED PAGES**: Displays a list of websites you saved for offline reading. Touch an entry to launch the selected page.

## Create Bookmarks

1. Press **Home** , and touch  > **Browser**.
2. Open the Web page you want to bookmark.
3. Press **Menu** , and touch **Save to bookmarks**.
4. Enter a descriptive name for the new bookmark.
5. Select an account you want to add the bookmark to.
6. Select where to save the bookmark and touch **OK**.

## Create Bookmarks From History Tab

1. Press **Home** , and touch  > **Browser**.
2. Press **Menu** , and touch **Bookmarks**.
3. Touch the **HISTORY** tab.
4. Touch the star mark at the right of the entry and touch **OK**.

# Camera and Video

---

You can use the camera or camcorder to take and share pictures and videos. Your device comes with a 3.2 megapixel camera that lets you capture sharp pictures and videos.

[Take Pictures](#)

[Record Videos](#)

[Camera/Video Settings](#)

[View Pictures and Videos Using Gallery](#)

[Working with Photos](#)

[Share Photos and Videos](#)

## Take Pictures

**Important:** Make sure the microSD card is installed before you use the camera or camcorder. All pictures or videos that you capture using your device are stored on the microSD card. For more information on how to install a microSD card on your device, see [Insert a microSD Card](#).

[Open the Camera](#)

[Camera Viewfinder Screen](#)

[Review Screen](#)

[Take a Picture](#)

[Close the Camera](#)

## Open the Camera

Follow the instructions below to open the camera in photo mode and take photos.

- ▶ Press and hold the camera button at the lower right side of the device.

– or –

Press **Home** , and touch  > **Camera**.

**Tip:** You can open the camera from the lock screen. Flick .



## Camera Viewfinder Screen

You'll find the following controls on the camera viewfinder screen.



1. **Camera mode icons:** Displays the current camera modes.
2. **Available shots:** Displays the number of shots left available (depending on the capacity of the microSD card).
3. **Zoom slider:** Drag this slider to change the zoom settings. You can also change the zoom settings by pressing the volume button up or down.
4. **Settings button:** Reveals additional camera mode buttons (8-12).
5. **Thumbnail:** Thumbnail of the latest picture. Touch to view and manage.
6. **Shutter button:** Touch to take a picture.
7. **Switch button:** Touch to select camera or camcorder.

8. **Close button:** Touch to close the camera mode buttons (9-12) and return to the zoom slider.
9. **Flash mode button:** Touch to select the flash mode.
10. **White balance button:** Touch this button to change the white balance to enable the camera to capture colors more accurately by adjusting to your current lighting.
11. **Scene mode button:** Touch to select a scene mode.

**Note:** If you select items other than **Auto**, you cannot select **Auto Exposure**, **Flash mode**, and **White balance**.

12. **Camera settings button:** Opens the camera settings menu and lets you change the camera settings. For more information, see [Camera/Video Settings](#).

## Review Screen

After capturing a photo or video, touch the thumbnail to display the review screen. You can instantly share your photos or videos. See [Share Photos and Videos](#). Touch the Gallery icon to edit your photos or replay your videos. See [View Pictures and Videos Using Gallery](#).

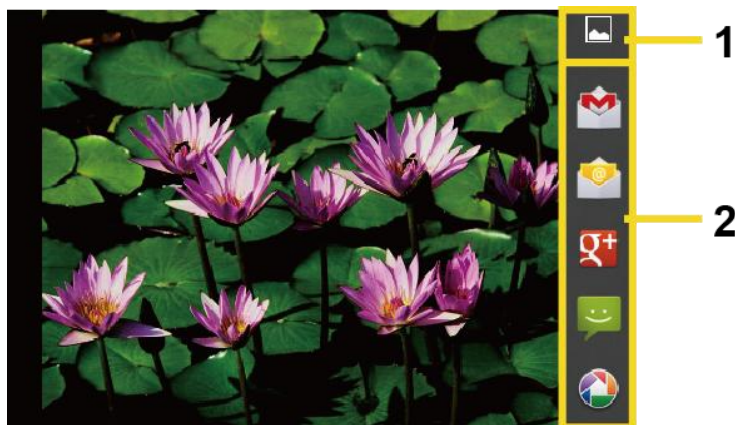

1. **Gallery:** Opens the Gallery application to edit your photo or replay your video.
2. **Share:** Displays the available applications to share your photo or video.

## Take a Picture

You can take high-resolution pictures using your device's camera.

1. Press and hold the camera button at the lower right side of the device.

– or –

Press **Home** , and touch  > **Camera**.

2. Change the settings if necessary.

3. Frame your subject on the screen.

**Tip:** Hold the device vertically when taking portrait shots or hold the device horizontally when taking landscape shots. Then you will not need to rotate the photo after capturing it.

4. Touch  to take the photo.
5. Choose what you want to do with the photo you've just taken. See [Review Screen](#) for details.

## Close the Camera

On the camera screen, press **Home**  or **Back** .

## Record Videos

Record high-quality videos (up to WVGA resolution) using your device's video camera.

### Video Viewfinder Screen

#### Record a Video

## Video Viewfinder Screen



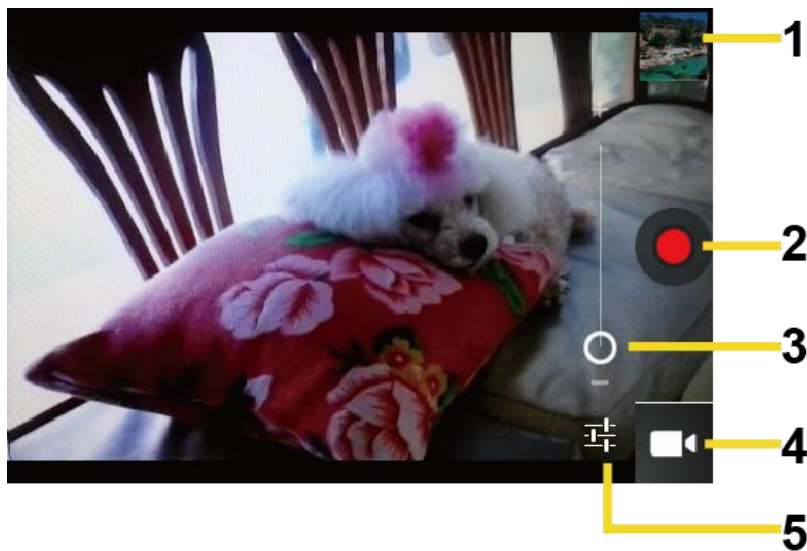

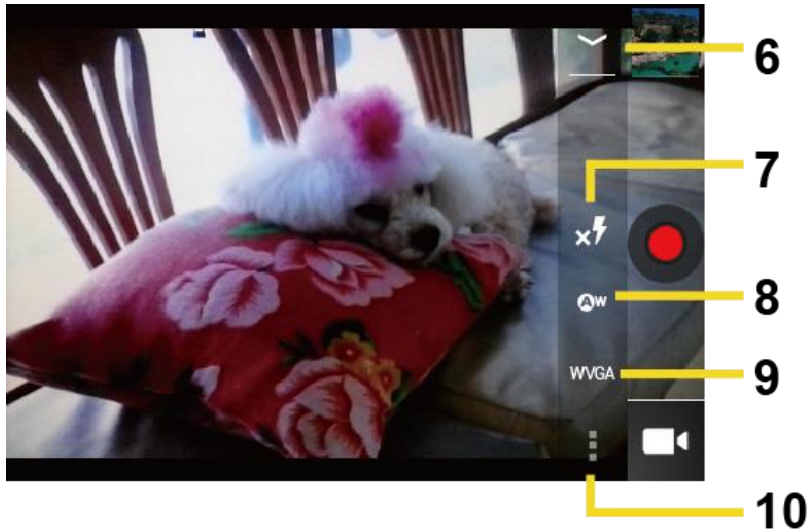
You'll find the following controls on the video viewfinder screen.







1. **Thumbnail:** Thumbnail of the latest video. Touch to view and manage.
2. **Recorder button:** Touch to take a video. Touch again to stop.
3. **Zoom slider:** Drag this slider to change the zoom settings. You can also change the zoom settings by pressing the volume button up or down.
4. **Switch button:** Touch to select camera or camcorder.
5. **Settings button:** Reveals additional video mode buttons (6-10).
6. **Close button:** Touch to close the video mode buttons (7-10) and return to the zoom slider.
7. **Flash mode button:** Touch to select the flash mode.
8. **White balance button:** Touch this button to change the white balance to enable the video to record colors more accurately by adjusting to your current lighting.
9. **Video quality button:** Touch to select a video quality.
10. **Video settings button:** Touch this button to change the video settings. For more information, see [Camera/Video Settings](#).



## *Record a Video*

1. Press and hold the camera button at the lower right side of the device.  
– or –  
Press **Home** , and touch  > **Camera**.
2. Touch  and then touch  to activate camcorder mode.





3. Select **MMS** or **Long video**.
  - **MMS:** Select this option to attach the captured video to your mail. The quality will be automatically set to QCIF (176x144).
  - **Long video:** Select this option to capture a long video. The quality can be selectable.
4. Frame your subject on the screen.
5. Touch  to start capturing video.
6. Touch  to stop capturing.
7. Choose what you want to do with the video you've just captured. See [Review Screen](#) for details.



## Camera/Video Settings

Follow the steps below to change the camera/video settings.

1. Press **Home** , and touch  > **Camera**.

- or -

Press **Home** , and touch  > **Camera** >  > , and then select **MMS** or **Long video**.

2. Touch  and then touch  to show the camera/video settings menu.
  - **Store location:** Stores the location information of the picture/video.
  - **Picture size:** Selects from: **3.2M(2048x1536)**, **2.0M(1600x1200)**, **0.8M(1024x768)**, **VGA(640x480)**, or **HVGA(480x320)** (camera only).
  - **Picture quality:** Selects the quality of the pictures from: **Super fine**, **Fine**, or **Normal** (camera only).
  - **Color effect:** Adds a color effect to the picture. Choose from: **None**, **Mono**, **Sepia**, **Negative**, or **Aqua**.
  - **Auto exposure:** Selects the exposure metering range from: **Frame average**, **Center weighted**, or **Spot metering**.
  - **Restore defaults:** Restores all of the camera/video settings to their default values.

# View Pictures and Videos Using Gallery

Using the Gallery application, you can view photos and watch videos that you've taken with your device's camera, downloaded, or copied onto your microSD card.

For photos that are on your microSD card, you can do editing. You can also easily make a photo as your contact picture or wallpaper and share photos with your friends.

[Open Gallery](#)

[View Photos and Videos](#)



[Zoom In or Out on a Photo](#)

[Watch a Video](#)

[Close Gallery](#)

## Open Gallery

The Gallery application opens in the Albums view where your photos and videos organized by albums for easy viewing.

► Press **Home** , and touch  > **Gallery**.

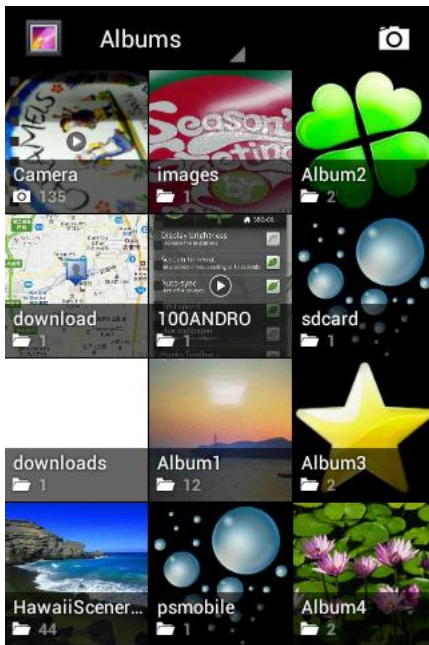

Photos or videos you took with the internal camera are stored in **Camera** album.

Folders in your storage card that contain photos and videos will also be treated as albums and will be listed below **Camera**. The actual folder names will be used as the album names. If you have downloaded any photos and videos, these will be placed in the **download** album.





When viewing pictures in Gallery, scroll left or right the screen to view more albums. Simply touch an album to view the photos or videos in that album.

**Note:** Depending on the number of pictures stored on the microSD card, it may take some time for Gallery to load all your photos on the screen.

## View Photos and Videos

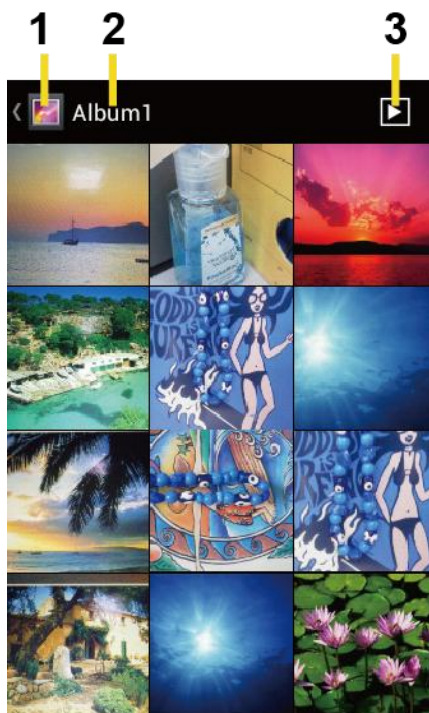
After selecting an album, you can browse through the photos and videos of that album in grid view. Touch a photo or video to view.



1. Touch to go back to the Gallery screen.
  2. Name of the album.
  3. Touch to show the slideshow of pictures in this album.
- ▶ Press **Menu**  to select pictures or sort pictures.

## Zoom In or Out on a Photo

There are two ways you can zoom in or out of a photo.

- ▶ Touch the screen twice quickly to zoom in, then touch the screen twice quickly again to zoom out.
- or –

Pinch the screen using your thumb and forefinger to zoom out or spread the screen to zoom in.

## *Watch a Video*

Use the onscreen controls to play, pause, or stop the video.

▶ Touch  to play the video.

▶ Touch  to pause the video.

## *Close Gallery*

Use the Home key to close the Gallery and return to the Home screen.

▶ While in the Gallery screen, press **Home** .

## *Working with Photos*

You can manage your photos or videos.

[Photo Options Menu](#)

[Edit a Photo](#)

[Rotate and Save a Photo](#)

[Crop a Photo](#)

## *Photo Options Menu*



With the picture displayed, press **Menu**  to show the following menu.

- **Delete:** Deletes the selected picture/video.
- **Slideshow:** Starts the slideshow of the pictures stored.
- **Edit:** Edits the picture. See [Edit a Photo](#).
- **Rotate left/Rotate right:** Rotates the picture. See [Rotate and Save a Photo](#).
- **Crop:** Crops the picture. See [Crop a Photo](#).
- **Details:** Shows the details of the picture.
- **Set picture as:** Sets the picture as the contact photo or wallpaper.
- **Show on map:** Shows the location where you took the picture in Google Maps if Store location is set to ON. See [Camera/Video Settings](#).









## Edit a Photo



Your device has a built in editing tool and you can alter the picture you took easily.

1. Press **Home** , and touch  > **Gallery**.
2. Touch an album and then touch a picture.
3. Press **Menu**  > **Edit**.





4. Touch the following icon to edit the picture and scroll left and right to select your favorite effect.
  -  to add exposure effect.
  -  to add artistic effect.
  -  to add color effect.
  -  to add additional effect.
  -  to undo the action.
  -  to redo the action.
5. When finished, touch **SAVE**.

## Rotate and Save a Photo

1. Press **Home** , and touch  > **Gallery**.
2. Touch an album and then touch a picture.

3. Press **Menu** , and touch **Rotate left** or **Rotate right**.

## *Crop a Photo*

1. Press **Home** , and touch  > **Gallery**.
2. Touch an album, and then touch a picture.
3. Press **Menu** , and touch **Crop**. A crop box then appears on the photo.

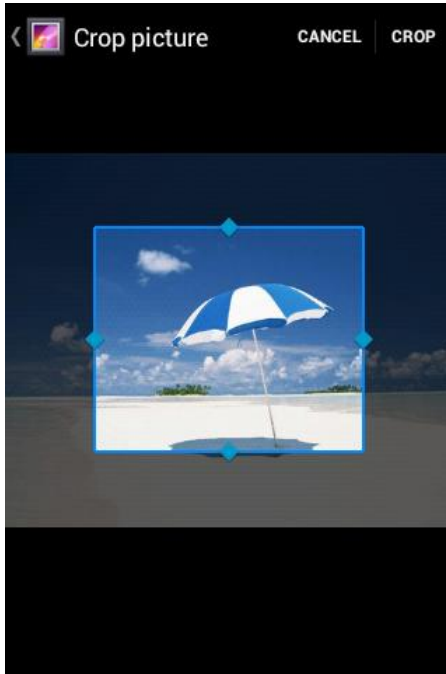

4. To adjust the crop box size, press and hold the edge of the box. When directional arrows appear, drag your finger inward to or outward to resize the crop box.
5. To move the crop box to the part of the photo that you want to crop, drag the crop box to the desired position.
6. Touch **CROP** to apply the changes to the picture.

The cropped picture is saved on the storage card as a copy. The original picture remains unedited.

## *Share Photos and Videos*

The Gallery application lets you send photos and videos using email or multimedia messages. You can share photos on your social networks such as Picasa and share videos on YouTube. You can also send them to another phone or your computer using Bluetooth.

[Send Photos or Videos by Email/Gmail](#)

[Send Photos or Videos by Multimedia Message](#)

[Send Photos or Videos Using Bluetooth](#)





[Share Photos or Videos on Google+](#)

[Share Photos on Picasa](#)

[Share Videos on YouTube](#)

## *Send Photos or Videos by Email/Gmail*





You can send several photos, videos, or both in an email/Gmail message. They are added as file attachments in your email.

1. Press **Home** , and touch  > **Gallery**.
2. Touch the album that contains the photos or videos you want to share.
3. Touch and hold the photo or video until you see a blue frame around it. Touch multiple photos and videos to select them.
4. Touch  > **Gmail** or **Email**. If you cannot find it, touch **See all...**
5. Compose your message and then touch .

**Note:** If you selected **Email** and you have multiple email accounts, the default email account will be used.



## *Send Photos or Videos by Multimedia Message*

Although you can send several photos or videos in a multimedia message, it may be better to just send one at a time, especially if the files are large in size.

1. Press **Home** , and touch  > **Gallery**.
2. Touch the album that contains the photos or videos you want to share.
3. Touch and hold the photo or video until you see a blue frame around it. Touch multiple photos and videos to select them.
4. Touch  > **Messaging**. If you cannot find it, touch **See all...**
5. Compose your message and then touch  .



## *Send Photos or Videos Using Bluetooth*

You can select several photos, videos, or both and send them to another phone or your computer using Bluetooth.

1. Press **Home** , and touch  > **Gallery**.
2. Touch the album that contains the photos or videos you want to share.
3. Touch and hold the photo or video until you see a blue frame around it. Touch multiple photos and videos to select them.
4. Touch  > **Bluetooth**.
5. In the next few steps, you'll be asked to turn on Bluetooth on your device and connect to the receiving Bluetooth device so the files can be sent. For more information, see [Bluetooth](#).





## *Share Photos or Videos on Google+*

You need to be signed in to a Google account to share photos, videos, or both on Google+.

1. Press **Home** , and touch  > **Gallery**.
2. Touch the album that contains the photos or videos you want to share.
3. Touch and hold the photo or video until you see a blue frame around it. Touch multiple photos and videos to select them.
4. Touch  > **Google+**.
5. Follow the instructions on the screen.



## *Share Photos on Picasa*

You need to be signed in to a Google account to upload pictures to the Picasa™ photo organizing service.

1. Press **Home** , and touch  > **Gallery**.
2. Touch the album that contains the photos you want to share.
3. Touch and hold the photo until you see a blue frame around it. Touch multiple photos to select them.
4. Touch  > **Picasa**.
5. Select the online album where you want to upload the pictures, or touch  to create a new album.
6. Touch **Upload**. You can view the photos online at [picasaweb.google.com](http://picasaweb.google.com).

## Share Videos on YouTube

You can share your videos by uploading them to YouTube™. Before you do this, you must create a YouTube account and sign in to that account on your device.

1. Press **Home** , and touch  > **Gallery**.
2. Touch the album that contains the videos you want to share.
3. Touch and hold the video until you see a blue frame around it. Touch multiple videos to select them.
4. Touch  > **YouTube**.
5. Enter the prompted information, such as description and tags, and select a privacy option.
6. Touch **Upload**.

# Tools and Calendar

---

Learn how to use many of your device's productivity-enhancing features.

[Calendar](#)

[Clock & Alarm](#)

[Calculator](#)

[Voice Service](#)

[Eco Mode](#)

## Calendar

Use Calendar to create and manage events, meetings, and appointments. Your Calendar helps organize your time and reminds you of important events. Depending on your synchronization settings, your device's Calendar stays in sync with your Calendar on the Web, or the corporate calendar.

[Add an Event to the Calendar](#)

[Invite Guests to Your Event](#)

[Event Alerts](#)

[View Events](#)



[Erase Events](#)

[Show or Hide Calendars](#)

[Synchronize Calendars with Your Device](#)

### *Add an Event to the Calendar*

Add events to your calendar directly from the Calendar application.

1. Press **Home** , and touch  > **Calendar**.
2. On any Calendar view, press **Menu** , and touch **New event**.
3. If you have more than one calendar, select a calendar in which to add the event.

**Note:** You can create multiple Google Calendars only in Google Calendar on the Web. After creating them in Google Calendar on the Web, you'll be able to see them in the

Calendar application on your device. For more information about creating and managing multiple Google Calendars, visit the Google website: [calendar.google.com](https://calendar.google.com).

**Note:** If you have synchronized your device with a corporate account, you can also select these calendars.

4. Enter a name for the event.
5. Enter the event location.
6. To specify the date and time of the event, do one of the following:
  - If there is a time frame for the event, touch the **FROM** and **TO** dates and times to set them.
  - If the event is a special occasion such as a birthday or an all-day event, set the **FROM** and **TO** dates, and then select the **ALL DAY** check box.
7. Select the time zone for the event.
8. Enter email addresses to invite guests to your event and add the event descriptions. See [Invite Guests to Your Event](#).
9. If the event occurs on a regular basis, touch the **REPETITION** box and then choose how often the event occurs.
10. Set the event reminder time and select how you are notified.

**Note:** You can add another reminder time in a Google Calendar event. Touch **Add reminder** to add another reminder.

11. Select your status to be displayed on your calendar.
12. Set the privacy status of this event.
13. Touch **DONE**.

## *Invite Guests to Your Event*

If you want to invite guests to your event, you need to create and add the event in your Google Calendar.

An email invitation will be sent to your guests using your Google or Corporate account.

1. Open Calendar and create a new event. Select your Google account (or one of your other Google Calendars). See [Add an Event to the Calendar](#).
2. Add details about the event, such as date and time, location, and more.
3. In the **GUESTS** field, enter the email addresses of everyone you want to invite to the event. Separate multiple addresses with commas.

4. Add the description of the event to be displayed on the email to your guests.
5. Touch **DONE** to add the event to your Google Calendar.

If the people to whom you send invitations use Google Calendar, they'll receive an invitation in Calendar and by email.

## Event Alerts

When your device is turned on and you have an event alarm scheduled, your device alerts you and displays the event summary.

There are several ways your device alerts you to scheduled events:

- By playing the assigned ringtone or vibration.
- By showing the  icon on the status bar.
- By showing the Alert pop-up screen.

## Event Reminders

If you have set at least one reminder for an event, the upcoming event icon  will appear in the notifications area of the status bar to remind you of the upcoming event.

To view, dismiss, or postpone the reminder:

1. Slide the status bar down to open the Notifications panel.
2. Touch the upcoming event name to display the event.

**Note:** If you have other pending event reminders, these events will also appear on the screen.

3. Do one of the following:
  - Touch **Snooze all** to postpone all event reminders for five minutes.
  - Touch **Dismiss all** to dismiss all event reminders.
  - Press **Back**  to keep the reminders pending in the notifications area of the status bar.

To set reminder settings:

- ▶ On any Calendar view, press **Menu** , and touch **Settings > General settings**, and set the items under **REMINDER SETTINGS**.



## View Events

You can display the Calendar in daily, weekly, monthly, or agenda view. To change the Calendar view, touch the month and year displayed at the upper left corner, and touch **Day**, **Week**, **Month**, or **Agenda**.

The color of the events indicate the type of calendar that includes the event. To find out what each color represents, press **Menu** , and then touch **Calendars to display**.

## Day View and Agenda Views

Day view displays a list of the events of one day. Agenda view shows a list of all your events in chronological order.

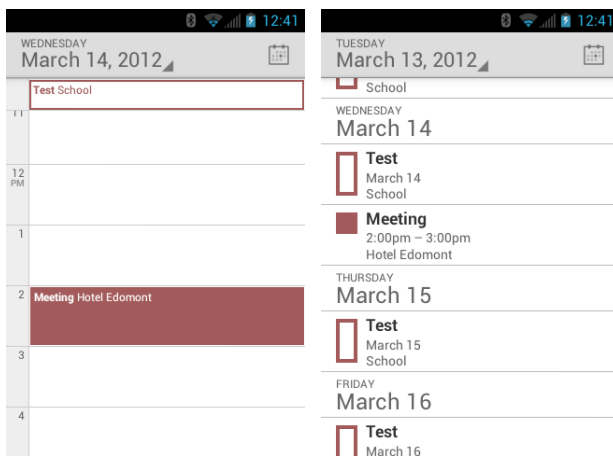

When in Day view, slide left or right across the screen to view earlier or later days.

## Week View

Week view displays a chart of the events of one week.

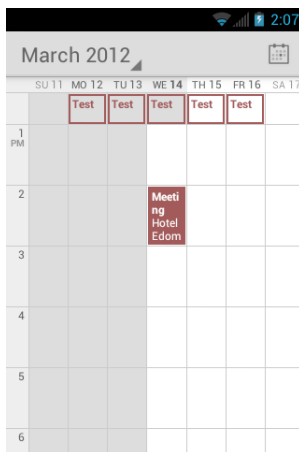

When in Week view:

- You can touch and hold on a time slot to create an event.
- Touch an event to view its details.
- Slide left or right across the screen to view earlier or later weeks.

## Month View

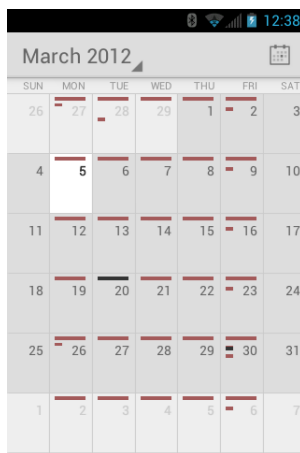

In Month view, you'll see markers on days that have events.



When in Month view:

- Touch a day to view the events of that day.
- Slide up or down the screen to view earlier or later months.

## Erase Events

1. Press **Home** , and touch  > **Calendar**.
  2. Open the calendar event details.
    - In **Agenda**, **Day**, and **Week** views, touch the calendar event you want to delete.
    - In **Month** view, touch the date where the calendar event occurs, and touch the calendar event.
  3. Touch  > **OK**.
- or -

If the calendar event is recurring, select **Only this event**, **This and future events**, or **All events**, and touch **OK**.



## Show or Hide Calendars

- ▶ In any Calendar view, press **Menu** , touch **Calendars to display**, and then touch a calendar to check to display or uncheck to hide it.

## Synchronize Calendars with Your Device

You can choose which Google Calendars to keep synchronized on your phone or which ones to stop synchronizing.

### Synchronize a Google Calendar

1. Press **Home**  > **Menu** , and touch **System settings** > **Accounts & sync**.
2. Touch the account you want to sync with.
3. Touch **Sync Calendar**.
4. In any Calendar view, press **Menu**  > **Calendars to display** > **Calendars to sync**.
5. Check the calendar to sync and touch **OK**.

### Synchronize a Corporate Calendar

If you have set up a corporate account on your device, you can also synchronize corporate calendar events on your device. Calendar events on your corporate account will also show in Calendar if you chose to synchronize with the Exchange ActiveSync Server.

## Clock & Alarm

The Clock application functions as a desk clock that shows the date and time. You can also use it to turn your device into an alarm clock.

[Open Clock](#)

[Set an Alarm](#)

[Change Alarm Settings](#)

### Open Clock

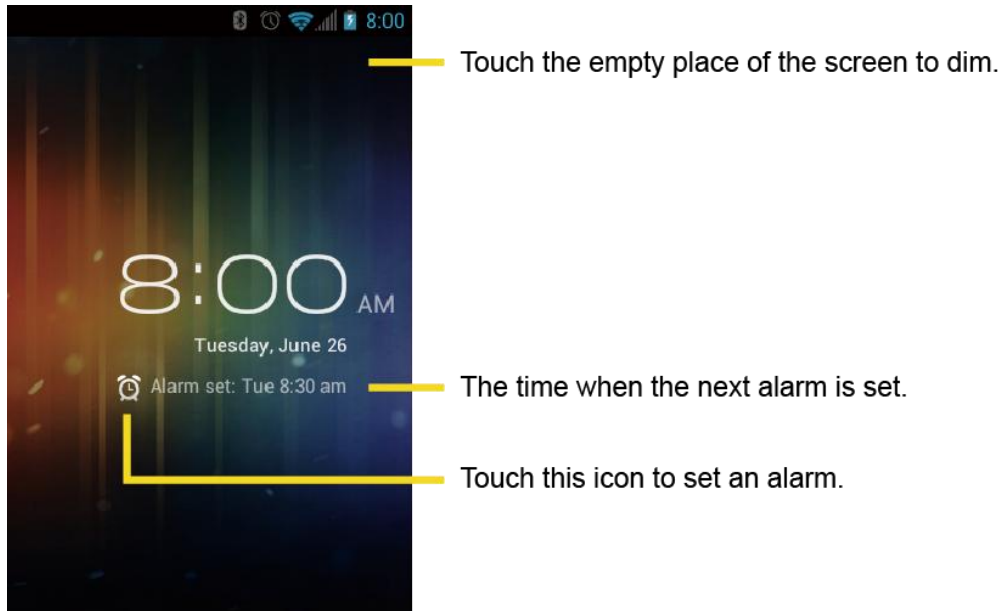

The instructions below show how to open the Clock application.

- ▶ Press **Home** , and touch  > **Clock**.



## Set an Alarm

You can use your device as an alarm clock.

1. Press **Home** , and touch  > **Clock**.
2. Touch  on the screen.

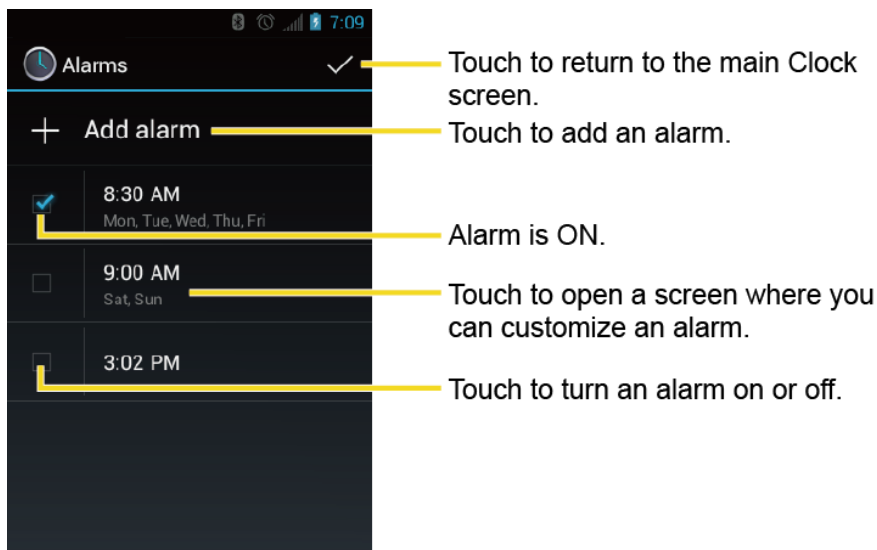



**Note:** When you first open the alarms, two alarms are set up by default and ready for you to customize. These alarms are turned off by default.





3. Touch an existing alarm to change the settings or touch **Add alarm** to add a new one and set the alarm time.

4. Touch **Time** to adjust the hour and minute by touching ▲ or ▼.
5. Touch **Repeat** to select a repeat status for the alarm.
6. Touch **Ringtone** to select a ringtone that will play as an alarm.
7. Touch **Vibrate** to add a vibration feature to the alarm.
8. Touch **Label** to enter a name for the alarm.
9. Touch **Turn alarm on** to set the alarm on.
10. When you're finished, touch **OK**. (Alarms that are set are checked in blue.)
  - Touch the check mark next to an alarm to turn it on or off.

To delete an Alarm:

1. Press **Home** , and touch  > **Clock**.
2. Touch  on the screen.
3. From the Alarms screen, touch a desired alarm, and then touch **Delete**.
4. Touch **OK** to confirm the deletion.





## *Change Alarm Settings*

1. Press **Home** , and touch  > **Clock**.
2. Touch  on the screen.
3. From the Alarms screen, press **Menu** , and touch **Settings**.
4. Configure the following options.
  - **Alarm in silent mode:** Select to sound the alarm even when the device is in silent mode.
  - **Alarm volume:** Select to set the alarm volume.
  - **Snooze duration:** Select to set the snooze duration from 5 to 30 minutes in 5-minute intervals.
  - **Auto-silence:** Select to set how long the alarm sounds.
  - **Volume and Camera:** Select to set the behavior of the volume and camera buttons when pressed while the alarm sounds. Choose from: **None**, **Silence**, **Snooze**, or **Dismiss**.

- **Set default ringtone:** Select to set the ringtone for the alarm.

## Calculator

Your device comes with a built-in calculator.

1. Press **Home** , and touch  > **Calculator**.
2. Enter numbers by touching the onscreen keys.
3. Touch **DELETE** to clear a number. Touch and hold to clear an entire number.
4. To access more advanced features, flick the screen left or press **Menu** , and touch **Advanced panel**.
5. Press **Back**  to close the calculator.

## Voice Service

[Automatic Speech Recognition \(ASR\)](#)

[Text-to-speech Settings](#)

[Voice Search](#)

### Automatic Speech Recognition (ASR)

You can use your device's built-in automatic speech recognition (ASR) software (Voice Dialer) to dial a phone number in your People or to launch device functions. All you have to do is talk into the device, and ASR will recognize your voice and complete tasks by itself.

#### Activate the Voice Dialer



- ▶ Press **Home** , and touch  > **Voice Dialer**.

The device prompts you to say a command from the list displayed on the screen. To complete your task, simply follow the onscreen prompts or touch an onscreen option.

If the application does not recognize the number, name, or application name, it will find the most likely matches and display a list. Touch a selection or touch **Cancel** to exit the Voice Dialer.



**Tip:** Use ASR in a quiet environment so it can accurately recognize your commands.

#### Make a Voice Call with the Voice Dialer



1. Press **Home** , and touch  > **Voice Dialer**.
2. When prompted to speak, say "**Call** [contact]" or "**Dial** [number]."

3. For example, say “**Call John Smith on mobile,**” to call John Smith’s mobile phone. Your device dials the number stored for the contact “John Smith” with the label “Mobile.”

### Open an Application with the Voice Dialer



1. Press **Home** , and touch  > **Voice Dialer**.
2. When prompted to speak, say “**Open [application name].**”
  - For example, say “**Open Calendar,**” to open the Calendar. The application screen is displayed.

### Open a Settings Menu with the Voice Dialer

1. Press **Home** , and touch  > **Voice Dialer**.
2. When prompted to speak, say “**Open [settings menu name].**”
3. For example, say “**Open sound settings.**” The Sound settings menu screen is displayed.

## Text-to-speech Settings

Your device can convert text into speech in some downloaded applications. You may select the language you hear or adjust its speed.

1. Press **Home**  > **Menu** , and touch **System settings** > **Language & input**.
2. Touch **Text-to-speech output** under **SPEECH**.
3. Select your engine. Touch  to configure the settings of the selected engine.
4. Touch **Speech rate** and select a speed.
5. Touch **Listen to an example** to play a short demonstration of the set speech synthesis.

## Voice Search

Voice Search allows you to find information on the web as well as items and information on your device by speaking your search terms.

1. Touch  on the Google Search Bar.



- or -

Press **Home** , and touch  > **Search** > .

2. Speak clearly into the device's microphone. If an error occurs, touch **Speak again** or **Try again**.
3. Touch a matching item from the onscreen list.



## Voice Search Settings

You can configure the settings of the voice search feature.

1. Press **Home**  > **Menu** , and touch **System settings** > **Language & input**.
2. Touch **Voice Search** under **SPEECH**.
  - **Language** to set the language used when entering text by speaking.
  - **SafeSearch** to filter explicit text and images from the search results. Select from **Off**, **Moderate**, or **Strict**.
  - **Block offensive words** to replace recognized offensive words in transcriptions with [#] when entering text by speaking.
  - **Personalized recognition** to improve speech recognition accuracy.
  - **Google Account dashboard** to manage your collected data.

## Eco Mode

The Eco Mode allows you to save battery life while using your device.

1. Press **Home** , and touch  > **Eco Mode**.
2. Drag the onscreen slider to select when you use the Eco Mode.
  - **Never:** Disables the Eco Mode.
  - **10-90%:** Selects the remaining battery power when the Eco Mode activates. For example, 40% means the Eco Mode activates when the remaining battery power reaches 40%.
  - **Always:** Sets your device to always use the Eco Mode.
3. Touch **Eco settings** to select the Eco level.
4. Touch the leaf of the following items to select.
  - **Sleep** to set the screen timeout to 15 seconds.
  - **Display brightness** to decrease the display brightness.
  - **Wallpaper** to select the Eco wallpaper.



- **Auto-sync** to disable automatic synchronization with applications.
- **Haptic feedback** to turn off Haptic feedback feature.
- **Auto-rotate screen** to disable the Auto-rotate screen feature.

5. Touch **Close**.

When Eco Mode is on, the Eco Mode icon  appears on the status bar.

Configured settings in the Eco Mode are automatically reflected in the respective **Settings** menu, and vice versa.

# Bluetooth

---

Bluetooth is a short-range communications technology that allows you to connect wirelessly to a number of Bluetooth devices, such as headsets and hands-free car kits, and Bluetooth-enabled handhelds, computers, printers, and wireless phones. The Bluetooth communication range is usually approximately 30 feet.

[Turn Bluetooth On or Off](#)

[The Bluetooth Menu](#)

[Connect a Bluetooth Headset or Car Kit](#)



[Reconnect a Headset or Car Kit](#)

[Disconnect or Unpair From a Bluetooth Device](#)

[Send and Receive Information Using Bluetooth](#)

## Turn Bluetooth On or Off



Use the Bluetooth menu to enable or disable your device's Bluetooth capabilities.

1. Press **Home**  > **Menu** , and touch **System settings**.
2. If **OFF** is displayed at the right of **Bluetooth**, touch it to turn Bluetooth on. **ON** is displayed and the device will scan for available Bluetooth devices.

**Note:** Turn off Bluetooth when not in use to conserve battery power, or in places where using a wireless device is prohibited, such as aboard an aircraft and in hospitals. Touch **ON** and confirm **OFF** is displayed.

## The Bluetooth Menu

You can access information and controls for your device's Bluetooth feature.

1. Press **Home**  > **Menu** , and touch **System settings > Bluetooth**.
2. Touch your device name (at the top of the list) to set your device visible from other devices.





**Note:** Touch again to set your device not visible from other devices. The time duration in which your device is visible can be changed.

3. Press **Menu**  and set the following options.
  - **Rename phone** to rename your device. See [Change the Device Name](#).

- **Visibility timeout** to select the time duration in which your device is visible from other devices.
- **Show received files** to show the files received using the Bluetooth feature.

## Change the Device Name



The device name identifies your device to other devices.

1. Press **Home**  > **Menu** , and touch **System settings** > **Bluetooth**.
2. If the **Bluetooth** is not turned on, touch **OFF**  to turn Bluetooth on.
3. Press **Menu**  > **Rename phone**.
4. Enter the name for your device in the dialog box, and then touch **Rename**.

## Connect a Bluetooth Headset or Car Kit

You can listen to music over a Bluetooth stereo headset, or have hands-free conversations using a compatible Bluetooth headset or car kit. It's the same procedure to set up stereo audio and hands-free devices.

To listen to music with your headset or car kit, the headset or car kit must support the A2DP Bluetooth profile.



1. Press **Home**  > **Menu** , and touch **System settings** > **Bluetooth**.
2. If the **Bluetooth** is not turned on, touch **OFF**  to turn Bluetooth on.
3. Make sure that the headset is discoverable, so that your device can find the headset. Refer to the instructions that came with the headset to find out how to set it to discoverable mode.
4. Touch **SEARCH FOR DEVICES**. Your device will start to scan for Bluetooth devices within range.
5. When you see the name of your headset displayed in the Bluetooth devices section, touch the name. Your device then automatically tries to pair with the headset.
6. If automatic pairing fails, enter the passcode supplied with your headset.

The pairing and connection status is displayed below the hands-free headset or car kit name in the Bluetooth devices section. When the Bluetooth headset or car kit is connected to your device, the Bluetooth connected icon  is displayed in the status bar. Depending on the type of headset or car kit you have connected, you can then start using the headset or car kit to listen to music or make and receive phone calls.

**Note:** Due to different specifications and features of other Bluetooth compatible devices, display and operations may be different, and functions such as transfer or exchange may not be possible with all Bluetooth compatible devices.

## *Reconnect a Headset or Car Kit*

When you have paired a headset with your device, you should be able to reconnect it automatically by turning on Bluetooth on your device and then turning on the headset. However, sometimes you will need to reconnect manually, for example if you have been using your headset with another Bluetooth device.

1. Press **Home**  > **Menu** , and touch **System settings > Bluetooth**.
2. If the **Bluetooth** is not turned on, touch  to turn Bluetooth on.
3. Make sure that the headset is discoverable.
4. Touch the headset's name in the Bluetooth devices section.
5. If prompted to enter a passcode, try 0000 or 1234, or consult the headset or car kit documentation to find the passcode.
6. If you still cannot reconnect to the headset or car kit, follow the instructions in [Disconnect or Unpair From a Bluetooth Device](#), and then follow the instructions in [Connect a Bluetooth Headset or Car Kit](#).



## *Disconnect or Unpair From a Bluetooth Device*

You can manually disconnect or unpair from a Bluetooth device through the Bluetooth settings menu.

[Disconnect a Bluetooth Device](#)

[Unpair From a Bluetooth Device](#)

### *Disconnect a Bluetooth Device*

1. Press **Home**  > **Menu** , and touch **System settings > Bluetooth**.
2. On the **PAIRED DEVICES** list, touch the device you want to disconnect.
3. Touch **OK**.

### *Unpair From a Bluetooth Device*

You can make your device forget its pairing connection with another Bluetooth device. To connect to the other device again, you may need to enter or confirm a passcode again.

1. Press **Home**  > **Menu** , and touch **System settings > Bluetooth**.

2. On the **PAIRED DEVICES** list, touch  next to the device you want to unpair.
3. Touch **Unpair**.

## *Send and Receive Information Using Bluetooth*





You can use Bluetooth to transfer information between your device and another Bluetooth-enabled device such as a phone or notebook computer. The first time you transfer information between your device and another device, you need to enter or confirm a security passcode. After that, your device and the other device are paired, and you will not need to exchange passcodes to transfer information in the future.

### Send Information From Your Device to Another Device

### Receive Information From Another Device

## *Send Information From Your Device to Another Device*

You can send the following types of information, depending on the device you are sending to.

- Images and videos
  - Contacts information
1. Set the receiving device to discoverable mode. You may also need to set it to “Receive Beams” or “Receive Files.” Refer to the device’s documentation for instructions on receiving information over Bluetooth.
  2. On the device, open the application that contains the information or file you want to send. For example, if you want to send a photo, press **Home** , and touch  > **Gallery**.
  3. Follow the steps for the type of item you want to send:
    - Photo or video (in Camera): After capturing a photo, on the preview screen, touch .
    - Photos and videos (in Gallery): On the Albums tab, touch an album, and select the items you want to share. Touch , and then touch **Bluetooth**.
    - Contacts information: Touch the entry, and then press **Menu** , and touch **Share** > **Bluetooth**.
  4. If you are prompted to turn on Bluetooth, touch **Turn on**.
  5. Touch the name of the receiving device.

6. If prompted, accept the connection on the receiving device, and enter the same passcode on both your device and the other device, or confirm the auto-generated passcode.
7. On the receiving device, accept the file.





The location where the information is saved depends on the type of information and the receiving device:



- If you send a contact, it is normally added directly to the contact application on the receiving device.
- If you send another file type to a Windows computer, it is normally saved in the Bluetooth Exchange folder within your personal document folders.
  - On Windows XP, the path may be: C:\Documents and Settings\[your username]\My Documents\Bluetooth Exchange.
  - On Windows Vista, the path may be: C:\Users\[your username]\Documents.
- If you send a file to another device, the saved location may depend on the file type. For example, if you send an image file to another wireless phone, it may be saved in a folder named “Images.”

## *Receive Information From Another Device*

Your device is capable of receiving a wide variety of file types with Bluetooth, including photos, videos, or contacts.

To receive files from another device, you need to have a microSD card installed in your device.

1. Press **Home**  > **Menu** , and touch **System settings** > **Bluetooth**.
2. If the Bluetooth is not turned on, touch  to turn Bluetooth on.
3. Touch your device name to set it visible from other devices.
4. Press **Menu**  > **Visibility timeout**.
5. Select the time duration in which your device is visible to others.
6. On the sending device, send one or more files to your device. Refer to the device’s documentation for instructions on sending information over Bluetooth.
7. If prompted, enter the same passcode on both your device and the other device, or confirm the auto-generated passcode. If a Bluetooth authorization request is displayed on your device, touch **Pair**.

8. When your device receives a file transfer request notification, the Bluetooth share (Incoming file) icon  is displayed on the status bar. Slide down the notifications panel, and then touch **Bluetooth share: Incoming file > Accept**.
9. When your device receives a file, the Bluetooth share (Received files) icon  is displayed on the status bar. To import a file immediately, slide down the notifications panel, and then touch **Bluetooth share: Received files**.

When you open a received file, what happens next depends on the file type:

- For a vCard contact file, if there are multiple vCard files on your storage card, you can choose to import one, several, or all of those contacts to your People list.

# *microSD Card*

---

Your device is equipped with a 2 GB microSD™ (Secure Digital) memory card that allows you to store images, videos, music, documents, and voice data on your device.

**Important:** Your device comes with the microSD card preinstalled.

[Remove the microSD Card](#)

[Insert a microSD Card](#)

[View the microSD Card Memory](#)

[Format the microSD Card](#)

[Unmount the microSD Card](#)

[Use the Device's microSD Card as a USB Drive](#)

[Use the Device's microSD Card as a Media Device](#)

## *Remove the microSD Card*

Before removing your device's microSD card, use the Storage settings menu to unmount the card.

1. Unmount the microSD card. See [Unmount the microSD Card](#).
2. Remove the battery cover. See [Set Up Your Device](#).
3. Push the card inward slightly and release, causing it to come about halfway out of the slot.

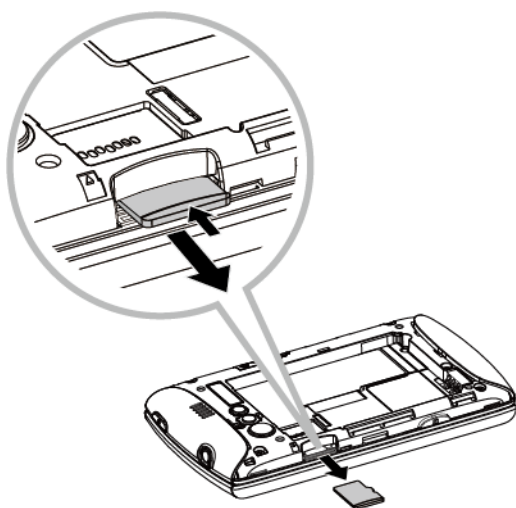



4. Gently remove the card from the slot.
5. Replace the battery cover.

**Note:** You can easily damage the microSD card by improper operation. Please be careful when inserting, removing, or handling the microSD card.

**Note:** Make sure your battery is fully charged before using the microSD card. Your data may become damaged or unusable if the battery runs out while using the microSD card.

## *Insert a microSD Card*

Remove the battery cover and battery to insert a compatible microSD card into your device.

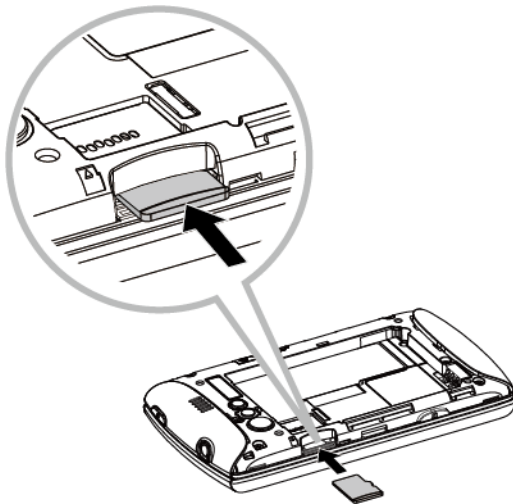

1. Remove the battery cover. See [Set Up Your Device](#).
2. Insert a microSD card into the slot with the gold terminals facing down.
3. Gently press the card in until it snaps into place.



4. Replace the battery cover.



## *View the microSD Card Memory*

The Apps settings menu gives you access to your microSD card memory information.

1. With the microSD card inserted, press **Home**  > **Menu** , and touch **System settings** > **Apps**.
2. Touch **ON SD CARD** tab. The total and available memory space will be displayed at the bottom of the screen.

## *Format the microSD Card*



Formatting a microSD card permanently removes all files stored on the card.

1. Press **Home**  > **Menu** , and touch **System settings** > **Storage**.
2. Scroll down the screen, touch **Erase SD card** > **Erase SD card** > **Erase everything**.

**Note:** The formatting procedure erases all the data on the microSD card, after which the files **CANNOT** be retrieved. To prevent the loss of important data, please check the contents before you format the card.

## *Unmount the microSD Card*

When you need to remove the microSD card, you must unmount the microSD card first to prevent corrupting the data stored on it or damaging the microSD card. Before removing the microSD card, close all running applications on your device and save any data first.

1. Press **Home**  > **Menu** , and touch **System settings** > **Storage**.
2. Touch **Unmount SD card** > **OK**.
3. Remove the microSD card. See [Remove the microSD Card](#).

## *Use the Device's microSD Card as a USB Drive*

To transfer music, pictures, and other files from your computer to your device's microSD card, you need to set the device's microSD card as a USB drive.

1. Connect the device to your computer using the supplied USB cable.
2. If you see  on the status bar, slide it down to open the Notifications panel and touch the USB connection notification.
3. Touch **Mass Storage** > **Done** > **OK**. See [PC Connection](#).
4. On your computer, the connected device is recognized as a removable disk. Navigate to this removable disk and open it.
5. Do one of the following.
  - Copy files from the computer to the root folder on the device's storage card.
  - Copy files from the device's storage card to a folder on your computer or computer desktop.
6. After copying the files, unmount the removable disk (that is, the connected device) as required by your computer's operating system to safely remove your device, and disconnect the device from the computer.

**Note:** The device will not recognize the microSD card when it is connected to a computer as a disk drive. You will not be able to use some of the device's applications such as the **Camera** or **Play Music**.

## *Use the Device's microSD Card as a Media Device*

You can connect your device as a media device to your computer.

1. Connect the device to your computer using the supplied USB cable.
2. If you see  on the status bar, slide it down to open the Notifications panel and touch the USB connection notification.
3. Touch **Media Transfer > Done**. See [PC Connection](#).

# Notes

---

- Instructions to perform tasks in this guide may change depending on the software version on your phone.
- All screens in this guide are simulated. Actual displays may vary.
- Certain mobile phone features are dependent on the capabilities and settings of Virgin Mobile's network. Additionally certain features may not be activated by Virgin Mobile, and/or Virgin Mobile's network settings may limit the feature's functionality. Always contact Virgin Mobile about feature availability and functionality. All features, functionality and other specifications, as well as the information contained in this user guide are based upon the latest available information and are believed to be accurate at the time of issuing. Kyocera Communications, Inc. reserves the right to change or modify any information or specifications without notice or obligation.

# Copyrights

---

© 2012 Kyocera Corporation. All rights reserved. The “Virgin” name and the Virgin signature logo are registered trademarks of Virgin Enterprises Limited and are used under license. All other trademarks are the property of their respective owners. KYOCERA is a registered trademark of Kyocera Corporation.

Android, Google Play, Google Maps, Google Maps Navigation, Gmail, Google Talk, and YouTube are trademarks of Google, Inc.

The *Bluetooth*® word mark and logos are registered trademarks owned by Bluetooth SIG, Inc. and any use of such marks by Kyocera Corporation is under license. Other trademarks and trade names are those of their respective owners.

Swype and the Swype logos are registered trademarks or trademarks of Nuance Communications, Inc. © 2012 Nuance Communications, Inc. All rights reserved.



microSD and microSDHC Logos are trademarks of SD-3C, LLC.



# Index

---

- 411, 7
- Accessory Jack, 10
- Account
  - Google Account, 30
  - Internet Calling, 36
  - Manage, 4
- Airplane Mode, 46
- Android Keyboard
  - Settings, 27
  - User Dictionary, 27
  - Voice Input, 27
- Answer a Call, 38
- Applications, 92
- Auto-rotate Screen, 51
- Back Key, 10
- Battery
  - Charge, 3
  - Install, 2
- Bluetooth, 145
  - Car kit, 146
  - Device Name, 146
  - Disconnect, 147
  - Headset, 146
  - Menu, 145
  - Receive Information, 149
  - Reconnect, 147
  - Send Information, 148
  - Send Photos or Videos, 130
  - Turn on or off, 145
  - Unpair, 147
- Brightness, 50
- Browser, 110
  - Accessibility Settings, 114
  - Advanced Settings, 115
  - Bandwidth Management Settings, 116
  - Bookmarks, 117
  - General Settings, 113
  - Labs Settings, 116
  - Menu, 111
  - Navigate, 110

- Offline Reading, 117
- Open, 109
- Privacy Settings, 113
- Reset, 117
- Search Engine, 116
- Security Settings, 113
- Select Text, 112
- Set the Home Page, 117
- Website Settings, 116
- Calculator, 141
- Calendar, 133
  - Add an Event, 133
  - Erase Events, 137
  - Event Alerts, 135
  - Event Reminders, 135
  - Invite Guests, 134
  - Show or Hide, 138
  - Synchronize, 138
  - View Events, 136
- Call Log, 43
  - Clear, 44
- Call Waiting, 40
- Caller ID, 40
- Camcorder, 122
  - Record, 123
  - Settings, 124
  - Share Videos, 129
  - Viewfinder, 122
- Camera, 119
  - Close, 122
  - Lens, 10
  - Open, 119
  - Review Screen, 121
  - Settings, 124
  - Share Photos, 129
  - Take a Picture, 121
  - Viewfinder, 120
  - Zoom, 126
- Charge Battery, 3
- Charger/Accessory Jack, 10
- Clock & Alarm, 138
  - Change Alarm Settings, 140
  - Open, 138
  - Set an Alarm, 139

- Copyrights, 156
- Credential Storage, 57
- Customer Support, 7
- Data Connection
  - Status and Indicators, 109
- Data Services, 109
- Date & Time, 59
- Device Administration, 57
- Device Layout (illustration), 9
- Drag, 12
- Eco Mode, 143
- Email, 74
  - Send Photos or Videos, 130
- Emergency Call, 35
- Enhanced 911 (E911), 35
- Enter Text, 17
  - Speaking, 23, 27
- Entertainment, 92
- Factory Data Reset, 58
- Favorites Tray, 15
- Folder, 15
- Font Size, 51
- Gallery, 125
  - Close, 127
  - Open, 125
  - View, 126
  - Watch a Video, 127
- Gestures, 12
- Gmail, 72
  - Send Photos or Videos, 130
- Google Account, 30
  - Add, 31
  - Create, 30
  - Settings, 32
  - Sign In, 31
- Google Play, 92
- Google Talk, 87
- Google+, 131
- Home Key, 10
- Home Screen, 13
  - Add Items, 14
  - Customize, 14
  - Move or remove items, 14
- Incoming Calls



- Answer, 38
- Reject, 38
- Internet Calling, 36
- Keyboard
  - Android, 24
  - QWERTY, 17
  - Slide-out, 17
  - Swype, 19
- Keyboard Timeout, 51
- Location
  - Settings, 53
- Menu Key, 10
- Messaging, 72
  - Send Photos or Videos, 130
- microSD Card, 151
  - Format, 152
  - Insert, 152
  - Memory Information, 152
  - Remove, 151
  - Unmount, 153
  - Use as a Media Device, 154
  - Use as a USB Drive, 153
- Mobile ID, 6
  - Install, 6
  - Switch, 7
- Mute
  - Ringtone, 38
- My Location, 53
- Navigation
  - Google Latitude, 98
  - Google Maps, 96
  - Google Navigation, 98
- Notification Icons, 16
- People, 63
- Phone, 33
- Phone Calls
  - From People, 34
  - From Recent Calls, 34
  - From Text Messages, 35
  - In-Call Options, 42
  - Make Calls, 33
  - Plus Code Dialing, 36
  - Receive, 37
  - Using Internet Calling, 36

- Using the Phone Dialpad, 33
  - With Pauses, 36
- Picasa, 131
- Pictures, 119
  - Crop, 129
  - Edit, 128
  - Options Menu, 127
  - Rotate, 128
  - Take, 121
- Pinch and Spread, 13
- Play Music, 101
  - Back Up Downloaded Music Files, 105
  - Playlist, 104
  - Search for Music, 104
- Power Button, 9
- Power On, 11
- Proximity Sensor, 9
- QWERTY Keyboard, 17
- Recent Apps Key, 10
- Recent Calls
  - Options, 43
  - View, 43
- Reject an Incoming Call, 38
- Reset Phone, 59
- Rotate, 13
- Screen Lock
  - With Password, 55
  - With Pattern, 54
  - With PIN, 55
- Screen Proximity Safety, 51
- Screen Timeout, 51
- Set Up
  - Voicemail, 5, 38
  - Your Device, 2
- Settings, 45
  - Android Keyboard, 27
  - Swype, 23
- Silent Mode, 48
- Sleep, 51
- Slide or Flick, 12
- Slide-out Keyboard, 17
- Speaker, 10
- Status Bar, 15
- Status Icons, 16

- Storage
  - Settings, 52
- Swype, 19
  - Settings, 23
  - User Dictionary, 23
  - Voice Input, 23
- Text Entry, 17
  - Copy, 28
  - Paste, 28
  - Speaking, 23, 27
- Tools, 133
- Top-Up, 5
- Touch, 12
- Touch and Hold, 12
- Touchscreen
  - Keyboard, 19
  - Navigation, 12
  - Turn on, 11
- Trademarks, 156
- TTY mode, 41
- Turn Device On, 11
- User Dictionary
  - Android Keyboard, 27
  - Swype, 23
- Video, 122
  - Record, 123
  - Settings, 124
  - Share, 129
  - Watch, 127
- Voice Input
  - Android Keyboard, 27
  - Swype, 23
- Voice Service, 141
  - Automatic Speech Recognition (ASR), 141
  - Text-to-speech Settings, 142
  - Voice Dialer, 141
  - Voice Search, 142
- Vicemail, 38
  - Notification, 39
  - Retrieve Messages, 39
  - Set Up, 5, 38
  - Settings, 39
- Volume, 48
  - Button, 9

- Wallpaper, 15
- Web, 107
- Wi-Fi, 107
  - Check Status, 108
  - Connect to a Different Network, 108
  - Turn On and Connect to a Network, 107
- YouTube, 86, 132