

Kyocera Torque

User Guide



©2013 Sprint. Sprint and the logo are trademarks of Sprint. KYOCERA is a registered trademark of Kyocera Corporation. Other marks are trademarks of their respective owners.

Table of Contents

Table of Contents.....	i
Get Started	1
User Guide Notes	1
Your Phone at a Glance.....	1
Set Up Your Phone.....	2
Insert and Charge the Battery	2
Insert a SIM Card.....	3
Activate Your Phone	5
Set Up Voicemail	5
Sprint Account Information and Help.....	6
Sprint Account Passwords	7
Manage Your Account	7
Sprint Support Services	8
Phone Basics	9
Your Phone’s Layout.....	9
Smart Sonic Receiver	11
Turn Your Phone On and Off	11
Turn Your Screen On and Off	12
Touchscreen Navigation	12
Your Home Screen	16
Home Screen Overview	16
Extended Home Screens	17
Customize the Home Screen	17
Status Bar	19
Enter Text	21
Touchscreen Keyboards	21
Swype.....	21
Swype Settings.....	25
Android Keyboard	26
Android Keyboard Settings	29

Copy and Paste Text	29
Phone Calls	32
Make Phone Calls.....	32
Call Using the Phone Dialpad	32
Call from Call Logs	33
Call from Contacts	33
Call Using a Speed Dial Number	33
Call a Number in a Text Message or Email Message.....	34
Call Emergency Numbers	34
Call Numbers with Pauses.....	35
Call Using the Plus (+) Code.....	35
Call Using Internet Calling	35
Receive Phone Calls.....	36
Visual Voicemail	37
Set Up Visual Voicemail.....	37
Review Visual Voicemail.....	38
Listen to Multiple Voicemail Messages	39
Compose a Message.....	40
Configure Visual Voicemail Settings	40
Change Your Main Greeting via the Voicemail Menu.....	41
Edit the Display Name via the Voicemail Menu.....	41
Voicemail (Traditional)	41
Set Up Voicemail	42
Voicemail Notification	42
Retrieve Your Voicemail Messages	42
Phone Call Options.....	43
In-call Options.....	43
Caller ID	45
Call Waiting	45
3-Way Calling	45
Call Forwarding	46
Set Up Speed Dialing.....	46
Call Logs.....	47

Call Settings	48
TTY Mode.....	49
Sprint Direct Connect	50
About Sprint Direct Connect.....	50
Before Making Your First Direct Connect Call	50
Your Direct Connect Number	50
Dial Direct Connect Numbers	51
Save a Direct Connect Number	51
Display Your Direct Connect Number	52
Make and Answer Direct Connect Calls	52
Make a Direct Connect Call by Entering a Number	52
Make a Direct Connect Call from Contacts	54
Make a Direct Connect Call Using a Speed Dial Number.....	54
Make a Direct Connect Call from Recent DC's	54
Make a Direct Connect Call from the DC Call List.....	55
Availability Notifications	55
Answer Direct Connect Calls	56
End a Direct Connect Call.....	57
Call Alerts	57
Send a Call Alert.....	57
Reply to a Call Alert.....	58
Group Connect	58
Make Group Connect Calls.....	58
Group Connect Call Information.....	60
TeamDC	60
Set Up a TeamDC Group.....	60
Update TeamDC Groups	61
Make a TeamDC Call	61
Remove Yourself from a TeamDC Group	62
TeamDC Call Information	62
Opt-In TeamDC	63
Scan Lock.....	63
Invites	63

Send an Invite.....	63
Reply to an Invite.....	64
Direct Connect Settings	64
Turn Direct Connect On and Off	64
Direct Connect Permissions.....	65
Group Call Options	66
DC Headset Mode	66
One Touch DC.....	66
Beep During a DC Call	67
People	68
Get Started with People	68
Add a Contact	70
Save a Phone Number.....	72
Edit a Contact	72
Add a Group Contact	74
Edit a Group Contact	75
DC Group Contact	75
Add a Group Connect Contact.....	76
Edit a Group Connect Contact	76
ICE (In Case of Emergency)	76
Synchronize Contacts	78
Share a Contact.....	78
Sprint Mobile Sync.....	79
Accounts and Messaging	80
Gmail / Google.....	80
Create a Google Account.....	80
Sign In to Your Google Account.....	81
Access Gmail.....	81
Send a Gmail Message	82
Read and Reply to Gmail Messages.....	82
Email	83
Add an Email Account	83
Add a Corporate Account.....	84

Compose and Send Email	85
View and Reply to Email	85
Manage Your Email Inbox.....	86
General Email Settings	86
Email Account Settings.....	87
Delete an Email Account.....	88
Text Messaging and MMS	88
Compose Text Messages	88
Send a Multimedia Message (MMS)	89
Save and Resume a Draft Message	91
New Messages Notification.....	91
Managing Message Conversations.....	91
Text and MMS Options	93
Social Networking Accounts.....	94
YouTube.....	94
Google Talk	95
Sign In and Chat.....	95
Manage Your Friends	97
Mobile Indicators	98
Sign Out	98
Google Talk Settings	98
Apps and Entertainment.....	100
Google Play Store App	100
Find and Install an App	100
Create a Google Wallet Account.....	101
Request a Refund for a Paid App	102
Open an Installed App	102
Uninstall an App	103
Get Help with Google Play.....	103
Navigation.....	103
Google Maps	103
Scout™ by Telenav	106
Google Navigation	107

Google Latitude	108
Music Player	111
Open the Music Library.....	111
Play Music	111
Search for Music in the Music Library.....	113
Now Playing Queue.....	113
Use Playlists.....	114
Back Up Your Downloaded Music Files	115
Sprint ID.....	115
Install Your ID Pack	116
Switch ID Packs.....	116
Sprint TV & Movies	116
Sprint Zone	117
Web and Data.....	118
Wi-Fi.....	118
Turn Wi-Fi On and Connect to a Wireless Network.....	118
Check the Wireless Network Status.....	119
Connect to a Different Wi-Fi Network.....	119
Sprint Connections Optimizer	119
Sprint 4G	120
Data Services (Sprint 3G and 4G Networks).....	121
Your User Name.....	121
Launch a Web Connection.....	121
Data Connection Status and Indicators.....	122
Virtual Private Networks (VPN)	122
Prepare Your Phone for VPN Connection.....	123
Install Security Certificates.....	123
Add a VPN Connection.....	123
Connect to or Disconnect from a VPN	123
Browser	124
Launch the Web Browser.....	124
Learn to Navigate the Browser	124
Browser Menu	125

Select Text on a Web Page	126
Go to a Specific Website.....	127
Adjust Browser Settings.....	127
Create Website Settings	130
Reset the Browser to Default	130
Set the Browser Home Page	130
Create Bookmarks	131
Create a New Homepage	131
Add Bookmarks to Your Home Screen	132
Portable Wi-Fi Hotspot.....	132
Camera and Video	134
Take Pictures.....	134
Open or Close the Camera	134
Camera Viewfinder Screen	134
Take a Picture	135
Review Screen	136
Record Videos	136
Video Viewfinder Screen.....	136
Record Videos.....	137
Camera Settings	138
Video Camera Settings	139
View Pictures and Videos Using Gallery	140
Open or Close Gallery	140
View Pictures and Videos.....	141
Zoom In or Out on a Picture.....	142
Watch Video	142
Working with Pictures	143
Picture Options Menu	143
Edit a Picture	143
Share Pictures and Videos.....	145
Send Pictures or Videos by Email/Gmail.....	145
Send Pictures or Videos by Multimedia Message	145
Send Pictures or Videos Using Bluetooth	146

Share Pictures and Videos on Google+	146
Share Pictures on Picasa.....	146
Share Videos on YouTube.....	147
Tools and Calendar.....	148
Calendar	148
Add an Event to the Calendar	148
Invite Guests to Your Calendar Event (Google Account Only)	149
Calendar Event Alerts.....	149
View Calendar Events	150
Erase Calendar Events.....	152
Show or Hide Calendars.....	153
Synchronize Calendars with Your Phone.....	153
Clock	153
Open Clock.....	153
Alarm.....	154
Calculator	156
LED Flashlight	156
Voice Services.....	156
Automatic Speech Recognition (ASR)	157
Text-to-Speech Settings	158
Voice Search	158
Eco Mode	159
Bluetooth	159
Turn Bluetooth On or Off.....	159
The Bluetooth Settings Menu.....	160
Change the Device Name.....	160
Connect a Bluetooth Headset or Car Kit	160
Reconnect a Headset or Car Kit	161
Disconnect or Unpair from a Bluetooth Device.....	161
Send and Receive Information Using Bluetooth.....	162
Near Field Communication (NFC) Technology.....	164
Turn NFC On or Off	164
Android Beam.....	164

microSD Card	165
Insert a microSD Card	165
Remove the microSD Card	166
View the microSD Card Memory	167
Format the microSD Card	167
Unmount the microSD Card	167
Use the Phone's microSD Card as a USB Drive	167
Use the Phone's microSD Card as a Media Device	168
Update Your Phone	168
Update Your PRL	168
Update Your Profile	169
Update Your Phone Firmware	169
Update Kyocera Software	170
Sprint Worldwide Wireless Service.....	171
Activate Sprint Worldwide Service on Your Account	171
Enable Global Roaming Mode	171
Make and Receive Worldwide Calls	172
Sprint Voicemail Service	173
Set Up Your Voicemail Access Number	173
Access Your Voicemail	173
Voicemail Troubleshooting.....	174
International Data Roaming	174
Status Messages	174
Contact Sprint for Assistance	175
Settings.....	177
Wi-Fi Settings	177
Bluetooth Settings.....	178
MaxiMZR Settings	178
Data Usage Settings	178
More Settings.....	180
Airplane Mode	180
VPN Settings	180
Tethering & Portable Hotspot Settings.....	180

NFC Settings	180
Wi-Fi Direct Settings	180
Mobile Networks Settings	181
Roaming Settings	181
Roaming Guard	183
Direct Connect Settings	184
Sound Settings	184
Volumes	184
Silent Mode.....	184
DC Calls Sound	185
Call Alerts Sound	185
Phone Ringtone.....	185
Vibrate Pattern.....	185
Default Notification.....	185
Vibrate and Ring	186
Persistent Alerts	186
Dial Pad Touch Tones	186
Touch Sounds	186
Screen Lock Sound	186
Vibrate on Touch	187
Hearing Aid.....	187
Display Settings	187
Brightness	187
Wallpaper	187
Auto-Rotate Screen	188
Sleep	188
Font Size	188
Key Backlight.....	188
Screen Proximity Safety.....	188
Storage Settings	189
Battery Settings	189
PC Connection Settings.....	190
Apps Settings.....	190

Accounts & Sync Settings.....	191
Location Services Settings.....	191
Security Settings.....	192
Screen Lock.....	192
Automatically Lock.....	194
Power Button Instantly Locks.....	194
Vibrate on Touch	194
Owner Information	194
Encryption	195
Set Up SIM Card Lock.....	195
Make Passwords Visible	195
Device Administrators.....	196
Unknown Sources.....	196
Credential Storage.....	196
Language & Input Settings.....	197
Language Settings.....	197
Pointer Speed.....	197
Back Up and Reset Phone Settings	197
Date & Time Settings	198
Accessibility Settings	199
Services.....	199
Large Text	199
Power Button Ends Call.....	199
Auto-Rotate Screen	199
Speak Passwords.....	200
Explore by Touch.....	200
Touch & Hold Delay.....	200
Install Web Scripts.....	200
DC Button.....	200
Developer Options Settings	201
Activate This Device	201
About Phone.....	201
System Update	201

Copyright Information.....	202
Index.....	203

Get Started

The following topics give you all the information you need to set up your phone and Sprint service the first time.

User Guide Notes

Instructions to perform tasks in this guide may change depending on the software version on your phone.

All screens in this guide are simulated. Actual displays may vary.

Your Phone at a Glance

The following illustration outlines your phone's primary external features and buttons.



Set Up Your Phone

You must first install and charge the battery to begin setting up your phone.

Insert and Charge the Battery

Follow the steps below to insert the battery and charge it.

1. Install the battery.

- Turn the battery cover lock counter-clockwise to the unlocked position.

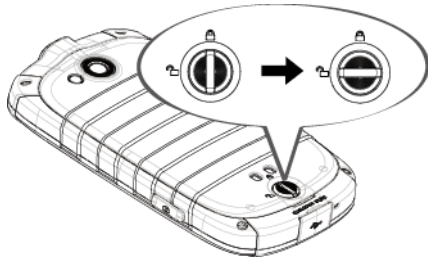

- Insert your thumb- or fingernail into the slot and lift the battery cover gently.

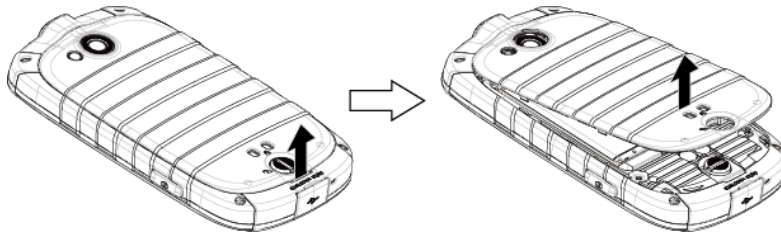

- Insert the battery, contacts end first, and gently press the battery into place.

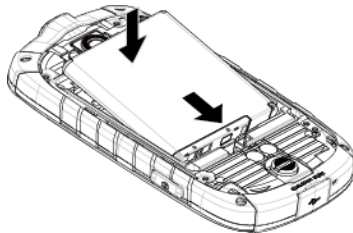

- Replace the battery cover, making sure all the tabs are secure and there are no gaps around the cover.

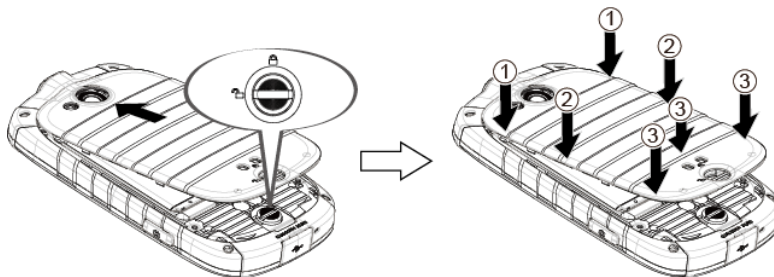

- Turn the battery cover lock clockwise to the locked position.

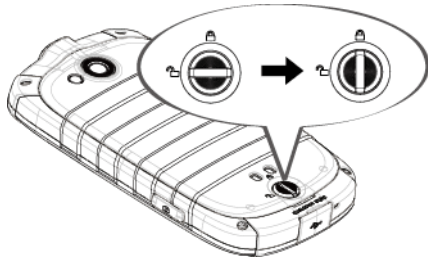

Note: When you insert the battery, your phone may power on automatically.

2. Charge your battery.

- Open the cover of the charger/accessory jack.
- Plug the smaller end of the USB cable into the phone's charger/accessory jack.

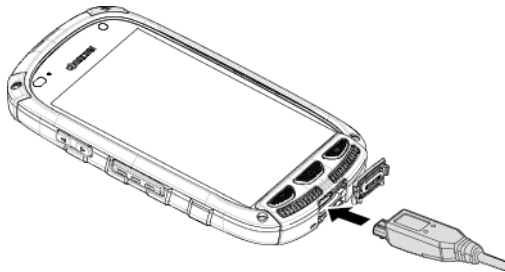

- Plug the other end of the USB cable into the charger, and then plug the charger into an electrical outlet.

Note: Your phone's battery should have enough charge for the phone to turn on and find a signal, set up voicemail, and make a call. You should fully charge the battery as soon as possible.

3. Press and hold the **Power** button to turn the phone on.

- If your phone is activated, it will turn on and search for Sprint service.
- If your phone is not yet activated, see [Activate Your Phone](#) for more information.

Insert a SIM Card

Your phone comes with a preinstalled SIM (Subscriber Identity Module) card.

Note: Your SIM card should be preinstalled. If you need to reinstall your SIM card, follow the instructions below.

Note: The SIM included contains information specific to your phone and should be retained with the phone.

1. Remove the battery cover. See [Insert and Charge the Battery](#).

2. Lift the battery and remove it.

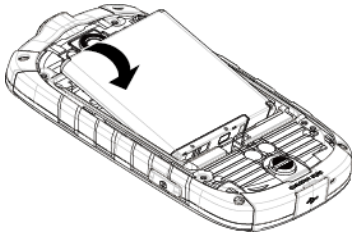

3. Slide the flap of the SIM card holder in the direction of the arrow to unlock it and lift the flap.

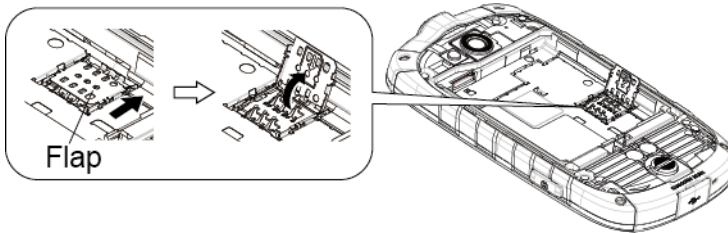

4. Hold the SIM card so that the metal contacts on the SIM card face down and the cut off corner points to the bottom-left corner of your phone. Insert the SIM card into the flap of the SIM card holder.

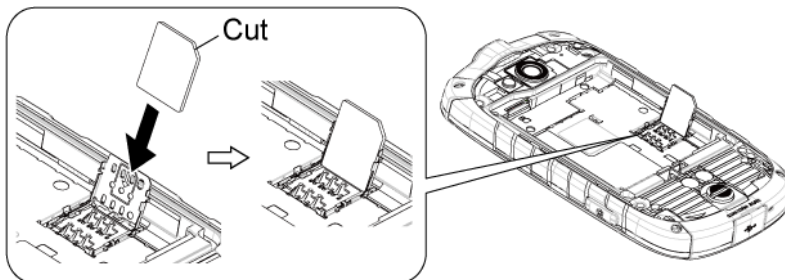

5. Replace the flap of the SIM card holder and slide the flap in the direction of the arrow to lock it.

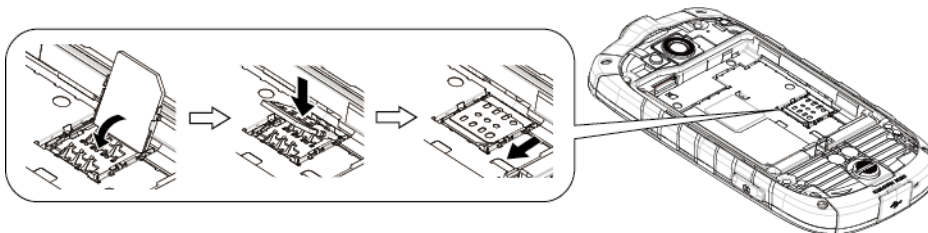

6. Replace the battery and the battery cover. See [Insert and Charge the Battery](#).

Activate Your Phone

Follow the instructions below to activate your phone if it has not already been activated. Depending on your account or how and where you purchased your phone, it may be ready to use or you may need to activate it on your Sprint account.

- If you purchased your phone at a Sprint Store, it is probably activated and ready to use.
- If you received your phone in the mail and it is for a new Sprint account or a new line of service, it is designed to activate automatically.
 - When you turn the phone on for the first time, you should see a **Hands Free Activation** screen, which may be followed by a **PRL Update** screen and a **Firmware Update** screen. Follow the onscreen instructions to continue.
- If you received your phone in the mail and you are activating a new phone for an existing number on your account (you're swapping phones), you can activate on your computer online or directly on your phone.
 - **Activate on your computer:**
 - Go to sprint.com/activate and complete the online instructions to activate your phone.
 - **Activate on your phone:**
 - Turn on your new phone. (Make sure the old one is turned off.) Your phone will automatically attempt Hands-Free Activation.
 - If an error occurs, touch **Activate** to override auto-activation and start the manual activation wizard.
 - Follow the on-screen prompts to complete the activation process.

To confirm activation, make a phone call. If your phone is still not activated or you do not have access to the Internet, contact Sprint Customer Service at **1-888-211-4727** for assistance.

Tip: Do not press the **Power** button while the phone is being activated. Pressing the **Power** button cancels the activation process.



Note: If you are having any difficulty with activation, contact Sprint Customer Service by calling **1-888-211-4727** from any other phone.

Set Up Voicemail





You should set up your Voicemail and personal greeting as soon as your phone is activated. Always use a password to protect against unauthorized access. Your phone automatically transfers all unanswered calls to your voicemail, even if your phone is in use or turned off.

Note: Voicemail Password – Sprint strongly recommends that you create a password when setting up your voicemail to protect against unauthorized access. Without a password, anyone who has access to your phone is able to access your voicemail messages.

To set up visual voicemail:

1. Press **Home**  >  > **Voicemail**. (If your screen is locked, press the **Power** button to turn on the display and then flick  to unlock the screen.)
2. Touch **Personalize now** and follow the system prompts to:
 - Create a password (part of standard voicemail).
 - Record your name announcement.
 - Record your greeting.
3. When prompted to enter information, touch **Dialpad** to bring up the onscreen dialpad to enter your numeric responses.
4. Once you have completed the setup process, return to the voicemail page (see step 1).
5. Touch the **Welcome to Voicemail** message on the screen to play a brief explanation of the voicemail services.

To set up traditional voicemail:

1. Press **Home**  >  > . (If your screen is locked, press the **Power** button to turn on the display and then flick  to unlock the screen.)
2. Touch and hold  to dial your voicemail number.
3. Follow the system prompts to:
 - Create your password.
 - Record your name announcement.
 - Record your greeting.

For more information about voicemail, see [Voicemail \(Traditional\)](#) or [Visual Voicemail](#).

Sprint Account Information and Help

Find out about account passwords and information about managing your account and finding help.

Sprint Account Passwords

You will need to create passwords to protect access to your personal account information, your voicemail account, and your data services account. As a Sprint customer, you enjoy unlimited access to all of your information.

Account User Name and Password

If you are the account owner, you will create an account user name and password when you sign on to sprint.com. (Click **Sign in/Register** and then click **Sign up now!** to get started.) If you are not the account owner (if someone else receives the bill for your Sprint service), you can get a sub-account password at sprint.com.

Voicemail Password

You'll create your voicemail password when you set up your voicemail. See [Set Up Voicemail](#) for more information on your voicemail password.

Data Services Password

With your Sprint phone, you may elect to set up an optional data services password to control access and authorize purchases.

For more information, or to change your passwords, sign on to sprint.com or call Sprint Customer Service at **1-888-211-4727**.













Manage Your Account

Manage your Sprint account from your computer, your Sprint phone, or any other phone.

Online: sprint.com

- Access your account information.
- Check your minutes used (depending on your Sprint service plan).
- View and pay your bill.
- Enroll in Sprint online billing and automatic payment.
- Purchase accessories.
- Shop for the latest Sprint phones.
- View available Sprint service plans and options.
- Learn more about data services and other products like games, ringtones, screen savers, and more.

From Your Sprint Phone

1. Press **Home**  >  > .
2. Do any of the following:
 - Touch    to check minute usage and account balance.
 - Touch    to make a payment.
 - Touch    to access the Sprint Zone, where you can check your account, update your phone, watch video tutorials, or contact Sprint Customer Service.

From Any Other Phone

- Sprint Customer Service: **1-888-211-4727**.
- Business Customer Service: **1-888-788-4727**.

Sprint Support Services

Sprint 411 and Sprint Operator Services let you easily access information and calling assistance from your Sprint phone.

Sprint 411

Sprint 411 gives you access to a variety of services and information, including residential, business, and government listings, movie listings or showtimes, driving directions, restaurant reservations, and major local event information. You can get up to three pieces of information per call, and the operator can automatically connect your call at no additional charge.

There is a per-call charge to use Sprint 411, and you will be billed for airtime.

- ▶ Press **Home**  >  > , and then touch    .

Sprint Operator Services

Sprint Operator Services provides assistance when you place collect calls or when you place calls billed to a local telephone calling card or third party.

- ▶ Press **Home**  >  > , and then touch  .

For more information or to see the latest in products and services, visit us online at sprint.com.

Phone Basics

Your phone is packed with features that simplify your life and expand your ability to stay connected to the people and information that are important to you. The following topics will introduce the basic functions and features of your phone.



Your Phone's Layout

The illustrations and descriptions below outline your phone's basic layout.



Key Functions

- **Smart Sonic Receiver (Internal)** lets you hear the caller and automated prompts. See [Smart Sonic Receiver](#).

- **Proximity Sensor/Light Sensor** detects how close an object is to the surface of the screen. This is typically used to detect when your face is pressed up against the screen, such as during a phone call. It also automatically turns off the keyboard backlight and brightens the display when you are in sunlight or a bright room, and turns on the keyboard backlight and dims the display in darker places.
- **LED Indicator** displays a phone notification, charging status, or alert.
- **Home Key**  returns you to the home screen. Press and hold to open the recently-used applications window.
- **Back Key**  lets you return to the previous screen, or close a dialog box, options menu, the Notifications panel, or onscreen keyboard.
- **Speakers** let you hear the different ringtones and sounds. The speakers also let you hear the caller's voice in speakerphone mode.
- **Menu Key**  lets you open the menus of the current screen or application.
- **Self Camera Lens** takes pictures and records videos while facing the screen, and allows you to video conference.
- **Touchscreen** displays all the information needed to operate your phone. Use finger gestures to navigate and interact with items on the screen.
- **Power Button** lets you turn the phone on or off or turn the screen on or off, or switch your phone to silent mode, vibration mode, or airplane mode.
- **Headset Jack** allows you to plug in an optional headset for convenient, hands-free conversations.
- **Speaker Button** lets you place or receive calls in speakerphone mode or turn the speakerphone on and off during a call.
- **Microphones** transmit your voice for phone calls or record your voice or ambient sounds for voice recordings and videos.
- **Charger/Accessory Jack** allows you to connect the micro-USB cable (included) to charge the battery or to transfer files to and from a computer.
- **Volume Button** allows you to adjust the ringtone or media volume when you are not on a call, or adjust the voice volume during a call.
- **Direct Connect Button (DC Button)** allows you to make Direct Connect calls, send Call Alerts, and view Direct Connect Call logs.
- **Camera Button** lets you activate the camera and video camera, and take pictures and videos.

- **Internal Antennas** facilitate reception and transmission. To maximize performance, do not obstruct while using the phone.
- **Battery Cover Lock** turns to lock and unlock the battery cover.
- **Power Connectors** allow your phone to be connected to an optional multi-bay charger.
- **SIM Card Slot (Internal)** allows you to insert a SIM card.

Note: Your phone comes with the SIM card preinstalled.

- **microSD Card Slot (Internal)** allows you to insert an optional microSD card to support external memory.
- **Back Camera Lens** lets you take pictures and videos.
- **Camera Flash** helps illuminate subjects in low-light environments when taking a picture or recording a video. It can also work as an LED flashlight. See [LED Flashlight](#).

CAUTION! Inserting an accessory into the incorrect jack may damage the phone.

Smart Sonic Receiver

Smart Sonic receiver transmits sound through vibrations on your phone's display screen. Place your ear around the internal receiver and adjust the position of the phone to find the best hearing point depending on the surrounding environment.

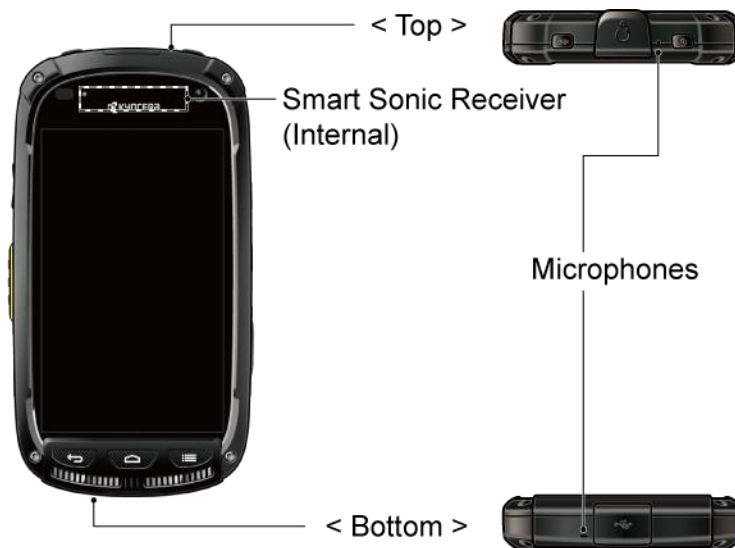

Note: Do not cover the microphones during a call. Do not apply any sheet or sticker to the display area as it may compromise the hearing quality.

Turn Your Phone On and Off

The instructions below explain how to turn your phone on and off.

Turn Your Phone On

- ▶ Press and hold the **Power** button.

Turn Your Phone Off

1. Press and hold the **Power** button to open the phone options menu.
2. Touch **Power off** > **OK** to turn the phone off.

Your screen remains blank while your phone is off.

Restart Your Phone

- ▶ Press and hold the **Power** button and touch **Restart** > **OK**.

The phone will shut down and power on again.

Turn Your Screen On and Off

Your phone allows you to quickly turn the screen off when not in use and to turn it back on and unlock it when you need it.

Turn the Screen Off When Not in Use

- ▶ To quickly turn the screen off, press the **Power** button. Pressing the **Power** button again or receiving an incoming call will turn on your phone screen and show the lock screen.

To save battery power, the phone automatically turns off the screen after a certain period of time when you leave it idle. You will still be able to receive messages and calls while the phone's screen is off.

Note: For information on how to adjust the time before the screen turns off, see [Sleep](#).

Turn the Screen On and Unlock It

1. To turn the screen on, press the **Power** button.
2. Flick  to unlock the screen.
 - You can disable the screen lock or enable a more secure one from the Settings menu. See [Screen Lock](#).

Touchscreen Navigation

Your phone's touchscreen lets you control actions through a variety of touch gestures.

Touch

Touch the screen with your finger to select or launch a menu, option, or application. A light touch works best.



Touch and Hold

To open the available options for an item (for example, a keyboard), touch and hold the item.

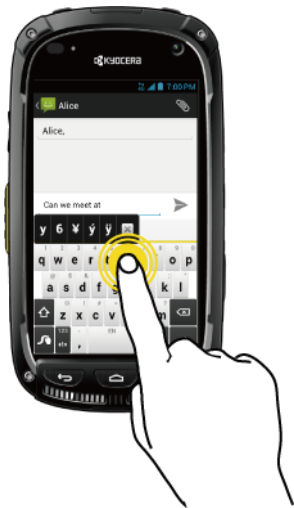

Drag

Touch and hold your finger before you start to move it. Do not release your finger until you have reached the target position.



Swipe or Slide

To swipe or slide means to quickly drag your finger vertically or horizontally across the screen.



Flick

Flicking the screen is similar to swiping, except that you need to swipe your finger in light, quick strokes.



Pinch and Spread

Pinch the screen using your thumb and forefinger to zoom out, or spread the screen to zoom in when viewing a picture or a Web page. (Move fingers inward to zoom out and outward to zoom in.)



Rotate

For most screens, you can automatically change the screen orientation from portrait to landscape by turning the phone sideways. When entering text, you can turn the phone sideways to bring up a bigger keyboard. See [Touchscreen Keyboards](#) for more details.



Note: The **Auto-rotate screen** check box needs to be selected for the screen orientation to automatically change. Press **Home**  > **Menu**  > **System settings** > **Display** > **Auto-rotate screen**.

Your Home Screen

The home screen is the starting point for your phone's applications, functions, and menus. You can customize your home screen by adding application icons, shortcuts, folders, widgets, and more.

Home Screen Overview

Your home screen extends beyond the initial screen. Swipe the screen left or right to display additional screens.

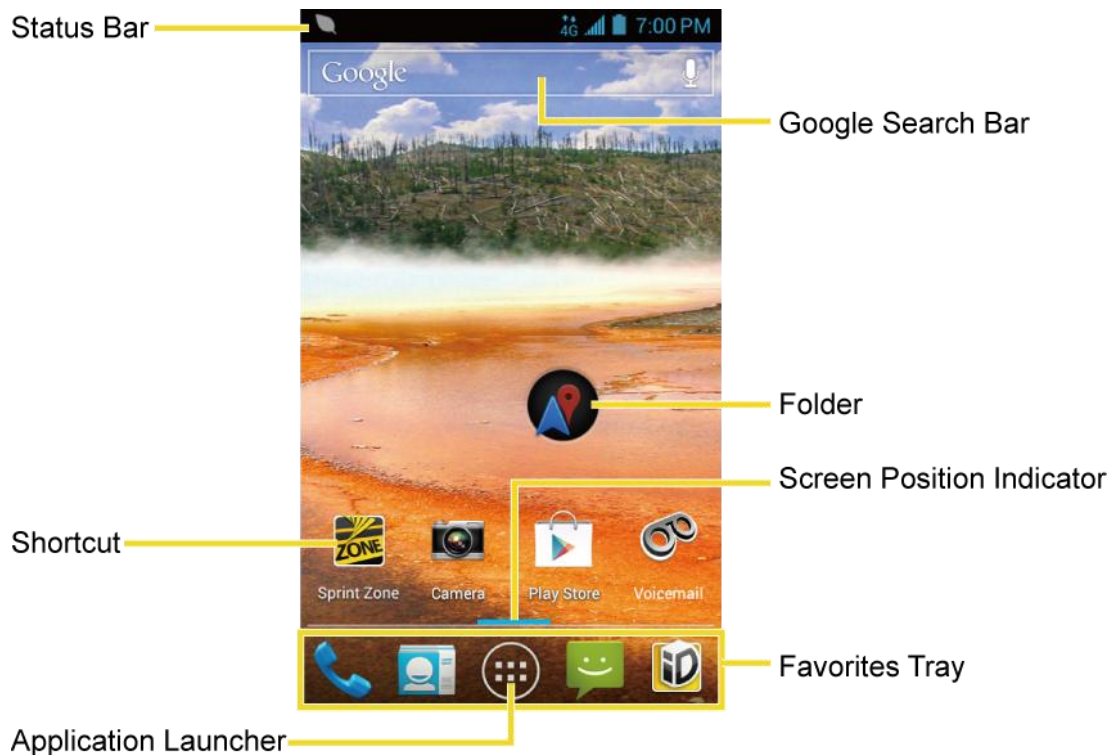

- **Status Bar:** Displays the time, notification, and phone status icons. Slide down to display the Notifications panel.
- **Shortcut:** Allows users to quickly launch applications.

- **Application Launcher:** Touch to display available applications and widgets on the phone.
- **Favorites Tray:** Contains up to five icons and appears on every home screen. You can customize these icons except the application launcher icon in the middle.
- **Screen Position Indicator:** Indicates where you are among the five home screens.
- **Folder:** Allows users to organize screen items. You can store multiple application icons as a group.
- **Google Search Bar:** Allows users to enter text or spoken keywords for a quick search on the phone or on the Internet. Touch to enter text or touch  to speak your keyword.

Tip: Press **Home**  to return to the main home screen from any other screen.

Extended Home Screens

In addition to the main home screen, your phone has four extended home screens to provide more space for adding icons, widgets, and more. Press **Home**  and then drag across the screen to move from the main screen to an extended screen.

- You cannot add more screens.
- While on an extended screen, press **Home**  to return to the main home screen.



Customize the Home Screen

Learn how to add, move, or remove items from the home screen.

Add App Shortcuts or Widgets to the Home Screen

1. Touch  on the favorites tray.
2. Slide the **APPS** or **WIDGETS** screens to find the item you want to add to the home screen.
3. Touch and hold the app icon or a widget and move your finger to find the place to add it to. The blue frames which appear on the screen indicate where you might place the item.
4. Release your finger.

Move or Remove Items on the Home Screen

- ▶ Touch and hold the item you want to move or remove from the home screen.
 - To move the item, drag it to a new area and release it.
 - To remove the item, drag it to “**X Remove**” at the top of the screen and release it when it turns red.

Favorites Tray

The favorites tray takes up to five icons and appears on every home screen. You can replace those icons except the application launcher icon in the center of the tray.

To add a new icon to the favorites tray:

1. Remove the current icon on the tray. See [Move or Remove Items on the Home Screen](#).
2. Touch and hold an app icon and drag it to the favorites tray.
3. Release your finger.

Use Folders

You can place several app icons in a folder. Drop an app icon over another on the home screen, and the two icons will be in the same folder.

1. Touch and hold an app icon and drag it over another on the home screen.
2. Release your finger. You can see two icons piled within a folder (a black circle).
3. Touch the circle. You can see the app icons within the folder.
4. Touch **Unnamed Folder**. The keyboard opens and you can name the folder. To rename it, touch the name.

Change Wallpaper









1. Touch and hold an empty area on a home screen.
2. Select one of the following options:
 - **Gallery:** Select to use saved or captured pictures on your phone. Touch to select a picture and crop it before setting it as wallpaper.
 - **ID wallpapers:** Select to use ID wallpapers. Select the wallpaper and touch **Set wallpaper**.
 - **Live Wallpapers:** Select to use Live wallpapers. Select the wallpaper and touch **Set wallpaper**.
 - **Wallpapers:** Select to use preset wallpapers. Select the wallpaper and touch **Set wallpaper**.









Status Bar

The status bar at the top of the home screen provides phone and service status information on the right side and notification alerts on the left. To view notification alerts, touch the status bar and drag it down.

Status Icons















Icon	Status
	Bluetooth® enabled
	Wi-Fi® active (full signal)
	Vibrate
	Silent
	Network (full signal)
	Network (roaming, full signal)
	Network (no signal)
	3G (data service)
	4G (data service)

Icon	Status
	Airplane mode
	Alarm set
	Battery (charging)
	Battery (full charge)
	Battery (discharged)
	DC Unavailable
	DC Off
	DC Speaker On
	DC Speaker Off

Notification Icons



Icon	Notification
	Missed call
	New email
	New Gmail
	New SMS message
	New MMS message
	Event
	Music application is running background
	USB connection
	Alarm
	When animating, GPS is active

Icon	Notification
	Downloading
	Call Alert, Missed Call Alert
	DC call, Invite, Availability Notification, GLMS, Missed DC call

Enter Text

You can type on your phone using one of the available touchscreen keyboards.

Touchscreen Keyboards



Your phone offers you a choice of two touchscreen keyboards for entering text. The keyboard appears automatically onscreen when you touch a text entry field, and they can be used in either portrait or landscape mode.

The methods available include:

- **Swype** lets you enter letters and words in one continuous motion by swiping your finger across the letters. See [Swype](#) for details.
- **Android keyboard** lets you use a traditional QWERTY setup to enter text. Additional options expand your ability to enter text faster and more accurately. See [Android Keyboard](#) for details.

Note: Swype is selected as a default keyboard.

To select a keyboard from Settings:

1. Press **Home**  > **Menu**  > **System settings** > **Language & input** > **Default**.
2. Touch **Swype** or **Android keyboard**.

To switch the keyboard when a keyboard is displayed:

1. Drag the Notifications panel down and touch **Select input method**.
2. Touch **Swype** or **Android keyboard**.

Swype

The Swype™ keyboard lets you enter words by drawing a path from letter to letter in one continuous motion.

Swipe Keyboard Overview

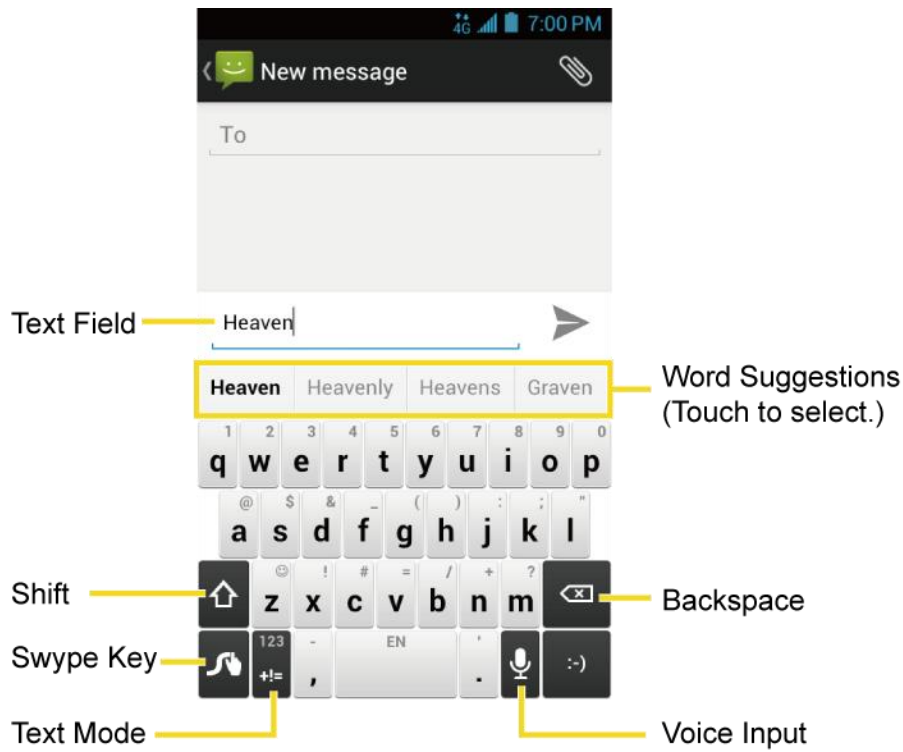

Note: Key appearance may vary depending on the selected application or text field.

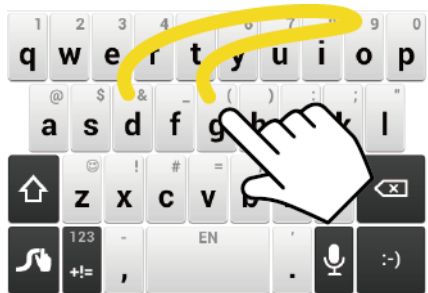

Example: dog
Place your finger on the key with the first letter of the word and glide to the following letters. Lift your finger after the last letter.











Example: cool
For double letters, circle the letter.

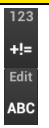

Example: You
To capitalize the letter, slide
up over the keyboard.



Tip: For tips on using Swype, touch and hold the Swype key  and then touch **How to Swype**.

Some of the keys on the Swype keyboard are given below:

Key	Description
	Text mode: Touch to toggle between the Alphabet keyboard and Number & Symbol keyboard.
	Swype: Touch and hold to access the tips or the settings of Swype.
	Voice input mode: Touch to enter text using your voice.
	Backspace: Touch to delete a character. Touch and hold to delete multiple characters.
	Smiley: Touch to insert a smiley. Touch and hold to view and select other smileys.
	Space: Touch to insert a space. The letters on the key show the keyboard's language. Touch and hold to bring up the Languages screen to select another language.
	Enter: Touch to confirm your entry or move to a new line.
	Shift: Touch to toggle between the lowercase, uppercase, and caps lock text input.

Text Mode

ABC mode is primarily used for entering letters while Number & Symbol mode for numbers and symbols.

Touch  to select ABC mode. Touch  to select Number & Symbol mode.

- In ABC mode, touch  to alter the capitalization:

 (Unshifted) to enter all letters in a word lowercase.

 (One-character-shifted) to capitalize only the first letter of a word.

 (Caps Lock) to enter all letters in a word uppercase.

- The Number & Symbol keyboards are in two layers. Touch  to display the second keyboard.
- Some keys have alternate characters. In either mode, if a key displays an extra character on the upper right corner, touch and hold the key to enter the character. Or, touch and long hold a key to call up a list of all the characters available on that key. Touch the character you want to enter from the list.



Swype Voice Input

You can use voice input to enter text by speaking anywhere that you can enter text with the touchscreen keyboard.

1. Touch  on the keyboard.
2. Say the text you wish to enter into the microphone.

Swype User Dictionary



To add a word to your Swype dictionary:



1. Enter a word on the Swype keyboard by touching each letter without sliding your finger.
2. Touch . The word is highlighted.
3. Touch  again.
4. Touch **Add “xxx” to dictionary**.

To delete a word in your Swype dictionary:

1. Touch and hold  on the Swype keyboard.



– or –

Press **Home**  > **Menu**  > **System settings** > **Language & input**, and then touch  next to **Swype**.

2. Touch **Personalization > Edit Dictionary**.
3. Touch a word to select it. You can touch  to select all the words in the dictionary.
4. Touch  > **OK**.

Swype Settings

You can customize the Swype settings as you like.

1. Press **Home**  > **Menu**  > **System settings > Language & input**.
2. Touch  next to **Swype**.

Tip: You can open the Swype settings from the Swype keyboard. Touch and hold  on the keyboard.

3. Choose from the following options:
 - **How to Swype:** Touch to learn Swype in quick steps.
 - **Gestures:** Touch to learn some useful shortcuts on the Swype keyboard.
 - **Preferences:** Touch to show the following settings menus for Swype.
 - **Vibrate on keypress:** Select to activate vibration when a key is touched.
 - **Sound on keypress:** Select to play tones when a key is touched.
 - **Auto-correction:** Select to automatically correct mistyped words.
 - **Show helpful tips:** Select to display helpful tips for using Swype.
 - **Auto-spacing:** Select to automatically insert spaces between words.
 - **Auto-capitalization:** Select to automatically capitalize the first letter of sentence-initial words where available.
 - **Show complete trace:** Select to display the complete Swype path.
 - **Pop-up on keypress:** Select to display a larger image of the key above it when you touch it.
 - **Next word prediction:** Select to predict words based on the previously entered text.
 - **Enable handwriting:** Select to enable the handwriting function.
 - **Reset Swype's dictionary:** Select to delete all the words you have added to Swype's dictionary.

- **Version:** Touch to display the current Swype version.
- **Language Options:** Touch to select the language to use on Swype.
- **Swype Connect:** Touch to use a background service which collects Swype-specific data and utilizes it to improve your Swype experience.
- **Personalization:** Touch to personalize Swype to your taste, including changing the keyboard theme and editing the dictionary.
- **Updates:** Touch to perform an update.

For more information about Swype, visit swype.com.

Android Keyboard

The Android keyboard offers a traditional QWERTY keyboard setup for entering text by touching keys (like on a computer), along with enhancements and options that allow you to enter text faster and more accurately, such as continuous key input, personalized usage dictionaries, and more.

Android Keyboard Overview

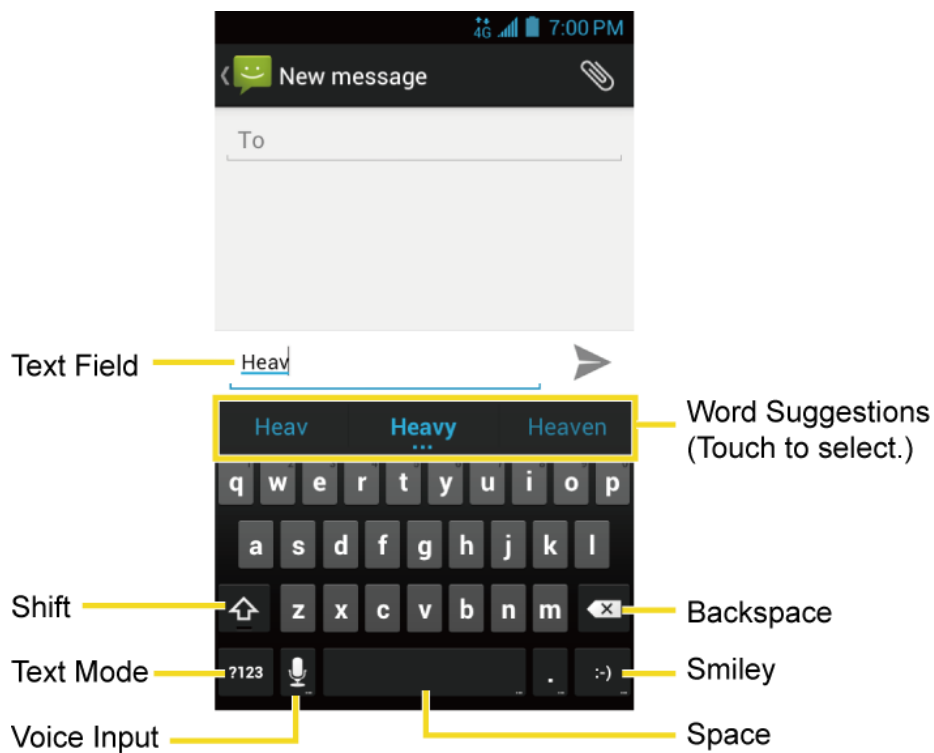

Note: Key appearance may vary depending on the selected application or text field.







Some of the keys on the Android keyboard are given below:

Key	Description
	Shift: Touch to toggle between lower case and upper case.
	Caps lock: Double-touch the lower case or upper case shift key.
	Text mode: Touch to toggle between the Alphabet keyboard and Number & Symbol keyboard.
	Voice input mode: Touch to enter text using your voice.
	Backspace: Touch to delete a character. Touch and hold to delete multiple characters.
	Smiley: Touch to insert a smiley. Touch and hold to view and select other smileys.
	Next: Touch to go to the next text entry field.
	Alternate: Touch to toggle between the default Number & Symbol keyboard and additional Number & Symbol keyboard.
	Go: Touch to go to a Web address.
	Space: Touch to insert a space. Touch and hold to select the input method.

Text Mode

ABC mode is primarily used for entering letters while Number & Symbol mode for numbers and symbols.

Touch  to select ABC mode. Touch  to select Number & Symbol mode.

- In ABC mode, touch  to alter the capitalization:
 -  (Unshifted) to enter all letters in a word lowercase.
 -  (One-character-shifted) to capitalize only the first letter of a word.
- You can select the caps lock by double-touching  or  to make all letters in a word uppercase.
 -  (Caps Lock) to enter all letters in a word uppercase.
- In Number & Symbol mode, touch  to display more symbols.





- Some keys have alternate characters. In either mode, if a key displays an extra character at the upper right corner, touch and hold the key to enter the character. Or, touch and long hold a key to call up a list of all the characters available on that key. Touch the character you want to enter from the list.

Google Voice Typing

Google Voice typing uses Google voice recognition to convert speech to text. You need a data or Wi-Fi connection to use this feature.

If the Android keyboard does not display the microphone icon , the voice input feature is not enabled.

To enable the voice input feature:



1. Press **Home**  > **Menu**  > **System settings** > **Language & input**.
2. Select the **Google voice typing** check box if it is not selected.
3. Touch  next to **Android keyboard**.
4. Touch **Voice input key** and select **On main keyboard** or **On symbols keyboard**. The microphone icon  appears on the specified keyboard.

To enter text by speaking:

1. Touch the microphone icon  on the keyboard.
2. Say the text you wish to enter into the microphone and touch **Done**.

Add a Word to the User Dictionary



You can use the user dictionary option to add new words to the dictionary.

1. Press **Home**  > **Menu**  > **System settings** > **Language & input**.
2. Touch **Personal dictionaries**.
3. Select a language.
4. Touch .
5. Type the word you want to add and touch **OK**. (A list of words you have added to the dictionary is displayed.)
 - Touch a word to edit it.

- Touch  to delete it.

Android Keyboard Settings

You can customize the Android keyboard settings as you like.

1. Press **Home**  > **Menu**  > **System settings** > **Language & input**.
2. Touch  next to **Android keyboard**.

Tip: When **Show settings key** is enabled in the Android keyboard settings, touch  on the Android keyboard and touch **Android keyboard settings**. When the setting is disabled, touch and hold the key to the immediate left of the space key on the Android keyboard and touch **Android keyboard settings**.

3. Choose from the following options.
 - **Input languages:** Touch to select the input language. The dictionary for the selected language will be enabled.
 - **Auto-capitalization:** Check to automatically set the first letter of a sentence to upper case.
 - **Vibrate on keypress:** Check to activate vibration when a key is touched.
 - **Sound on keypress:** Check to activate a clicking sound when a key is touched.
 - **Popup on keypress:** Check to display a larger image of the key above it when you touch it.
 - **Show settings key:** Check to display the keyboard settings key on the keyboard.
 - **Voice input key:** Touch to select where the Voice Input key is displayed from **On main keyboard**, **On symbols keyboard**, or **Off**.
 - **Add-on dictionaries:** Touch to select the dictionary you want to use.
 - **Auto correction:** Touch to allow the space bar and punctuation to automatically correct mistyped words.
 - **Show correction suggestions:** Touch to select when correction suggestions are displayed.
 - **Advanced settings:** Touch to open the settings for expert users.

Copy and Paste Text

In applications that require text entry, such as Messaging, use the copy and paste functions to copy and paste text from one application to another.

To copy and paste the text:

1. Open the application or received message that you want to copy text from.
2. Touch and hold the text body. Selection tabs appear and the currently selected words or characters are highlighted. Drag the tabs to expand or reduce the range of the selected text.

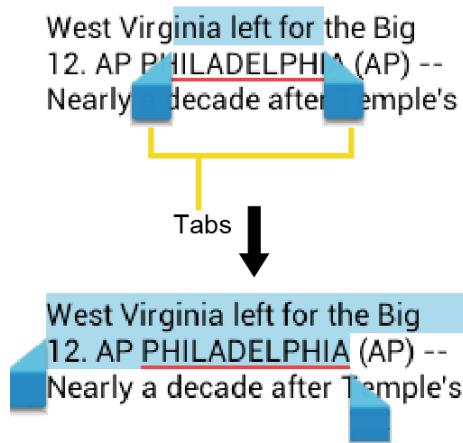

Tip: Touch  or **SELECT ALL** to select all the text on the Web page.

3. Touch  to copy the selected text.
4. Open the application that you want to paste the text to.
5. Touch and hold the text box where you want to paste the text to, and touch **PASTE**.
 - If you want to add the selected text to the current text, place a cursor to the position where you want to insert the selected words or characters. Touch and hold the text box, and touch **PASTE**.

To copy text from a Web page when using the Browser app:

1. Scroll to the area of the Web page containing the text you want to select.
2. Touch and hold the text you want to copy. Drag tabs to expand or reduce the range of the selected text. Any selected text will appear highlighted.

Tip: Touch **SELECT ALL** to select all the text on the Web page.

3. Touch  > **Copy**.
4. Open the application that you want to paste into.
5. Touch and hold the text box where you want to paste the text to, and touch **PASTE**.

To copy a URL:

1. To copy a URL, touch and hold the URL to display the options menu.
2. Touch **Copy link URL** or .
3. Open the application that you want to paste into.
4. Touch and hold the text box where you want to paste the URL to, and touch **PASTE**.

Phone Calls

With the Sprint National Network and your phone's calling features, you can enjoy clear phone calls across the country.





Note: The calling information in this section refers to traditional wireless phone calls. For information on making and answering Direct Connect calls, Group Connect calls, and TeamDC calls, see [Sprint Direct Connect](#).

Make Phone Calls

There are several convenient ways to place calls from your phone.

Call Using the Phone Dialpad

The most "traditional" way to place a call is by using the phone's dialpad.





1. Press **Home**  > . If the dialpad is not displayed, touch the Phone tab .
2. Touch the number keys on the dialpad to enter the phone number.
3. Touch the Talk key  to call the number.



4. To end the call, touch .





Call from Call Logs

The Call logs list lets you quickly place calls to recent incoming, outgoing, or missed numbers.

1. Press **Home**  >  to display the phone app.
2. Touch the Call log tab  to display the Call log list.
3. Touch the phone icon  next to the number or contact to place a call.
 - For additional options, touch the name or number.

Call from Contacts



You can place phone calls directly from entries in your Contacts list.

1. Press **Home**  >  to display the phone app.
2. Touch the People tab  to display the People list. Your frequent contacts are displayed at the top of the list.
 - Touch  to search your contact.
 - Press **Menu**  > **Contacts to display** to customize the display of contacts. See [Display Options](#).
3. Touch the contact you want to place a call.

For additional information on Contacts, see [People](#).

Call Using a Speed Dial Number

Speed dialing lets you contact friends and family easier. See [Set Up Speed Dialing](#) for information on assigning speed dial numbers.



1. Press **Home**  >  > .
2. For speed dial numbers 2-9, touch and hold the number on the dialpad.

– or –

For speed dial numbers 10-99, touch the first digit and then touch and hold the second digit on the dialpad.

Call a Number in a Text Message or Email Message







While viewing a text message or email message, you can place a call to a number that is in the body of the message.

1. Press **Home**  >  > **Messaging**. If necessary, select a messaging or email account.
2. Touch the message with the phone number.
3. The Phone screen then opens, with the phone number automatically filled in and ready to be dialed. To place the call, touch .

Call Emergency Numbers

You can place calls to 911 even if the phone's screen is locked or your account is restricted.

To call the 911 emergency number:

1. Flick  to unlock the screen, if the slide screen lock is on.
2. Touch  on the screen.
3. Touch    .

To call the 911 emergency number when the pattern screen lock, the facial screen lock, the PIN screen lock or the password screen lock is on:

1. Touch **Emergency call** on the screen.
2. Touch    .

Once an emergency call is placed, your phone will be in Emergency mode for the following five minutes after the call where non-emergency calls cannot be made.

To exit Emergency mode immediately:

- ▶ Press **Menu**  > **Exit Emergency mode** > **Yes**.

Enhanced 911 (E911) Information

This phone features an embedded Global Positioning System (GPS) chip necessary for utilizing E911 emergency location services where available.

When you place an emergency 911 call, the GPS feature of your phone seeks information to calculate your approximate location. Depending on several variables, including availability and access to satellite signals, it may take up to 30 seconds or more to determine and report your approximate location.





Important: Always report your location to the 911 operator when placing an emergency call. Some designated emergency call takers, known as Public Safety Answering Points (PSAPs), may not be equipped to receive GPS location information from your phone.

Call Numbers with Pauses

You can dial phone numbers with pauses for use with automated systems, such as voicemail or credit card billing numbers.





There are two types of pauses available on your phone:

- **Add 2-sec pause:** Automatically sends the next set of numbers after two seconds.
- **Add wait:** Sends the next set of numbers when you touch **Yes** in the pop-up window.

1. Press **Home**  >  > , and enter all or part of a number.
2. Press **Menu**  > **Add 2-sec pause** or **Add wait**.
3. Enter additional numbers.
4. Touch the Talk key  to dial the number.

Call Using the Plus (+) Code

When placing international calls, Plus Code Dialing automatically enters the international access code for your location (for example, 011 for international calls made from the U.S.).

1. Press **Home**  >  >  to display the phone screen.
2. Touch and hold  until you see a “+” on the display screen.
3. Enter the country code and phone number, and then touch . The phone automatically prepends the access code for international dialing, followed by the country code and phone number.

Call Using Internet Calling

When Wi-Fi network is available, you can make and receive calls through an Internet calling account.

Important: Calling a phone number using Internet calling may incur additional charges.

Add an Internet Calling Account

1. Press **Home**  >  to display the phone screen.



2. Press **Menu**  > **Settings** > **SIP Accounts** > **Add account**.
3. Enter your account details.
4. To set your phone to receive Internet calls on your added account, select the **Receive incoming calls** check box.

Note: This requires the phone to maintain a connection with a Wi-Fi data network, which reduces the life of your phone's battery.

Make an Internet Call

1. Press **Home**  >  > **People**.
2. Touch a contact and then touch **Internet call**.

Internet Calling Setting

1. Press **Home**  >  to display the phone screen.
2. Press **Menu**  > **Settings** > **Use Internet calling**.
3. Select an option:
 - **For all calls when data network is available** to use Internet calling for all calls when Wi-Fi network is available.
 - **Only for Internet calls** to use Internet calling only for calls to Internet calling addresses.
 - **Ask for each call** to ask each time you make a call.

Receive Phone Calls

The following information lets you know how to answer incoming calls, mute the ringer on incoming calls, reject incoming calls, and more.

When you receive a phone call from a contact, the Incoming call screen appears and displays the caller ID icon, name, and phone number of the calling party. When you receive a phone call from someone who is not stored in People, only the default caller ID icon and phone number appear on the Incoming call screen.

Note: If your phone is turned off, all calls automatically go to voicemail.

Answer an Incoming Call

- ▶ On the Incoming call screen, flick the Answer icon .

Mute the Ringing Sound

To mute the ringer without rejecting the call:



- ▶ Press the volume button up or down.

Send an Incoming Call to Voicemail

- ▶ Flick the Ignore icon  to send the call to your voicemail inbox.

Reject a Call and Send a Text Message

You can reject an incoming call and automatically send a text message to the caller.

- ▶ Flick the Ignore & Text icon  to ignore the call and send a message to the caller.
 - You can edit the text messages through the Call settings menu. From the phone app, press **Menu**  > **Settings** > **Quick responses** and touch a preset text message to edit it.



Visual Voicemail

Visual Voicemail gives you a quick and easy way to access your voicemail. Now you can find exactly the message you are looking for without having to listen to every voicemail message first. This new feature periodically goes out to your voicemail, and gathers the caller information from all of the current voicemails. It then populates a list with the caller name and number, along with the length of time and priority level of the voicemail message.

Set Up Visual Voicemail

Setting up Visual Voicemail follows many of the same procedures as setting up traditional Sprint voicemail. You should set up your Sprint voicemail and personal greeting as soon as your phone is activated. Your phone automatically transfers all unanswered calls to your voicemail, even if your phone is in use or turned off.

Note: To set up your traditional voicemail box, see [Set Up Voicemail](#).

1. Press **Home**  >  > **Voicemail**.
2. Touch **Personalize now** and follow the system prompts to:
 - Create a password (part of standard voicemail).
 - Record your name announcement.
 - Record your greeting.

3. When prompted to enter information, touch **Dialpad** to bring up the onscreen dialpad to enter your numeric responses.

Important: **Voicemail Password** – Sprint strongly recommends that you create a password when setting up your voicemail to protect against unauthorized access. Without a password, anyone who has access to your phone is able to access your voicemail messages.

4. Once you have completed the setup process, return to the voicemail page (see step 1).
5. Touch the **Welcome to Voicemail** message on the screen to play a brief explanation of the voicemail services.

Review Visual Voicemail

Visual Voicemail lets you easily access and select which messages you want to review.



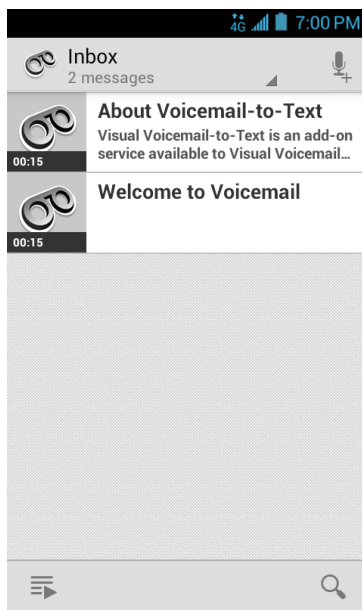





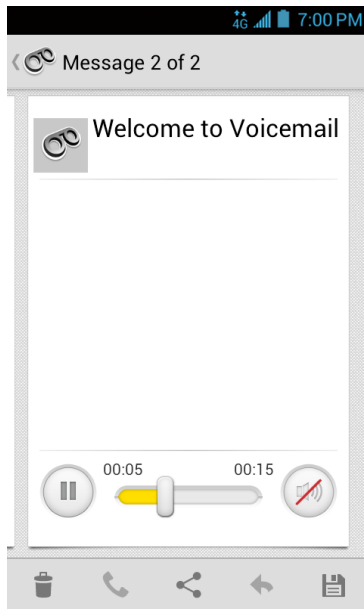

1. Press **Home**  >  > **Voicemail**. You will see the voicemail inbox.





Note: Touch **Inbox** at the top left on the screen to move to other folders, such as **Trash** or **Archive**.

2. Touch  to play all the new messages.
– or –
Touch a message to play it.
3. The following options may be available while reviewing a voicemail message:



- The bar  provides a visual timeline for the current message. Touch and drag this bar to scrub through the message to different points.
- Touch  to pause the playback. Touch  to resume.
- Touch  or  to turn the speakerphone on or off during playback.
- Touch  to delete the current voicemail message. The message will be moved to the trash folder.
- Touch  to call the number the message came from.
- Touch  to share the message. Select an available method and follow the onscreen instructions.
- Touch  to reply to the message via text or voice message.
- Touch  to archive the message. The message will be moved to the archive folder.
- Touch  to move the message to Inbox.

Tip: More options may be available by touching and holding a message, such as  or  to mark the message as read or unread, or  to empty the trash folder.

Listen to Multiple Voicemail Messages









When you are done listening to a voicemail message you can easily access other voicemail messages without returning to the main voicemail screen.

1. Listen to the current voicemail message.
2. Swipe your finger left or right to display the next or previous message. (It will begin playing automatically.)

You can navigate through voicemail messages as frequently as you'd like. You can even move to the next or previous message before you're finished listening to the current one.



Compose a Message

Record a voice message and share it.

1. Press **Home**  >  > **Voicemail** > .
2. Touch  to start recording.
3. Touch  to stop recording.
4. Touch  to review the recorded message.
 - Touch  > **Re-record** to discard the current message and start a new recording.
5. Touch  to select a method to share the recorded message and follow the onscreen instructions.
 - You will be asked to set a **Display name** if it is not set.



Configure Visual Voicemail Settings

The Visual Voicemail settings menu lets you access settings for notifications, pictures, greetings, and more.

1. Press **Home**  >  > **Voicemail**.
2. Press **Menu**  > **Settings**. Select an option to change its settings.
 - **Personalize voicemail** to change your voicemail greeting for incoming calls and update password. See [Change Your Main Greeting via the Voicemail Menu](#).
 - **Notifications** to determine how you are notified of new voicemails.
 - **Delete messages** to set the timing to permanently delete the messages in the trash folder.
 - **Display name** to enter a name that is attached to your outgoing voicemails as part of an identification string. See [Edit the Display Name via the Voicemail Menu](#).
 - **View quick tips tutorial** to display some quick tips for using visual voicemail.



- **Help** to go to the help page of Visual Voicemail.
- **Send feedback** to send your feedback on the visual voicemail.
- **Check for update** to search for an update to your Visual message software.
- **About Voicemail** to view build information about the current visual voicemail application.

Tip: You can restore messages you have sent to the trash folder. Touch **Inbox > Trash**, touch and hold the message you want to restore to the inbox, and then touch the restore icon .

Note: Voicemail settings can also be accessed by pressing **Home**  >  > **Menu**  > **Settings > Voicemail**.



Change Your Main Greeting via the Voicemail Menu

Your main greeting can be changed directly via the Visual Voicemail system. This direct access saves you from having to navigate within the voicemail menu.

1. Press **Home**  >  > **Voicemail**.
2. Press **Menu**  > **Settings > Personalize voicemail**.
3. Touch **OK** to connect to the Sprint voicemail system. Follow the prompts to change your current greeting.

Edit the Display Name via the Voicemail Menu

From your Visual Voicemail menu, you can quickly change the name or number attached to your voice messages.





1. Press **Home**  >  > **Voicemail**.
2. Press **Menu**  > **Settings > Display name**.
3. Touch the existing identification field and enter a new identifying name or number (used to identify you to recipients of your voice messages).
4. Touch **OK** to save your information.

Voicemail (Traditional)

In addition to [Visual Voicemail](#), your phone and Sprint service always offer traditional voicemail service accessed through the Phone application.

Set Up Voicemail

You should set up your Sprint Voicemail and personal greeting as soon as your phone is activated. Always use a password to protect against unauthorized access. Your phone automatically transfers all unanswered calls to your voicemail, even if your phone is in use or turned off.

1. Press **Home**  >  > .
2. Touch and hold  to dial your voicemail number.
3. Follow the system prompts to:
 - Create your password.
 - Record your name announcement.
 - Record your greeting.

Important: **Voicemail Password** – Sprint strongly recommends that you create a password when setting up your voicemail to protect against unauthorized access. Without a password, anyone who has access to your phone is able to access your voicemail messages.

Voicemail Notification

There are a couple of different ways your phone alerts you to a new voicemail message.

- By sounding the assigned notification sound.
- By vibrating the phone when the vibrate setting is on.
- By displaying  within the Notifications area of the Status bar when new unheard voicemail message(s) is received. The figure is the number of new messages. This icon means you have ten unheard new messages.





Note: When you are roaming off the Nationwide Sprint Network, you may not receive notification of new voicemail messages. Sprint recommends that you periodically check your voicemail by dialing 1 + area code + your wireless phone number. When your voicemail answers, touch  and enter your password. Roaming rates apply when you access voicemail while roaming off the Nationwide Sprint Network.

Note: Your phone accepts messages even when it is turned off. However, your phone notifies you of new messages only when it is turned on and you are in a Sprint service area.

Retrieve Your Voicemail Messages

You can review your messages directly from your wireless phone (using either traditional voicemail or Visual Voicemail) or from any other touch-tone phone.

Use Traditional Voicemail to Access Your Messages

1. Press **Home**  >  > .
2. Touch and hold . If prompted, enter your voicemail password.
3. Follow the voice prompts to listen to and manage your voicemail messages.

Use Visual Voicemail to Access Your Messages

1. Press **Home**  >  > **Voicemail**.
2. Touch an entry to listen to the message.

Note: Depending on your plan, you may be charged for airtime minutes when you are accessing your voicemail from your wireless phone.

Use Another Phone to Access Messages

1. Dial your wireless phone number.
2. When your voicemail answers, press the asterisk key on the phone (*).
3. Enter your password.

Phone Call Options

Your phone application provides many useful features and options to help you make the most of your calling experience.

In-call Options

While you're on a call, you will see a number of onscreen options. Touch an option to select it.

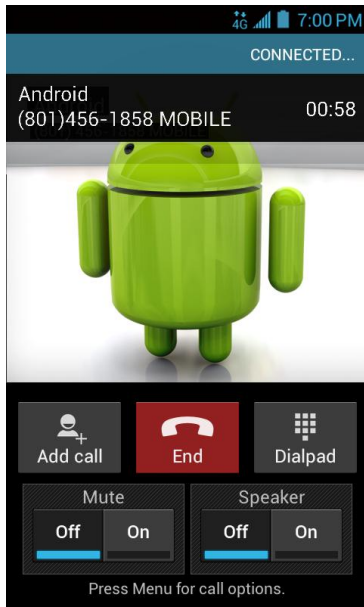

- **Add call:** Touch to initiate a 3-way call.
- **End:** End the current call.
- **Dialpad/Hide:** Toggle the appearance of the onscreen dialpad to enter additional numbers such as an extension or access code.
 - For example: When you call your bank's 800 number, use your dialpad to enter your account number and PIN.
- **Mute:** Mute the microphone (**On**) during an active call, or unmute the microphone (**Off**).

Note: If Mute is activated, the speaker mode is deactivated.

- **Speaker:** Route the phone's audio through the speaker (**On**) or through the earpiece (**Off**).







Warning: Because of higher volume levels, do not place the phone near your ear during speakerphone use.

Press **Menu**  during a call to display a list of additional in-call features. Touch an option to select it.

- **Contacts:** Display your contacts list.
- **Bluetooth:** Route the phone's audio through a connected Bluetooth headset (On) or through the speaker (Off).

Caller ID

Caller ID identifies a caller before you answer the phone by displaying the number of the incoming call. If you do not want your number displayed when you make a call, follow these steps.

1. Press **Home**  >  > .
2. Touch   .
3. Enter a phone number.
4. Touch .

To permanently block your number, call Sprint Customer Service.

Call Waiting



When you're on a call, Call Waiting alerts you to incoming calls by sounding two beeps. Your phone's screen informs you that another call is coming in and displays the caller's phone number (if available).

To respond to an incoming call while you're on a call:

- ▶ Flick . This puts the first caller on hold and answers the second call.

To switch back to the first caller:

- ▶ Touch **Switch calls**.

Note: For those calls where you don't want to be interrupted, you can temporarily disable Call Waiting by pressing    before placing your call. Call Waiting is automatically reactivated once you end the call.

3-Way Calling

With 3-way calling, you can talk to two people at the same time. When using this feature, the normal airtime rates will be charged for each of the two calls.

1. On the Phone screen, enter a number and touch  (or place a call from Log or Contacts).
2. Once you have established the connection, touch **Add call**, and dial the second number (or place the call from Logs or Contacts). This puts the first caller on hold and dials the second number.
3. When you're connected to the second party, touch **Merge calls**. Your conference call is now in session.

4. To end the 3-way call, touch .







Note: If one of the people you called hangs up during your call, you and the remaining caller stay connected. If you initiated the call and are the first to hang up, all callers are disconnected.

Call Forwarding









Call Forwarding lets you forward all your incoming calls to another phone number – even when your phone is turned off. You can continue to make calls from your phone when you have activated Call Forwarding.

Note: You are charged a higher rate for calls you have forwarded.

To activate Call Forwarding:

1. Press **Home**  >  > .
2. Touch   .
3. Enter the area code and phone number to which you want your calls forwarded.
4. Touch . You will hear a tone to confirm the activation of Call Forwarding.



To deactivate Call Forwarding:

1. Press **Home**  >  > .
2. Touch    .
3. Touch . You will see a message and hear a tone to confirm the deactivation.



Set Up Speed Dialing

You can store up to 98 numbers in your phone's speed dial memory.



To assign a speed dial number to a contact:

1. Press **Home**  > .
2. Press **Menu**  > **Speed dial setup**.
3. Touch **Add speed dial** next to the location number you want to assign a number to.
4. Select a contact and, if the contact has more than one number, select a number.

To remove a number from a speed dial location:

1. Press **Home**  > .
2. Press **Menu**  > **Speed dial setup**.
3. Touch the assigned contact you want to remove and touch **Remove** > **OK**.







To replace a number in a speed dial location:

1. Press **Home**  > .
2. Press **Menu**  > **Speed dial setup**.
3. Touch the assigned contact you want to replace and touch **Replace**.
4. Select a contact and, if the contact has more than one number, select a number.

Call Logs

The Call log tab of the Phone application lists max. 500 recent incoming, outgoing, and missed calls.



View Call Logs





1. Press **Home**  > .
2. Touch the Call log tab  to display the Call log list.
 - You can determine if an entry was an incoming, outgoing, or a missed call from the icons shown below.
 -  = Incoming Call
 -  = Outgoing Call
 -  = Missed Call

Call Log Options

- ▶ To make a call from the Call logs, see [Call from Call Logs](#).





For additional options:

1. Press **Home**  > .
2. Touch the Call log tab  to display the Call log list.

3. Touch a listing to display the options:
 - Touch  to send a text message.
 - Touch  to view the contact.
 - Touch  to add the number to People.
 - Press **Menu**  > **Remove from call log** to remove the log.
 - Press **Menu**  > **Edit number before call** to edit the number before calling.

Clear Call Logs



Use the menu option to clear your Call logs.

1. Press **Home**  > .
2. Touch the Call log tab  to display the Call log list.
3. Press **Menu**  > **Clear call log** > **OK**.



Call Settings

Your phone's Call Settings menu lets you configure your voicemail options and a number of other settings for the phone application.

North American Dialing

1. Press **Home**  > .
2. Press **Menu**  > **Settings**.
3. Select the **North American dialing** check box when placing international calls while in the United States or Canada. See [Call Using the Plus \(+\) Code](#).





International Dialing

1. Press **Home**  > .
2. Press **Menu**  > **Settings**.
3. Clear the **North American dialing** check box and touch **International dialing** to set the international dialing code when placing international calls from outside the United States or Canada. See [Make and Receive Worldwide Calls](#).



TTY Mode

A TTY (teletypewriter, also known as a TDD or Text Telephone) is a telecommunications device that allows people who are deaf, hard of hearing, or who have speech or language disabilities, to communicate by telephone.

Your phone is compatible with select TTY devices. Please check with the manufacturer of your TTY device to ensure that it supports digital wireless transmission. Your phone and TTY device will connect using a special cable that plugs into your phone's headset jack. If this cable was not provided with your TTY device, contact your TTY device manufacturer to purchase the connector cable.

When establishing your Sprint service, please call Sprint Customer Service using the state Telecommunications Relay Service (TRS) by first dialing    . Then provide the state TRS with this number: **866-727-4889**.

To turn TTY Mode on or off:

1. Press **Home**  > .
2. Press **Menu**  > **Settings** > **TTY mode**.
3. Touch **TTY Full**, **TTY HCO**, or **TTY VCO** to turn TTY mode on.

– or –

Touch **TTY Off** to turn TTY mode off.

Note: When enabled, TTY mode may impair the audio quality of non-TTY devices connected to the headset jack.

Warning: **911 Emergency Calling**

Sprint recommends that TTY users make emergency calls by other means, including Telecommunications Relay Services (TRS), analog cellular, and landline communications. Wireless TTY calls to 911 may be corrupted when received by public safety answering points (PSAPs), rendering some communications unintelligible. The problem encountered appears related to TTY equipment or software used by PSAPs. This matter has been brought to the attention of the FCC, and the wireless industry and the PSAP community are currently working to resolve this.

Sprint Direct Connect

Sprint® Direct Connect® on your Sprint phone offers instant, two-way “walkie-talkie-style” communication between you and your family, friends, and co-workers, all at the click of a button. Perfect for get-in get-out conversations such as checking status, getting information, getting directions, or coordinating with others—fast. Call Alert sends an alert to other Direct Connect users to let them know you want to reach them.

Important: Currently, Sprint Direct Connect is not available on the **LTE** network. To use Sprint Direct Connect, select the **CDMA only** mode in the **Network mode** setting. See [When You Subscribe to Sprint Direct Connect Services](#).

About Sprint Direct Connect

Learn the services available with Sprint Direct Connect.

The following Sprint Direct Connect services are available:

- **Direct Connect®** - Allows two-way radio communication with other Direct Connect users.
- **Group Connect®** - Creates and manages groups in Contacts, “on the fly,” or online to connect instantly with up to 20 other Direct Connect users at the same time. (Currently Sprint phones do not support Group Connect calls with Nextel or PowerSource phones.)
- **TeamDCSM** and **Opt-In TeamDC** - Create a group online that allows nationwide group calling with up to 200 other Direct Connect users (with Sprint phones only). With TeamDC and Opt-In TeamDC, all members can access the most up-to-date group list on their phones.

Before Making Your First Direct Connect Call

To enable Direct Connect on your phone, a Sprint Customer Service representative must add Direct Connect services to your account. Please call Sprint Customer Service at **1-888-211-4727** for more information.

Important: When the Direct Connect feature is active, your phone’s data services are enabled.

Your Direct Connect Number

Your Sprint phone allows you two different options for your Direct Connect number.

Your Direct Connect number will be one of the following:

- Separate number (**DC ONLY**) - Your Direct Connect number is a unique number (not your wireless number). It is made up of three sets of digits separated by asterisks (for example, 444*5555*111).
- A single number - Your Direct Connect number is the same as your wireless number (for example, 555-555-1234).

Dial Direct Connect Numbers

Understand the types of Direct Connect numbers for making Direct Connect calls.

- If the person you are calling has a separate number for Direct Connect, make sure you dial any asterisks (*) in the number. If you are saving the number in your Contacts, choose **DC ONLY** for the phone type.
- If the person you are calling has a single number for both voice calls and for Direct Connect, use that ten-digit phone number to make Direct Connect calls. You do not need to add any asterisks (*) to the number. If you are saving this number in your Contacts, choose other than **DC ONLY** for the phone type.

Tip: Users with a Nextel phone must always add asterisks (*) between sets of numbers to dial Direct Connect numbers. If you use a single number, make sure to tell your contacts with Nextel phones to dial the number using asterisks (*) in place of hyphens (for example, 555*555*1234).

Tip: One way to easily ensure that your contacts have your correct number is to call them so that they can save your number from their Call logs. Ask them for their contact information. Remember you will need all digits of the number to make a successful call. Also, if they have a Nextel phone or a separate number for Direct Connect, you will need to enter asterisks (*) between sets of numbers.

Save a Direct Connect Number

You can store Direct Connect numbers in your Contacts just like traditional phone numbers.

1. Use your dialpad to enter a Direct Connect number.
 - The Direct Connect number may be the ten-digit wireless phone number of the contact.
 - or –
 - The Direct Connect number may be a unique number made up of three sets of digits separated by asterisks (for example, 444*5555*111). When saving this type of number, always include the asterisks (*).
2. Press **Menu**  > **Add to contacts**.

3. To add the number to an existing contact, touch the contact, select a number type for the new number, and then touch **OK**.

– or –

To add the number as a new contact, touch **CREATE NEW CONTACT**, enter the name and any additional information, and then touch **DONE**. See [Add a Contact](#).

- When selecting a number type for the entry:
 - Select **DC ONLY** if the Direct Connect number is different from the wireless phone number. Make sure to include the asterisks (*) between the sections of a DC ONLY number.
 - Select other than **DC ONLY** if the wireless phone number and the Direct Connect number are the same.

Note: All Direct Connect users with Nextel or PowerSource phones must ALWAYS use an asterisk (*) between sets of digits, even if they are calling another user whose Direct Connect number is the same as their wireless phone number. Make sure to include the asterisks when giving your number to a Nextel or PowerSource user (for example, if your number is 555-555-1234, when giving it to a Nextel or PowerSource user, it should be 555*555*1234).

Display Your Direct Connect Number

Your Direct Connect number and other information about your phone and account will be displayed.

▶ Press **Home**  > **Menu**  > **System settings** > **About phone** > **Status**.

Make and Answer Direct Connect Calls

You can make a Direct Connect call by entering a Direct Connect number manually or by selecting an entry containing a Direct Connect number in your Contacts or History. For information on saving Direct Connect numbers to Contacts, see [Save a Direct Connect Number](#).

Make a Direct Connect Call by Entering a Number





Place a Direct Connect call by entering a Direct Connect number with your keypad.

Recent DC's Tab
Touch to display the Direct Connect call history.

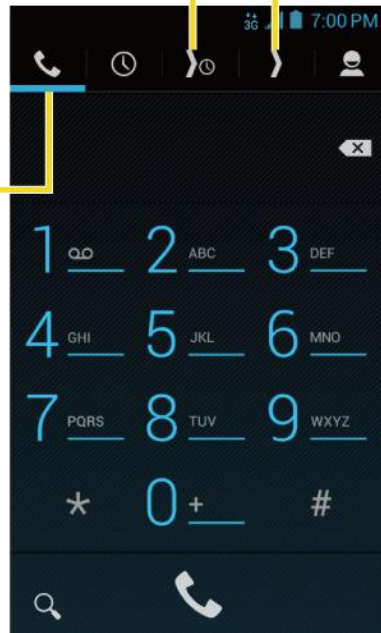
DC Call List Tab
Touch to display the Direct Connect call Contacts.

Tab Indicator
Indicates which tab is displayed.





1. Press **Home**  >  > .
2. Enter a Direct Connect number.
 - The Direct Connect number may be the ten-digit wireless phone number of the person you are calling.
 - or –
 - If calling a Nextel customer, the Direct Connect number may have three parts with an asterisk between each part (for example: 444*5555*111). When dialing or saving this type of number, always include the asterisks ().
3. Press and release the Direct Connect button (DC button) on the side of your phone.
 - Pressing and releasing the DC button “pings” the recipient. The recipient’s phone emits an incoming tone and displays your name or number. If available, he or she can choose to respond and begin the conversation.
 - Alternatively, you can hold the button and speak after you first press and hear the tone. In this case, your voice will broadcast instantly over the recipient’s speaker. Pinging the recipient’s phone by pressing and releasing may avoid unintentional interruptions.
4. After the recipient accepts your call:
 - Wait for **“Push to Talk”** to appear onscreen.

- Press and hold the DC button.
 - Wait for a tone to sound and “Me” to appear onscreen before you begin talking.
5. Release the DC button to listen.
 6. Touch  to end the call.

Note: All Direct Connect calls end automatically if there is no activity on the call for several seconds.

Make a Direct Connect Call from Contacts

Place a Direct Connect call to the Direct Connect numbers stored in your Contacts.

1. Press **Home**  >  > **People** > .
2. Touch an entry you want to place a Direct Connect call.
3. Touch the number with “**DC ONLY**” or “**Direct Connect XXX**” under it.



– or –

Touch **Direct Connect** or press the DC button, and select a number.

- Select the **Remember this choice** check box first if you want to select the number as default for a Direct Connect call to the contact.
4. Press and release the DC button.
 5. Continue the Direct Connect call as described previously.

Make a Direct Connect Call Using a Speed Dial Number

Place a Direct Connect call to assigned speed dial numbers. See [Set Up Speed Dialing](#) for information on assigning speed dial numbers.

1. Press **Home**  >  > .
2. Enter a speed dial number and press and release the DC button.
3. Press and release the DC button.
4. Continue the Direct Connect call as described previously.

Make a Direct Connect Call from Recent DC's

Place a Direct Connect call from your Direct Connect Call logs.

1. Press **Home**  >  > .

– or –



Press the DC button to display your Direct Connect (including Call Alert and Invite) Call logs. See [One Touch DC](#).

2. Touch  next to the entry you want to place a Direct Connect call.
3. Continue the Direct Connect call as described previously.

Tip: To redial your most recent Direct Connect call, press the DC button on the recent DC's screen.

Make a Direct Connect Call from the DC Call List

The DC Call list contains the number and group you can place a Direct Connect call to.

1. Press **Home**  >  > .
2. Touch an entry to place a Direct Connect call.
3. Continue the Direct Connect call as described previously.

Availability Notifications

You will receive a message when you place a Direct Connect call to a contact and that contact is on another call. You can press the DC button to try again, or you may be able to send a request to be notified when the contact becomes available.

To send a request:

- ▶ Touch **Notify when available**.

When you receive a requested notification, you can respond in various ways. If you receive a notification while in a DC call, touch **Call back** to finish the current call and respond to the notification.

To return the call:

1. With the notification displayed, press and hold the DC button.
2. Continue with the Direct Connect call as previously detailed.

To place a voice call:



- ▶ Press the speaker button.

To dismiss a notification:

- ▶ Touch **Ignore**.

Answer Direct Connect Calls

When you receive a Direct Connect call, you hear an incoming tone or the phone vibrates, depending on your settings. You will see the Direct Connect number and the caller's name (if available) on your screen. You may also hear the caller's voice through the speakerphone. Default for Direct Connect calls is speakerphone on. You can turn the speakerphone off and listen to Direct Connect calls through the earpiece as you would a regular call, or you can listen through a headset.

1. Press the speaker button to either enable or disable the Direct Connect speakerphone feature.
 - If you enable the Direct Connect speakerphone (), you will hear the caller's voice through the speakerphone on the front of the phone.
 - If you disable the Direct Connect speakerphone (), you will only hear the caller's voice through the earpiece.
2. Accept the incoming call. If available, the caller's name and Direct Connect number also appear on the display.
3. When the caller has finished speaking, you will hear a tone and see **"Push to Talk"** on the display.
4. Press and hold the DC button and wait for a tone to sound and a message ("**Me**") to appear onscreen. Continue the Direct Connect call as described previously.

Tip: Touch  to dismiss an incoming Direct Connect call.

Tip: Press **Menu**  > **Bluetooth** to route the audio through a paired Bluetooth device.

Convert a Direct Connect Call to a Phone Call

1. While on a Direct Connect call, touch **Convert call**.
2. Read the message, and then select a number (if more than two numbers are available) or touch **Convert call**. Your phone ends the Direct Connect call and dials the selected number.

Tip: **Quieting incoming calls and increasing your privacy.** When you are in an area where incoming Direct Connect calls may disturb others, or if you wish to increase the privacy of your calls, please set your speakerphone to "off" and your ringer to "vibrate." When the speakerphone is off, Direct Connect calls use the phone's earpiece and microphone, while still utilizing the DC button. You may also use an earbud or other hands-free device for increased convenience.

End a Direct Connect Call

There are two ways to disconnect a Direct Connect call.

- ▶ Do nothing; the call will automatically end after several seconds if neither party presses the DC button.

– or –





Touch .

Call Alerts

Call Alerts let you notify others that you want to communicate with them using Direct Connect. When a user receives a Call Alert, the phone sounds a tone and displays your name or Direct Connect number.

Send a Call Alert

Send a notification to start a Direct Connect call.

1. Press **Home**  >  > . Enter a Direct Connect number and press **Menu**  > **Send Call alert**.

– or –

Touch  on the Contacts details screen, the Recent DC's details screen, the DC Call list screen, or the Quick contact screen.

Note: When sending a Call Alert, make sure you select the Direct Connect number for the person you are trying to reach.

2. Touch **Add text** and select a text, if you want to attach a preset text to the alert.

Important: Preset text messages with Call Alerts can only be sent to and from Direct Connect users with Sprint phones. If you send a Call Alert with text to another Direct Connect subscriber without this capability (such as a Nextel user), the user will receive the Call Alert but will not receive the text message.

Note: There is no additional charge to send preset text messages with Call Alerts.

3. Press and release the DC button. (The receiving phone emits an incoming tone and displays an alert.)

Tip: If you get an error message saying that your contact “is not reachable via Direct Connect” or “this number is not DC capable,” please check to see that you have entered or highlighted a valid Direct Connect number.

Reply to a Call Alert

Call Alerts continue to repeat for a set amount of time or until you return the call or dismiss the alert. See [Call Alerts](#) to adjust the settings. If you receive a Call Alert while in a DC call, touch **Call back** to finish the current call and respond to the Call Alert.

To reply to a Call Alert:

1. With the Call Alert displayed, press and hold the DC button to return the call.
2. Continue with the Direct Connect call as previously detailed.

To place a voice call:

- ▶ Press the speaker button.

To dismiss a Call Alert:

- ▶ Touch **Dismiss**.

Group Connect

A Group Connect call is a Direct Connect call made to up to 20 Direct Connect users with Sprint phones nationwide at one time.

You can make a Group Connect call in several different ways:

- By setting up a group entry in Contact on your phone.
- By using the Sprint Mobile Sync tool at sprint.com. See [Sprint Mobile Sync](#).
- By selecting or entering multiple numbers for a one-time call.

For information on creating groups and storing them in Contacts, see [Add a Group Connect Contact](#).

Important: When making a Group Connect call or creating a group list for Group Connect calls in Contacts, you must select an entry's Direct Connect–capable number. If you select a number that is not Direct Connect–capable, the name will be added to the list, but Group Connect calls will not go through to that group member.

Make Group Connect Calls

You can make Group Connect calls by selecting saved groups from your Contacts, selecting from group calls saved in Call log, or by creating groups for one-time use.

Make a Group Connect Call from Contacts

1. Press **Home**  >  > **People** > .

2. Touch  next to the group entry you want to place a Group Connect call.
3. Continue the Group Connect call in the same manner as a one-to-one Direct Connect call.





Note: Only one person at a time may speak on a Group Connect Call.

4. When you are finished, touch  to end the call. (By default, when you end a Group Connect call that you initiated, all other participants are dropped from the call. To change this option, see [Group Call Options](#).)



Note: If you get an error message saying that your contact “is not reachable via Direct Connect” or “this number is not DC capable,” please check to see that you have entered or highlighted a valid Direct Connect number.

Note: Currently Sprint phones do not support Group Connect calls with Nextel and PowerSource phones. This enhancement is planned for future implementation. If your calls are not going through, please check to see whether your contact is using a Sprint phone.





Make a Group Connect Call from Recent DC's

1. Press **Home**  >  > .
2. Touch  next to the group entry you want to place a Group Connect call to.
3. Continue the Group Connect call as described previously.

Make a Group Connect Call from the DC Call List





1. Press **Home**  >  > .
2. Touch a group entry to place a Group Connect call.
3. Continue the Group Connect call as described previously.

Make a Group Connect Call without Saving the Group

1. Press **Home**  >  > **People** > .
2. Press **Menu**  > **DC Multiple**.
3. Select entries from the People list.
4. When you have finished selecting entries, press the DC button.
5. Continue the Group Connect call as described previously.

Join or Rejoin a Group Connect Call

If you are not available at the beginning of a Group Connect call, or if you drop off the call temporarily, you can rejoin the in-progress Group Connect call.

1. Press **Home**  >  > .
2. Touch  next to the group entry you want to join or rejoin.
3. Continue the Group Connect call as described previously.

Tip: You may also join or rejoin a Group Connect call from your Contacts. Touch  next to the group entry.

Note: If the Group Connect call has already ended, pressing the DC button initiates a new Group Connect call.

Note: If you do not want to participate in a Group Connect call, touch .

Group Connect Call Information

Your phone's display may show some useful information during a Group Connect call.

During a Group Connect call, the following information may appear on your screen:

- The name of the group.
- The name or Direct Connect number of the person speaking.
- The number of group members who are connected to the call out of the number invited (for example, 4 out of 6).

TeamDC

TeamDC lets Direct Connect users make group calls to up to 200 other users nationwide. With TeamDC, any Direct Connect or Sprint user can create a TeamDC group online, which the system then automatically pushes to all the group members' phones. Once a user creates and distributes a TeamDC group, any member of the group can make a TeamDC call to the entire group. If the user who created the group makes any changes to the group, the system automatically sends updates to the members' phones.

Note: The TeamDC feature supports group calls only with Direct Connect users with Sprint phones. You cannot include users with Nextel phones in TeamDC groups.

Set Up a TeamDC Group

Any Direct Connect subscriber on a Sprint phone can create TeamDC groups online. Only the TeamDC group creator or an account administrator may modify a group member list once he or she has created it.

1. Sign on to your account at sprint.com.
2. From your account summary page, click **My device & media > Contacts > Launch Mobile Sync > My Contacts > Add group > TeamDC**.
3. Add TeamDC members directly (using Direct Connect numbers) or select individual members or groups from your Contacts list.
4. **(Optional)** Click **Set Talker Priority** to select a Talker Priority for each group member (default is **Medium**).
 - You can assign a priority of **Low**, **Medium**, or **High** to each member.
 - During a TeamDC call, members with a higher Talker Priority can “break in” when members with a lower priority are speaking.

Note: Talker Priority: The optional TeamDC “Talker Priority” feature lets you define a priority level (Low, Medium, or High) for each member of a TeamDC group. When a TeamDC call is active, members with a higher priority may interrupt a member with a lower priority while that member is speaking. By default, the system sets all members of a TeamDC group to a “Medium” priority level.

5. Click **Save** to save the TeamDC group and distribute it to the other group members.

Update TeamDC Groups

Connect to the network to keep your TeamDC groups’ list up-to-date.

1. Press **Home**  >  > **People** > .

– or –

Press **Home**  >  > .

2. Select a TeamDC entry and touch  on the bottom of the screen.
 - Your phone will connect to the network and retrieve a current list of TeamDC groups for your account.

Make a TeamDC Call

Place a call to the members in a TeamDC group.

1. Press **Home**  >  > **People** > .

– or –

Press **Home**  >  > .





2. Touch  next to the TeamDC group you want to make a TeamDC call.

Tip: You can touch an entry from **Home**  >  > .

3. Continue the TeamDC call as any other Direct Connect or Group Connect call.
4. When you are finished, press  to end the call. (By default, when you end a TeamDC call that you initiated, all other participants are dropped from the call. To change this option, see [Group Call Options](#).)

Join or Rejoin a TeamDC Call

If you are not available at the beginning of a call, or if you drop off the call temporarily, you can rejoin the in-progress TeamDC call.





1. Press **Home**  >  >  .
2. Touch  next to the TeamDC group you want to make a TeamDC call.
3. Continue the TeamDC call as described previously.

Tip: You may also join or rejoin a TeamDC call from your **Contacts**. Touch  next to the TeamDC group.

Note: If the TeamDC call has already ended, pressing the DC button initiates a new TeamDC call.

Remove Yourself from a TeamDC Group

You may have the option to remove yourself from a TeamDC group.

1. Press **Home**  >  > **People** > .
2. Touch an entry to display the TeamDC group details screen.
3. Press **Menu**  > **Remove Me**.
4. Touch **Remove**.

Note: This action also deletes the TeamDC group you belonged to from your **Contacts**.

Note: TeamDC group membership can either be forced or non-forced. With a forced TeamDC group, an end user on the same account cannot be removed from the group, whereas a user not on the same account can.

TeamDC Call Information

Your phone's display may show some useful information during a TeamDC call.

During a TeamDC call, the following information may appear on your screen:





- The name of the group.
- The name or Direct Connect number of the person speaking.
- The number of TeamDC members who are connected to the call out of the number invited (for example, 4 out of 6).

Opt-In TeamDC

Opt-In TeamDC works like a chatroom. You can make and manage Opt-In TeamDC groups in the same way as you would for TeamDC groups on the Web. You can also send an Invite during an Opt-In TeamDC call to the group members who have not yet joined the call. (See [Send an Invite during a call.](#))

Scan Lock

At any given time, you can specify which TeamDC and Opt-in Team DC groups you wish to be active on your phone. You can either participate in all TeamDC and Opt-in TeamDC calls for which you are a member, or select specific groups to be active.

1. Press **Home**  >  > **People** > .
2. Press **Menu**  > **List TeamDC Group** > **Menu**  > **Scan lock**.
3. Select an option:
 - **Receive all TeamDC calls** to allow TeamDC calls, Opt-In TeamDC calls, and Invites for all groups.
 - **Select which TeamDC calls to receive** to allow TeamDC calls, Opt-In TeamDC calls and Invites for certain groups only. Select the groups and touch **OK**.

Invites

You can send an Invite to initiate a Group Connect call. When the group members receive an Invite, their phones sound a tone and display your name (if it is in Contacts).

While on a call, you may also send an invitation message to a specific Contacts entry, or to the group members who have not joined the call yet.

Send an Invite

You can send an Invite to initiate a call. You can also send an Invite during a call to those who have not joined the call yet.

Send an Invite to start a call

To send an Invite to start an Opt-In TeamDC call:

1. Select a group from Recent DC's or Contacts and touch  next to the Opt-In TeamDC entry.
2. When the group is not active, a message appears. Read the message and touch **Invite**.

Send an Invite during a call

To send an Invite during an Opt-In TeamDC call to the group members who have not joined the call yet:

- ▶ While on an Opt-In TeamDC call, touch **Send invites**.

To send an Invite during a Direct Connect or Group Connect call to a personal or group Contacts entry:

1. While on a Direct Connect or Group Connect call, touch **Add to call**.
2. Select an entry from the displayed list.
3. Touch **Invite**.

Reply to an Invite

Respond to an Invite to return the call, place a voice call, or dismiss it. If you receive an Invite while in a DC call, touch **Call back** to finish the current call and respond to the Invite.

To reply to an Invite:

1. With the DC Invite displayed, press and hold the DC button to return the call.
2. Continue with the Direct Connect call as previously detailed.

To place a voice call:

- ▶ Press the speaker button.

To dismiss an Invite:

- ▶ Touch **Ignore**.

Direct Connect Settings

Some Direct Connect settings menus are available when you subscribe to Sprint Direct Connect services.

Turn Direct Connect On and Off

By default, your phone's Direct Connect feature is turned on.

1. Press **Home**  > **Menu**  > **System settings** > **Direct Connect settings** > **Direct Connect**.

2. Touch **On** or **Off**.

Your phone displays the DC Off icon () on the status bar when Direct Connect is turned off.



Note: Sprint Direct Connect is not available in LTE/CDMA mode. See [When You Subscribe to Sprint Direct Connect Services](#).

Note: Disabling Direct Connect from your phone's settings menu does not affect your subscription status to Sprint Direct Connect services.

Direct Connect Permissions



You can control which numbers can reach your phone using Direct Connect.

Set Permissions Approach



1. Press **Home**  > **Menu**  > **System settings** > **Direct Connect settings** > **Permissions** > **Choose approach**.
2. Touch **Accept all DC calls, except those from numbers I block.** or **Reject all DC calls, except those from numbers I allow..**
3. Touch **OK**.

Edit Permissions List

To add an entry to the list:

1. Press **Home**  > **Menu**  > **System settings** > **Direct Connect settings** > **Permissions**.
2. Touch **Edit block contacts list** or **Edit allow contacts list**.
3. Touch **Add new** and select an option:
 - **New number:** Enter a number and name and touch.
 - **From contacts:** Select entries from the People list.
 - **From recent DC's:** Select entries from the recent DC's list.
4. Touch **Add** or **OK**.



To remove an entry from the list:

1. Press **Home**  > **Menu**  > **System settings** > **Direct Connect settings** > **Permissions**.
2. Touch **Edit block contacts list** or **Edit allow contacts list**.

3. Touch the delete icon next to the listing you want to remove.



Group Call Options

Set the way to end a group call you initiated.

1. Press **Home**  > **Menu**  > **System settings** > **Direct Connect settings** > **Group call options**.
2. Select an option:
 - **Allow the call to continue.:** Keeps the call active even after you hang up. The call will remain active until the last member disconnects.
 - **End the call for everyone.:** Terminates the call session for all connected members when you hang up.

DC Headset Mode



You can use the headset button as the DC button.

1. Press **Home**  > **Menu**  > **System settings** > **Direct Connect settings**.
2. Select the **DC headset mode** check box to enable the function.

One Touch DC

You can select the function of the DC button when you press it in standby mode. By default, it displays your Direct Connect (including Call Alert and Invite) Call logs. You can also select to enable or disable the assigned function of the DC button when the phone's display is off in idle state.



To assign a function to the DC button:

1. Press **Home**  > **Menu**  > **System settings** > **Direct Connect settings** > **One touch DC**.
2. Touch **Action** and select an option.
 - **Launch DC call log list** to display your Direct Connect Call logs.
 - **Launch contacts list** to display your Contacts list.
 - **DC selected contact** to place a Direct Connect call to a selected number. Select **Contacts**, **Recent DC's**, or **New number** and enter or select the number to specify.
 - **DC most recent number** to place a Direct Connect call to the latest number listed in your Direct Connect Call logs.
 - **Off** to disable one touch DC.

3. Touch **Action when screen off** and select an option.
 - **Enable** to enable the one touch DC function even when the screen is off.
 - **Disable** to disable the one touch DC function when the screen is off.

Beep During a DC Call

While on a DC call, you can control the beep sound for missed DC calls, Invites, Call Alerts and Availability Notifications.

1. Press **Home**  > **Menu**  > **System settings** > **Direct Connect settings**.
2. Select the **Beep during DC call** check box to hear the sound during DC calls, or clear the check box to mute it.

People

The People application lets you store and manage contacts from a variety of sources, including contacts you enter and save directly in your phone as well as contacts synchronized with your Google Account, your PC, compatible email programs.

Get Started with People

Before using People, it's best to learn a few basics.

Contacts List



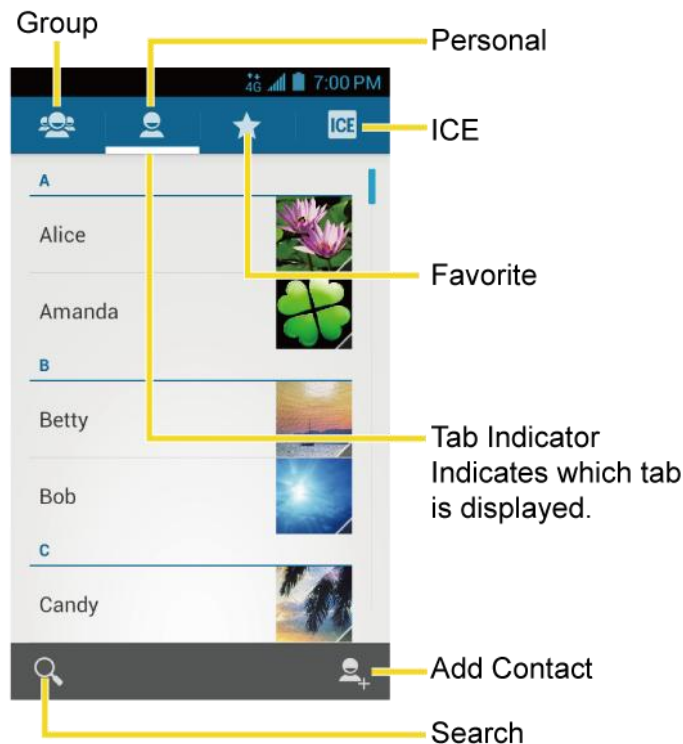

- ▶ Press **Home**  >  > **People**. You will see the Contacts list.



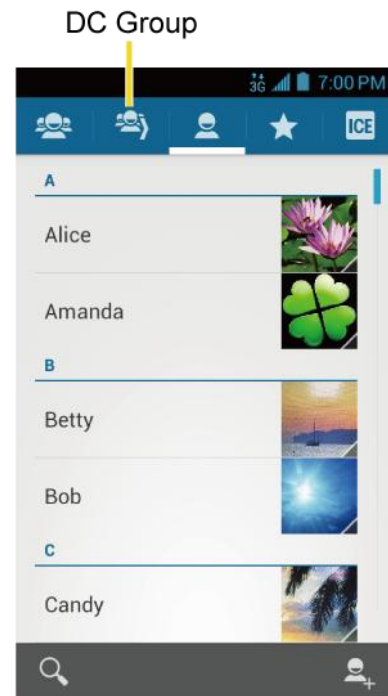

< Contacts List without Direct Connect >



< Contacts List with Direct Connect >





-  **Group**: Touch to display the Group of contacts.
-  **DC Group**: Touch to display the DC Group of contacts.
-  **Personal Contact**: Touch to display the individual contacts.
-  **Favorite**: Touch to display your favorite contacts.

-  **ICE:** Touch to display your ICE (in case of emergency) contacts and your information.
-  **Add contact:** Touch to add a contact. See [Add a Contact](#).
-  **Add group:** Touch to add a group contact. See [Add a Group Contact](#).
-  **Add Group Connect contact:** Touch to add a Group Connect contact for Direct Connect calls. See [Add a Group Connect Contact](#).
-  **Search:** Touch to search a contact.

Scroll through the list to view all your contacts. To see a specific entry, scroll to it and touch it.

Tip: If you have a lot of contacts stored, you'll see a slider on the right when you're flicking up or down the list. To go directly to a letter, touch and hold the slider and drag it to a letter.

Contacts List Options

1. Press **Home**  >  > **People**.
2. Press **Menu**  to display the contacts list options:
 - **List TeamDC Group:** Displays a list of TeamDC groups. You can select a group to be active on your phone. See [Scan Lock](#).
 - **DC Multiple:** Selects contacts and place a DC call. See [Make a Group Connect Call without Saving the Group](#).
 - **Contacts to display:** Selects contacts to be displayed on People. See [Display Options](#).
 - **Import/export:** Imports/exports contacts from/to the microSD card or shares your visible contacts.
 - **Accounts:** Opens the Accounts & sync settings screen. See [Accounts & Sync Settings](#).
 - **Settings:** Opens the Display options page. You can select how your contacts are displayed. See [Display Options](#).



Display Options

Select which contacts to be displayed on People.

1. Press **Home**  >  > **People** > .





2. Press **Menu**  > **Contacts to display**.
3. Select an option:
 - **All contacts:** Displays all the contacts you save.
 - **Customize:** Selects the contacts to display. Touch an account and select the types of contacts to be displayed by checking them, or uncheck those types you don't wish to display. Touch **OK**.

You can also select how your contacts to be displayed.

1. Press **Home**  >  > **People**.
2. Press **Menu**  > **Settings**.
3. Set the following options:
 - **Sort list by** to choose how your contacts are sorted.
 - **View contact names as** to choose how your contacts name is displayed.

Add a Contact

Enter details such as name, phone numbers, email addresses, mailing addresses, and more.

1. Press **Home**  >  > **People** > .
2. Touch  to add a contact.
 - You may be prompted to select a type of the contact:
 - Select an account to save contacts to from the displayed list.
 - Touch **Add new account** to save contacts to a new account. Select **Google** or **Corporate**.
 - They will be synced automatically with your Google Account online.
3. Use the keyboard to enter as much information as you want.

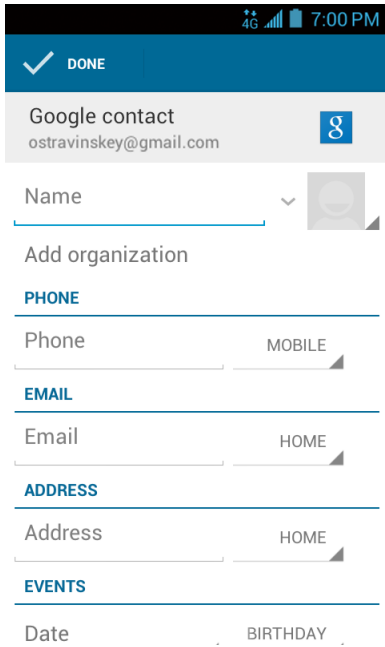

-  : Touch the picture icon to assign a picture to the contact. See [Assign a Stored Picture to a Contact](#) or [Assign a New Picture to a Contact](#).
- **Name**
- **Add organization**
- **PHONE**
- **EMAIL**
- **ADDRESS**
- **EVENTS**
- **GROUPS**
- **Add another field:** Touch to include additional information such as **IM**, **Notes**, **Nickname**, **Website**, etc.





Note: To select a type (label) for a phone number, email address, or postal address (such as **MOBILE**, **HOME**, **WORK**, etc.), touch the type to the right of the field and select the appropriate type.

Note: To add more phone numbers, email addresses, etc., touch **Add new** under the current numbers or addresses.

4. When you have finished adding information, touch **DONE**.

Save a Phone Number

You can save a phone number to People directly from the phone dialpad.

1. Press **Home**  >  > .
2. Enter a phone number and press **Menu**  > **Add to contacts**.
3. To add the number to an existing contact, touch the contact, select a number type for the new number, and then touch **OK**.

– or –





To add the number as a new contact, touch **CREATE NEW CONTACT**, enter the name and any additional information, and then touch **DONE**. See [Add a Contact](#).

Edit a Contact

Once you've added a contact, you can add or edit any of the information in the entry, assign a caller ID picture, customize with a unique ringtone, and more.

Add or Edit Information for a Contact

Use the Edit contact menu to add or edit information for an existing contact.





1. Press **Home**  >  > **People** > .
2. Touch a contact to display it, and then press **Menu**  > **Edit**.
3. Touch any field you want to change or add. See [Add a Contact](#).
4. Add or edit the information, and then touch **DONE**.

Note: To select a type (label) for a phone number, email address, or postal address (such as **MOBILE**, **HOME**, **WORK**, etc.), touch the type to the right of the field and select the appropriate type.

Note: To add more phone numbers, email addresses, etc., touch **Add new** under the current numbers or addresses.

Assign a Stored Picture to a Contact





The Edit contact menu lets you assign a picture stored in your phone's memory or SD card to a contact.

1. Press **Home**  >  > **People** > .
2. Touch a contact to display it, and then press **Menu**  > **Edit**.

3. Touch the contact icon to the right of the name.
4. Touch **Choose photo from Gallery** and select a location.
5. Touch a picture to select it.
 - You may be prompted to size the picture for use with contacts. Touch and drag the square to frame the portion of the picture to use. Touch and drag the side of the square to resize the square and touch **CROP**.
6. Touch **DONE** to save the contact.





Assign a New Picture to a Contact

Follow the instructions to take a new picture and assign it directly to an existing contact.

1. Press **Home**  >  > **People** > .
2. Touch a contact to display it, and then press **Menu**  > **Edit**.
3. Touch the contact icon to the right of the name.
4. Touch **Take photo**.
5. Touch  to take a picture. If you're satisfied with the picture, touch **OK** to continue.
 - You may be prompted to size the picture for use with contacts. Touch and drag the square to frame the portion of the picture to use. Touch and drag the side of the square to resize the square and touch **CROP**.
6. Touch **DONE** to save the contact.





Assign a Ringtone to a Contact

Know who's calling without looking at your phone by assigning a specific ringer to a contact.

1. Press **Home**  >  > **People** > .
2. Touch a contact to display it, and then press **Menu**  > **Set ringtone**.
3. Touch an available ringtone.
 - When you touch a ringtone, you will hear a sample.
4. Touch **OK** to assign the ringtone.



Assign a Vibration to a Contact

You can assign a specific vibration pattern to a contact.

1. Press **Home**  >  > **People** > .
2. Touch a contact to display it, and press **Menu**  > **Set vibrate**.
3. Touch an available vibration.
 - When you touch a vibration, you will feel a vibration.
4. Touch **OK** to assign the vibration.





Add a Contact to Favorites

The Favorites tab of the Phone menu is a listing that can help you quickly access your most used or preferred contacts entries.

1. Press **Home**  >  > **People** > .
2. Touch a contact.
3. Touch the star at the upper right corner. The star turns to white.





Send a Contact's Call to Voicemail

You can transfer your contact's voice call to voicemail anytime you receive it.

1. Press **Home**  >  > **People** > .
2. Touch a contact to display it and press **Menu** .
3. Check **All calls to voicemail**.

Delete a Contact





You can delete a contact from the contacts details page.

1. Press **Home**  >  > **People** > .
2. Touch a contact to display it, and press **Menu**  > **Delete**.
3. Touch **OK**.

Add a Group Contact

Create a group contact with your personal contact entries in People.





Note: In order to create a group contact, you may first sync your phone with a Google or Corporate account. See [Synchronize Contacts](#) for instructions on how to sync your phone to an account.

1. Press **Home**  >  > **People** > .
2. Touch  to add a group contact.
3. Enter the group's name.
4. Type the person's name. As you type, matching entries in your People will come up. Touch an entry to select it.
5. Repeat step 4 to select all the members in the group.
6. Touch **DONE**.





Edit a Group Contact

Manage the group contacts you create.

Add or Remove the Group Contact, or Rename the Group

1. Press **Home**  >  > **People** > .
2. Touch an entry and press **Menu**  > **Edit**.
3. The following options are available:
 - Touch the group's name to rename it.
 - Touch **Type person's name** to add an entry to the group.
 - Touch  next to the entry you want to remove from the group.
4. Touch **DONE**.

Delete a Group Contact





1. Press **Home**  >  > **People** > .
2. Touch an entry and press **Menu**  > **Delete** > **OK**.

DC Group Contact

Your phone stores Group Connect entries, TeamDC entries, and Opt-In TeamDC entries in DC group contact. You can store up to 25 Group Connect entries. Each Group Connect entry can contain up to 20 members for making Direct Connect group calls. Currently, Sprint phones do not support Group Connect calls with Nextel or PowerSource phones. When creating a group entry, please make sure to include only users with Sprint phones. The TeamDC and Opt-In TeamDC entries are created and managed online. See [TeamDC](#).

Add a Group Connect Contact





Create a Group Connect contact with your personal contact entries in People.

1. Press **Home**  >  > **People** > .
2. Touch  to add a DC group contact.
3. Touch **Add new** and select the entries from the available list and touch **OK**.
4. Touch **OK** and enter the group's name.
5. Touch **DONE**.





Edit a Group Connect Contact

Manage the Group Connect contacts you create.

Add or Remove the Group Connect Contact, or Rename the Group

1. Press **Home**  >  > **People** > .
2. Touch an entry and press **Menu**  > **Edit**.
3. The following options are available:
 - Touch the group's name to rename it.
 - Touch **Add new** to add an entry to the group.
 - Touch  next to the entry you want to remove from the group.
4. Touch **DONE**.

Delete a Group Connect Contact

1. Press **Home**  >  > **People** > .
2. Touch an entry and press **Menu**  > **Delete** > **OK**.

ICE (In Case of Emergency)

Registering ICE information might help rescue workers, such as paramedics and police officers, as well as hospital personnel identify your primary contact or special medical need you might have in case of emergency.

To register an ICE contact:

1. Press **Home**  >  > **People** > .

2. Touch **ICE contacts** > **Menu** .
3. Touch **Add ICE Call** or **Add ICE Text**. You can register one Call contact and up to four Text contacts.
4. Touch the entry to register.



To change or remove an ICE contact:

1. Press **Home**  >  > **People** > **ICE** > **ICE contacts**.
2. Touch the contact to replace and touch **Change** to select another contact. Select a new contact from the displayed list.



– or –

Touch the contact to remove and touch **Remove** > **OK**.

To enter or edit the emergency message:

1. Press **Home**  >  > **People** > **ICE**.
2. Touch **Emergency message** > **Menu**  > **Edit**.
3. Enter or edit the message and touch **DONE**.

To enter or edit your own information:

1. Press **Home**  >  > **People** > **ICE**.
2. Touch **My information** > **Menu**  > **Edit**.
3. Enter or edit the necessary information and touch **DONE**.

To access the ICE information:

1. Touch **ICE** if it appears on the locked screen.

– or –

Flick  if the slide screen lock is on, and press **Home**  >  > **People** > **ICE**.

2. The following options are available:
 - Touch **My information** to display the registered information.
 - Touch  > **OK** to place a call to the ICE contact.



- Touch  > **OK** to send a text message to the ICE contact. The GPS information will be attached to the message.

Synchronize Contacts

Syncing data from your managed accounts lets you add and manage new or existing contacts from your online or remote accounts to your phone. Prior to syncing, you must have an active Google or corporate account with associated contacts, and be signed into your account with the phone.

With syncing, any contacts (with phone numbers, email addresses, pictures, etc.) are updated and synced with your phone.

For more information about syncing existing managed accounts, see [Accounts & Sync Settings](#).

1. Press **Home**  > **Menu**  > **System settings** > **Accounts & sync**.
2. Touch the account you want to sync your contacts with.
3. Touch **Sync Contacts**.





Note: The process of updating your contacts tab can take several minutes. If after 10-20 minutes, your list has not been updated, repeat steps 2 and 3.

Your People then reflects any updated contact information.

- This update process works both ways. For example, any changes on the phone are updated to your Gmail contacts list after sync.

Share a Contact

You can quickly share contacts using Bluetooth, email, Gmail, or text messaging.

1. Press **Home**  >  > **People** > .
2. Touch a contact to display it, and press **Menu**  > **Share**.
3. In the **Share contact via** menu, select a method:
 - **Bluetooth** to send the information via Bluetooth. See [Bluetooth](#) for information on pairing and sending via Bluetooth.
 - **Email** to send the information as an email attachment. If prompted, select an email account. Address the message, add a subject and a message, and then touch **Send**. See [Compose and Send Email](#) for details on sending email.
 - **Gmail** to send the information as a Gmail attachment. Address the message, add a subject and a message, and then touch **Send**. See [Send a Gmail Message](#) for details.

- **Messaging** to send the information in a text message. Select a contact or enter a wireless phone number or email address, enter any additional information, and then touch **Send**. For more information on text messaging, see [Text Messaging and MMS](#).

Sprint Mobile Sync

You can add and edit all your contacts and groups, including TeamDC and Opt-In TeamDC groups, online using the Sprint Mobile Sync service.

With Sprint Mobile Sync you can:

- **Add and edit contacts and groups.** Use your computer to easily add, edit, and manage contacts and groups, and set up and manage TeamDC and Opt-In TeamDC groups.
- **Synchronize and back up your contacts.** Save all the contacts information from your phone in a secure location, and automatically synchronize new information from the computer to the phone and from the phone to the computer.
- **Transfer contacts to a new phone.** When you activate a new phone, Sprint Mobile Sync sends your existing contact information to the phone upon activation.
- **Erase contact information from a lost phone.** If your phone is lost or stolen, Sprint Mobile Sync can remotely remove all the contact information. You can then send the information to your replacement phone.
- **Import and export contacts with online address books.** Import or export contact information from or to Outlook, or other compatible databases.

Access Sprint Mobile Sync Online

1. Sign on to your **My Sprint** page at sprint.com.
2. Click **My device & media > Contacts > Launch Mobile Sync**.

Follow the onscreen instructions to add, edit, and manage all your contact information.

Accounts and Messaging

With Sprint service and your phone's messaging capabilities, you have the opportunity to share information through many different channels and accounts, including Gmail (Google), personal and corporate email, text and multimedia messaging, social networking accounts, and Google Talk.

Gmail / Google

You will need a Google Account to access several phone features such as Gmail, Google Maps, Google Talk, and the Google Play Store applications. Before you are able to access Google applications, you must enter your account information. These applications sync between your phone and your online Google Account.

Create a Google Account



If you do not already have a Google Account, you can create one online or using your phone.

Note: Although you need a Gmail account to use certain features of your phone, such as Google Play Store, you do not need to use Gmail as the default account for your phone.

Create a Google Account Online

1. From a computer, launch a Web browser and navigate to google.com.
2. On the main page, click **Sign in > Create an account for free**.
3. Follow the onscreen prompts to create your free account.

Create a Google Account Using Your Phone

1. Press **Home**  > **Menu**  > **System settings > Accounts & sync**.
2. Touch **ADD ACCOUNT > Google > New**.
3. Enter your First name and Last name, and then touch **Next**.
4. Enter a desired Username, and then touch **Next**.
5. When prompted, enter and reenter a Password and touch **Next**.
6. Create a security question and answer, enter a secondary email address to help you recover your password if you ever lose it, and then touch **Next**.



Note: When setting up a new Google Account, either on your phone or online, you will be prompted to add a secondary email address. Enter a second Gmail address or any other email address from which you currently send and receive email. This address is used to

authenticate your account should you ever encounter problems or forget your password. It is strongly encouraged for Android users so you can regain access to Google Mobile™ services and purchases on your phone.

7. Select if you join Google+ now.
8. Read and accept the Google Terms of Service, and then touch **I accept**.
9. Enter the letters from the Authenticating screen and then touch **Next**.
10. Select if you save your credit card information now to enable purchases at the Google Play Store.
11. Select the items you would like to sync with your phone and touch **Next**. Your account is displayed on the list.



Sign In to Your Google Account

If you have a Google Account but have not yet signed in with your phone, follow these instructions to sign in to your Google Account.

1. Press **Home**  > **Menu**  > **System settings** > **Accounts & sync**.
2. Touch **ADD ACCOUNT** > **Google** > **Existing**.
3. Enter your Gmail username and password, and then touch **Sign in**.
4. Select if you join Google+ now.
5. Select if you save your credit card information now to enable purchases at the Google Play Store.
6. Select the items you would like to sync with your phone and touch **Next**. Your account is displayed on the list.

Access Gmail



Access your personal Gmail account directly on your phone.

1. Press **Home**  >  > **Gmail**.
2. Do any of the following:
 - View more email messages: If the inbox is full, swipe your finger up the screen to view more messages and conversations.
 - Read a new email message: Touch the unread message or the conversation with an unread message (just-arrived items display in bold).

- Select messages and conversations: Touch the box before the email or conversation.
- View the inbox of your other Gmail account:
 - Touch the account name at the top of the inbox, and then touch the account you want to view.
- Refresh the inbox: Touch the sync icon .

Send a Gmail Message

Use your phone to send Gmail messages.

1. Press **Home**  >  > **Gmail**.
2. In the inbox, touch .
3. Enter the message recipient's email address in the **To** field. If you are sending the email message to several recipients, separate the email addresses with a comma. As you enter email addresses, any matching addresses from your contacts list are displayed. Touch a match to enter that address directly.

Tip: You can enter a name saved in People to call up the email address. Touch a match from an available list.

4. If you want to send a carbon copy (Cc) or a blind carbon copy (Bcc) of the email to other recipients, press **Menu**  > **Add Cc/Bcc**.
5. Enter the subject, and then compose your email.

Note: If you want to attach a picture, press **Menu**  > **Attach file**. Locate and then touch the picture you want to attach.



6. After composing your message, touch .

Note: While composing the message, press **Menu**  > **Save draft** to save it as a draft. To view your draft messages, in the inbox, touch **Inbox** (top of the Gmail screen), and then touch **Drafts**.





Note: To view your sent messages, in the inbox, touch **Inbox** and then touch **Sent**.

Read and Reply to Gmail Messages

Your phone allows you to access, read, and reply to all your Gmail messages.

1. Press **Home**  >  > **Gmail**.
2. Touch a message to display it.

Tip: You can also access new messages through the Notifications bar. When a new Gmail message arrives, you'll see the  icon in the status bar. Slide the bar down to display notifications. Touch a message to display it.



3. To reply to or forward a message:
 - Touch  to reply to the message.
 - Touch  > **Reply all** to reply to all recipients.
 - Touch  > **Forward** to forward the message.
4. After composing your message, touch .

Email



Use the Mail application to send and receive email from your webmail or other accounts, using POP3 or IMAP, or access your Exchange ActiveSync account for your corporate email needs.

Add an Email Account

You can add several types of personal email accounts, such as POP3 and IMAP accounts, on your phone.

1. Press **Home**  > **Menu**  > **System settings** > **Accounts & sync** > **ADD ACCOUNT** > **Email**.



– or –

Press **Home**  >  > **Email**.
2. Enter the **Email address** and **Password** for the email account and then touch **Next**.
 - Touching **Next** prompts your device to attempt a "regular" email setup and test the incoming and outgoing servers.
 - If you have custom settings you need to configure, touch **Manual setup** and enter your settings. These may include mail type, user name, password, server, security type, etc.
3. Touch the type of account, if prompted.
4. Confirm the Account settings and touch **Next**.
5. Enter the name to be displayed on your outgoing messages and touch **Next**. The inbox of the account is displayed.

Important: If the account type you want to set up is not in the phone database, you will be asked to enter more details. You should get all pertinent information for the email account, such as incoming and outgoing server settings, before you proceed.

Add a Corporate Account

If you synchronize your phone with your corporate account, you can read, manage, and send email in the same easy way as with a POP3/IMAP account. However, you can also access some powerful Exchange features.

1. Press **Home**  > **Menu**  > **System settings** > **Accounts & sync**.
2. Touch **ADD ACCOUNT** > **Corporate**.
3. Enter the **Email address** and **Password** information and then touch **Next**. Consult your network administrator for further details:
 - **Email address:** your corporate email address.
 - **Password:** typically your network access password (case-sensitive).
4. Enter the **Username**, **Password**, **Server**, and **Domain** information:
 - **Username:** enter your network login username.
 - **Password:** typically your network access password (case-sensitive).
 - **Server:** your exchange server remote email address. Typically it is in the form mail.XXX.com. Obtain this information from your company's network administrator.
 - **Domain:** enter your network domain.
5. If your network requires SSL encryption, select the **Use secure connection (SSL)** check box and activate this additional level of security. If your exchange server requires this feature, leaving this field unchecked can prevent connection.
6. Touch **Next**.
7. If the onscreen activation disclaimer is displayed, touch **Next**.
8. Configure your **Inbox checking frequency**, **Days to sync** (days to synchronize between your phone and server), and activate any other email settings, then touch **Next**.

Note: Signal interruptions or incorrect user name or password information can cause completion issues.



9. Identify your new account with a unique name and touch **Next**.

Note: You can have multiple corporate email (Microsoft® Exchange ActiveSync®) accounts active on your device.

Note: Your corporate Exchange Server must support auto-detect for the phone to automatically set up the Exchange ActiveSync account. If your corporate Exchange Server does not support auto-detect, you will need to enter your Exchange Server settings after you touch **Next**. Ask your Exchange Server administrator for details.

Compose and Send Email

Compose and send email using any account you have set up on your phone. Increase your productivity by attaching files such as pictures, videos, or documents to your email messages.



1. Press **Home**  >  > **Email**.
2. On the email account inbox, touch .

Tip: Touch the account name at the top of the screen to switch to a different email account.

3. Enter email addresses directly in the **To** field. If you're sending the email to several recipients, separate the email addresses with a comma. As you enter email addresses, any matching addresses from your contacts list are displayed. Touch a match to enter the address directly.

Tip: You can enter a name saved in People to call up the email address. Touch a match from an available list.

Tip: If you want to send a CC or a BCC of the email to other recipients, press **Menu**  > **Add Cc/Bcc**.

4. Enter the subject, and then compose your message.
5. To add an attachment, press **Menu**  > **Attach file**, and choose from the following options:
 - **Pictures:** Select photos from Gallery.
 - **Videos:** Select videos from Gallery.
 - **Audio:** Select sound files.
6. Touch  to send the message immediately, or press **Menu**  > **Save draft** to save it as a draft.

Note: To open a draft email, in the email account inbox, touch **Inbox** (top of the Email screen) and then touch **Drafts**.

View and Reply to Email

Reading and replying to email on your phone is as simple as on your computer.

1. Press **Home**  >  > **Email**.

2. On the email account inbox, touch the message you want to view.



Tip: Touch the account name at the top of the screen to switch to a different email account.

3. Touch , or touch  > **Reply all**, to reply to the message.

Manage Your Email Inbox

Your email inbox provides management options for viewing, sorting, and deleting your email messages.

View Your Email Inbox

1. Press **Home**  >  > **Email**.
2. Touch the email account at the top of the screen to select a different inbox.

Refresh an Email Account

Whatever your automatic synchronization settings are, you can also synchronize your sent and received email messages manually at any time.

- ▶ While viewing the account you want to synchronize, touch .

Delete an Email Message



1. On the email account Inbox, select the check box next to the message you want to delete.
2. Touch .

Delete Multiple Email Messages

1. On the email account inbox, select the check box next to the messages you want to delete.
2. Touch .

General Email Settings



You can edit the general settings of your email.

1. Press **Home**  >  > **Email**.
2. Press **Menu**  > **Settings** > **General**:
 - **Auto-advance:** Choose which screen to show after you delete a message.
 - **Message text size:** Select the message text size.

- **Reply all:** Check if you want to display “**Reply all**” option as default.
- **Ask to show pictures:** Touch if you want to be asked before pictures in messages to be displayed.

Email Account Settings



You can edit settings for your individual email accounts, such as email address and password, name display and signature, frequency of retrieval, and more.

1. Press **Home**  >  > **Email**.
2. Press **Menu**  > **Settings**.
3. Select the email account you want to edit.
4. Set the following options. Some options are available to corporate account only:
 - **Account name:** Edit your account name.
 - **Your name:** Edit your name displayed on your emails.
 - **Signature:** Create an email signature for your outgoing emails.
 - **Quick responses:** Edit the text you frequently insert when composing emails.
 - **Inbox view:** Select how the inbox is displayed from **Normal View** and **Conversation View**.
 - **Default account:** Check to assign this account as the default email used for outgoing messages.
 - **Inbox check frequency:** Select the time interval used by your phone to check your new emails from **Automatic (Push)**, **Never**, **Every 5 minutes**, **Every 10 minutes**, **Every 15 minutes**, **Every 30 minutes**, and **Every hour**.
 - **Enable Peak-Time:** Set the two sets of time intervals to check your new emails – one for peak time and the other for off peak-time.
 - **Frequency during Peak-Time:** Select the time interval used by your phone to check your new emails during peak time.
 - **Frequency during Off Peak-Time:** Select the time interval used by your phone to check your new emails during off peak time.
 - **Peak-Time schedule:** Set a period of time to be the peak time according to the days of the week.
 - **Days to sync:** Set a period of time to synchronize your account.

- **Sync email:** Check to synchronize your email.
- **Sync contacts:** Check to synchronize your contacts.
- **Sync calendar:** Check to synchronize your calendar.
- **Download attachments:** Check if you want to automatically download attachments via Wi-Fi.
- **Email notifications:** Check to display the email notification icon on the status bar when a new mail is received.
 - **Choose ringtone:** Select a ringtone for new email messages.
 - **Vibrate:** Select a vibration pattern for new email messages.
- **Incoming settings:** Adjust the incoming email parameters, such as username, password, and other incoming connection parameters (ex: IMAP server).
- **Out of office settings:** Set your current status and your message to reply automatically while you are out of the office.
- **Remove account:** Touch to remove the account.

Delete an Email Account

If you no longer want an email account on your phone, you can delete it through the mail settings menu.

1. Press **Home**  >  > **Email**.
2. Press **Menu**  > **Settings**.
3. Select the account you want to delete.
4. Touch **Remove account** > **OK**.

Text Messaging and MMS



With Text Messaging (SMS), you can send and receive instant text messages between your wireless phone and another messaging-ready phone.

Multimedia messages, or MMS, can contain text and pictures, recorded voice, audio or video files, picture slideshows.

See your service plan for applicable charges for messaging.

Compose Text Messages

Quickly compose and send text messages on your phone.

1. Press **Home**  >  > **Messaging**.
2. On the Messaging screen, touch . The Compose screen opens.
3. Fill in one or more recipients. You can:
 - Enter phone numbers or email addresses in the **To** field. If you're sending the message to several recipients, separate the phone numbers or email addresses with a comma. As you enter information, any matching phone numbers or addresses from your contacts list are displayed. Touch a match to enter that number or address.

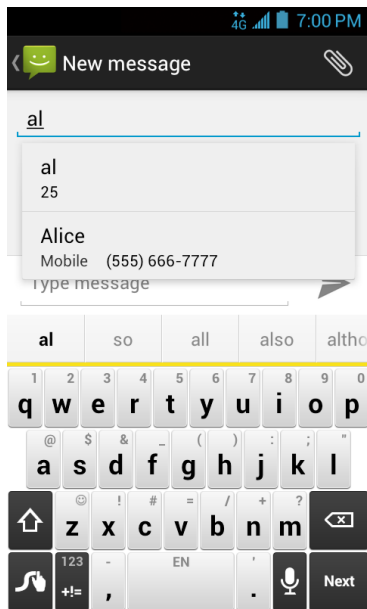



Note: You can add a subject line by touching **Menu**  > **Add subject**.

4. Touch **Type message** and then start composing your message.
5. When done, touch  to send the text message.



Send a Multimedia Message (MMS)

When you need to add a little more to a text message, you can send a multimedia message (MMS) with pictures, recorded voices, audio or video files, or slideshows.

1. Press **Home**  >  > **Messaging**.
2. On the Messaging screen, touch . The Compose screen opens.
3. Fill in one or more recipients. You can:
 - Enter phone numbers or email addresses in the **To** field. If you're sending the message to several recipients, separate the phone numbers or email addresses with



a comma. As you enter information, any matching phone numbers or addresses from your contacts list are displayed. Touch a match to enter that number or address.

Note: You can add a subject line by pressing **Menu**  > **Add subject**.

4. Touch **Type message** and then start composing your message.
5. Touch  and select from the following file attachments:
 - **Pictures:** Open **Gallery** to attach a photo from your storage card.
 - **Capture picture:** Open the camera application to take a photo and attach it.
 - **Videos:** Open **Gallery** to attach a video from your storage card.
 - **Capture video:** Open the video camera application to record a video and attach it.
 - **Audio:** Select a ringtone and attach it.
 - **Record audio:** Open the sound recorder application to create a recording and attach it.
 - **Slideshow:** See [Create a Slideshow](#) for details.
6. To make changes to your attachment, touch **Replace** or **Remove**.
7. Touch  to send the MMS message.

Create a Slideshow

In a multimedia message, you can add slides, each containing a picture, video, or audio.

1. In the multimedia message you're composing, touch  > **Slideshow**.
2. To compose your slideshow, do any of the following:
 - Touch **Add slide** to create a new slide. (This is a placeholder for new images to be added, similar to a playlist.)
 - Touch the created slide (example, Slide 1), touch **Add picture**, and then select the picture you want to add to the slide.
 - Touch the text field below the image to enter a caption for the picture.
 - Touch **Preview** (to preview the slide), **Replace picture** (to delete the currently selected picture), **Remove slide**, or press **Menu**  > **Add music**, **Add slide**, **Duration**, or **Layout**.





- When finished, touch **Done** to attach the slideshow to your message.

3. When you have finished composing the multimedia message, touch  or **Send**.

Save and Resume a Draft Message



While composing a text or multimedia message, press **Back**  > **Yes** to save your message as a draft.

To resume composing the message:

1. Press **Home**  >  > **Messaging**.
2. On the Messaging screen, touch the message to resume editing. “Draft” in red appears at the right of the message in the list.
3. When you finish editing the message, touch  or  .

New Messages Notification

Depending on your notification settings, the phone will play a ringtone, vibrate, or display the message briefly in the status bar when you receive a new text or multimedia message. To change the notification for new text and multimedia messages, see [Text and MMS Options](#) for details.

A new message icon  or  also appears in the notifications area of the status bar to notify you of a new text or multimedia message.

To open the message, slide the status bar down to open the Notifications panel. Touch the new message to open and read it. For information on reading and replying to messages see “Managing Message Conversations” in this chapter.

Managing Message Conversations

Text and multimedia messages that are sent to and received from a contact (or a number) are grouped into conversations or message threads in the Messaging screen. Threaded text or multimedia messages let you see exchanged messages (similar to a chat program) with a contact on the screen.

Read a Text Message

- ▶ Do one of the following:
 - On the Messaging screen, touch the text message or message thread to open and read it.
 - If you have a new message notification, slide the status bar down to open the Notifications panel. Touch the new message to open and read it.



To return to the Messaging screen from a text message thread, press **Back** .

Note: To view the details of a particular message, in the message thread, touch the message to open the options menu, and then touch **View details**.

Note: If a message contains a link to a Web page, touch the message and then touch the link to open it in the Web browser.

Note: If a message contains a phone number, touch the message and then touch the phone number to dial the number or add it to your contacts.





View a Multimedia Message (MMS)

1. Press **Home**  >  > **Messaging**.
2. On the Messaging screen, touch a multimedia message or message thread to open it.
3. Touch the attachment to open it.
4. To save the attachment to the storage card, touch and hold the message, and then touch **Save attachment** on the options menu.

Note: When **Auto-retrieve** in MMS settings is disabled, only the message header is downloaded. To download the entire message, touch the **Download** button at the right side of the message. For details, see [Text and MMS Options](#).

Note: If you are concerned about the size of your data downloads, check the multimedia message size before you download it.

Reply to a Message

1. Press **Home**  >  > **Messaging**.
2. On the Messaging screen, touch a text or multimedia message thread to open it.
3. Touch the text box at the bottom of the screen, enter your reply message, and then touch  or  .

Note: To reply to a text message with a multimedia message, open the text message and touch  . The text message is automatically converted into a multimedia message.

Delete a Message Thread

1. Press **Home**  >  > **Messaging**.

2. On the Messaging screen, touch and hold the message thread that you want to delete. The thread is highlighted and the number of the selected thread appears next to **Choose conversations**.

Tip: Repeat step 2 to select multiple threads.

3. Touch .
4. When prompted to confirm, touch **Delete**.

Delete a Single Message

1. While viewing a message thread, touch and hold the message that you want to delete.
2. From the options menu, touch **Delete**.
3. When prompted to confirm, touch **Delete**.

View Contact Information from a Message

When you have received a message from someone in your stored contacts, you can touch the contact's picture or icon in the message thread to open a menu of options. Depending on the stored contact information, you can view the contact details, phone or send an email message to the contact, and more.

Text and MMS Options

The messages settings menu lets you control options for your text and MMS messages including message limits, size settings, and notifications.

1. Press **Home**  >  > **Messaging**.
2. On the Messaging screen, press **Menu**  > **Settings**. You can set the following:

Storage Settings

- **Delete old messages:** Automatically delete older messages when the set limits are reached.
- **Text message limit:** Choose the maximum number of text messages to store in each conversation thread.
- **Multimedia message limit:** Choose the maximum number of MMS messages to store in each conversation thread.

Text (SMS) Messages Settings

- **Emergency Alerts:** Sets the federally supervised cell phone alert services to send out broadcast SMS messages for public warning:

- **Presidential:** Receives an emergency presidential alert. (Presidential is always grayed out [not selectable] and cannot be excluded.)
- **Imminent Threat - Extreme:** Select this option if you want to receive emergency alerts in an extreme emergency situation (an extraordinary threat to life or property).
- **Imminent Threat - Severe:** Select this option if you want to receive emergency alerts in a severe emergency situation (a significant threat to life or property).
- **Amber:** Select this option if you want to receive alerts related to missing or endangered children.
- **Emergency Alerts Test:** Select this option if you want to receive a test message to make sure that the alert messages can be successfully received.
- **Help:** Displays the help information for Emergency Alerts.

Multimedia (MMS) Messages Settings

- **Auto-retrieve:** Select this option to automatically retrieve all your multimedia messages completely. When selected, the multimedia message header plus the message body and attachments will automatically download to your phone. If you clear this check box, only the multimedia message header will be retrieved and shown in your Messaging screen.
 - **Roaming auto-retrieve:** Automatically retrieve all your messages completely when roaming. This may incur significant phone charges.

Notifications Settings

- **Notifications:** Select this option if you want to receive a notification in the status bar when a new text or multimedia message arrives.
 - **Choose ringtone:** Select a ringtone that is specific to new text and multimedia messages. Note that the ringtone briefly plays when selected.
 - **Vibrate:** Select this option if you want the phone to vibrate when a new text or multimedia message arrives.

Social Networking Accounts

Stay in touch on the go with all your social networking accounts.

YouTube

YouTube™ is a video sharing website on which users can upload and share videos. The site is used to display a wide variety of user-generated video content, including movie clips, TV clips, and music videos, as well as video content such as video blogging, informational shorts and other original videos.

Open YouTube



▶ Press **Home**  >  > **YouTube**.

Note: **Terms of Service** may appear. Touch **Accept**, if you agree to the **Terms of Service**.

Watch YouTube Videos

1. On the YouTube screen, touch a video.
2. Touch the screen to show the progress bar at the bottom. Touch the screen while the bar is displayed to pause/play the video. Move the slider on the bar to the left or right to rewind or fast-forward the video.

Search for Videos

1. On the YouTube screen, touch  at the upper right of the screen to open the search box.
2. Enter the keyword to search. Search results appear below the status bar.
3. Touch one of the results, or touch  or .
4. Scroll through the results and touch a video to watch it.

Google Talk

Google Talk is the instant messaging program provided by Google. Google Talk lets you chat with other people that also have a Google Account. Your Google Talk account is based on the Google Account set on your phone.

Sign In and Chat

You need to sign in the Google Talk before starting chatting.

▶ Press **Home**  >  > **Talk** to open Google Talk.

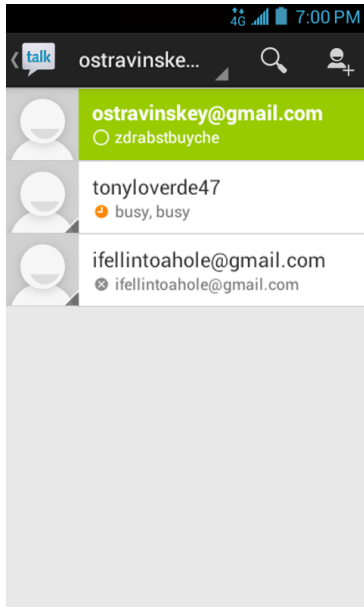

Add New Friends

You can add only people who have a Google Account.

1. On the friends list screen, touch .
2. Enter the Google Talk ID or the Gmail address of the person you want to add.
3. Touch **DONE**.

View Your Invitations

On the friends list screen, the friends you invited appear offline until they accept your invitation.

Accept or Cancel Invitations

On the friends list screen, touch **Chat invitation**. When an invitation pop-up window appears, touch **Accept** or **Cancel**.

Change Your Online Status Message

1. On the friends list screen, touch your email address at the top of the list.
2. Touch the status and select the status you want from the menu.
3. Touch the text box below the online status, and then type your status message.
4. Press **Back** .

Start a Chat

1. Touch a friend on the friends list.
2. Touch the text box, and then type your message.
3. Touch .

Switch Between Active Chats

You can conduct multiple chats at the same time and switch between active chats.

- ▶ On the friends list screen, touch the friend you want to chat with.

Close a Chat

- ▶ On a chat screen, press **Menu**  > **End chat**.

– or –

On the friends list screen, press **Menu**  > **End all chats**. All the chats will be closed.

Manage Your Friends

Friends on the friends list screen are sorted according to their online status and are listed alphabetically.

View the Friends List

You can sort your friends as you like.

- ▶ On the friends list screen, press **Menu**  > **Display options**.
 - **Availability** to show the friends that you frequently chat with first and now available first.
 - **Name** to sort all your friends by name.
 - **Recency** to show the friends that you frequently chat with first.

Block Friends

You can block friends from sending you messages.

1. On the friends list screen, touch the name of the friend you want to block.
2. Press **Menu**  > **Friend info** > **Block**. That friend is removed from your friends list and is added to the blocked friends list.

Unblock Friends

1. On the friends list screen, press **Menu**  > **Settings** and touch your account.
2. Touch **Blocked friends**.
3. On the blocked friends list, touch the name of the friend you want to unblock.
4. Touch **OK** to confirm.

Mobile Indicators

Mobile indicators allow you to check your friend's device.

Check Friends' Devices

You can see which phones your friends are using to chat in Google Talk.

- If “on Mobile Device” appears under your friend's name, it indicates that your friend is using an Android phone.
- If an email address is displayed, it indicates that your friend is using a computer.

Display a Mobile Indicator

You can choose to show a mobile indicator along with your name to let your friends know the type of wireless device you are using.

1. On the friends list screen, press **Menu**  > **Settings**.
2. Touch your account name and check **Mobile indicator**.

Sign Out

Follow the steps to sign out from the Google Talk.

- ▶ On the friends list screen, press **Menu**  > **Sign out** to sign out from Google Talk.

Google Talk Settings

You can manage the Google Talk settings as you like.

1. On the friends list screen, press **Menu**  > **Settings**.
2. Touch your account name and touch any of the following to change the settings.
 - **Mobile indicator:** Select to allow your friends to see the type of wireless device you are using. See [Mobile Indicators](#).
 - **Away when screen off:** Select to show your status as away when the screen is turned off.

- **Invitation notifications:** Select to show a notification in the status bar when someone invites you to become a friend.
- **IM notifications:** Select whether to open a dialog, show a notification, or do nothing when a new instant message is received.
- **Notification ringtone:** Select if you want the phone to ring when a new instant message is received. On the ringtone menu, touch a ringtone to play the tone briefly, and then touch **OK** to confirm the selection. Select **Silent** if you do not want the phone to ring when a new instant message is received.
- **Vibrate:** Select if you want the phone to vibrate when a new instant message is received.
- **Video chat notifications:** Select whether to open a dialog or to show a notification when a new voice or video chat invitation arrives.
- **Video chat ringtone:** Select if you want the phone to ring when a new voice or video chat invitation arrives. On the ringtone menu, touch a ringtone to play the tone briefly, and then touch **OK** to confirm the selection. Select **Silent** if you do not want the phone to ring when a new voice or video chat invitation arrives.
- **Vibrate:** Select if you want the phone to vibrate when a new voice or video chat invitation arrives.
- **Default video effect:** Select to set the level of the image stabilization.
- **Blocked friends:** Select to show your blocked friends list.
- **Clear search history:** Select to delete the Google Talk search history.
- **Manage account:** Select to open the Accounts & sync settings menu.
- **Terms & privacy:** Select to show the Google legal information.

Apps and Entertainment

All your phone's features are accessible through the Apps list.

Note: Available applications and services are subject to change at any time.

Google Play Store App



Google Play™ is your digital content destination to discover Android apps, books, movies, music and much more on your device and on the web. Choose from a wide variety of free and paid content ranging from productivity apps and games to bestselling books and blockbuster movies and music. When you find what you want, you can easily download and install it on your phone.

To access the Google Play Store app, you must first connect to the Internet using your phone's Wi-Fi, Sprint 4G, or data connection and sign in to your Google Account. See [Web and Data](#) and [Sign In to Your Google Account](#) for details.

Important: Sprint's policies often do not apply to third-party applications. Third-party applications may access your personal information or require Sprint to disclose your customer information to the third-party application provider. To find out how a third-party application will collect, access, use, or disclose your personal information, check the application provider's policies, which can usually be found on their website. If you aren't comfortable with the third-party application's policies, don't use the application.

Find and Install an App

When you install apps from the Google Play Store app and use them on your phone, they may require access to your personal information (such as your location, contact data, and more) or access to certain functions or settings of your phone. Download and install only apps that you trust.

1. Press **Home**  >  > **Play Store**.
2. When you open the Google Play Store app for the first time, the Terms of Service window will appear. Touch **Accept** to continue.
3. Find an app you want and touch it to open its details screen.



Note: The Google Play Store screen shots and options may vary depending on the version installed on your phone. Your Google Play Store app will update automatically when available.

4. Touch an app to read a description about the app and user reviews.
5. Touch **Install** (for free applications) or the price icon (for paid applications).

Note: You need a Google Wallet account to purchase items on Google Play. See [Create a Google Wallet Account](#) to set up a Google Wallet account if you do not have one.

6. The subsequent screen notifies you whether the app will require access to your personal information or access to certain functions or settings of your phone. If you agree to the conditions, touch **Accept & download** (for free applications) or **Accept & buy** (for paid application) to begin downloading and installing the app.

If you selected a paid application, after touching **Accept & buy**, you're redirected to the Google Wallet screen to pay for the application before it's downloaded to your phone.

Warning: **Read the notification carefully!** Be especially cautious with applications that have access to many functions or a significant amount of your data. Once you touch **OK** on this screen, you are responsible for the results of using this item on your phone.

Create a Google Wallet Account

You must have a Google Wallet account associated with your Google Account to purchase items from the Google Play Store app.

Do one of the following:

- ▶ On your computer, go to wallet.google.com to create a Google Wallet account.

– or –



The first time you use your phone to buy an item from Google Play, you're prompted to enter your billing information to set up a Google Wallet account.

Warning: When you've used Google Wallet once to purchase an application from the Google Play Store app, the phone remembers your password, so you don't need to enter it the next time. For this reason, you should secure your phone to prevent others from using it without your permission. (For more information, see [Security Settings](#).)

Request a Refund for a Paid App



If you are not satisfied with an app, you can ask for a refund within 15 minutes of the purchase, unless otherwise stated by the app developer. Your credit card is not charged and the app is uninstalled from your phone.

If you change your mind, you can install the app again, but you can't request a refund a second time.



1. Press **Home**  >  > **Play Store**.
2. Press **Menu**  > **My Apps**.
3. Touch the app to uninstall for a refund. The details screen for the app opens.
4. Touch **Refund**. Your app is uninstalled and the charge is cancelled.

Open an Installed App

There are options for opening an installed app.

- ▶ On the status bar, check if you see the  icon. If you see the  icon, open the Notifications panel, and then touch the app to open it.

– or –

1. Press **Home**  > .
2. Locate the app and touch the icon.



– or –

1. Press **Home**  >  > **Play Store**.
2. Press **Menu**  > **My Apps**.



3. Locate the app and touch it.
4. Touch **Open**.

Uninstall an App

You can uninstall any app that you have downloaded and installed from the Google Play Store app.

1. Press **Home**  >  > **Play Store**.
2. Press **Menu**  > **My Apps**.
3. On the **INSTALLED** screen, touch the app you want to uninstall, and then touch **Uninstall**.
4. When prompted, touch **OK** to remove the app from your phone.

– or –

1. Press **Home**  > **Menu**  > **System settings** > **Apps**.
2. Touch the **DOWNLOADED** tab, touch the app you want to uninstall, and then touch **Uninstall**.
3. When prompted, touch **OK** to remove the app on your phone.
4. Touch **OK**.

Get Help with Google Play

The Google Play Store app offers an online help option if you have questions or want to know more about the app.

- ▶ Press **Menu**  > **Help** and select a browser to use. The Web browser will take you to the Google Play Help Web page.

Navigation



Your phone offers a number of location-based navigation programs to help you figure out where you are and get you where you're going.

Google Maps

Use the Google Maps app to determine your location, find directions, browse local businesses and attractions, rate and review places, and more.

Enable Location Services on Your Phone

Before using any location-based services, you must enable your phone's GPS location feature. For more information about location services, see [Location Services Settings](#).

1. Press **Home**  > **Menu**  > **System settings** > **Location services**.
2. Select the check boxes for your location options.
 - **Google's location service** uses Wi-Fi and mobile networks to determine location.
 - **GPS satellites** uses GPS to provide location accurate to street level.
 - **NMEA output** enables GPS-NMEA location data output via USB cable.
 - **Location & Google search** allows Google to use your location data for improved search results and other services.
3. When prompted, touch **Agree**.

Open Google Maps

- ▶ Press **Home**  >  > **Maps**.

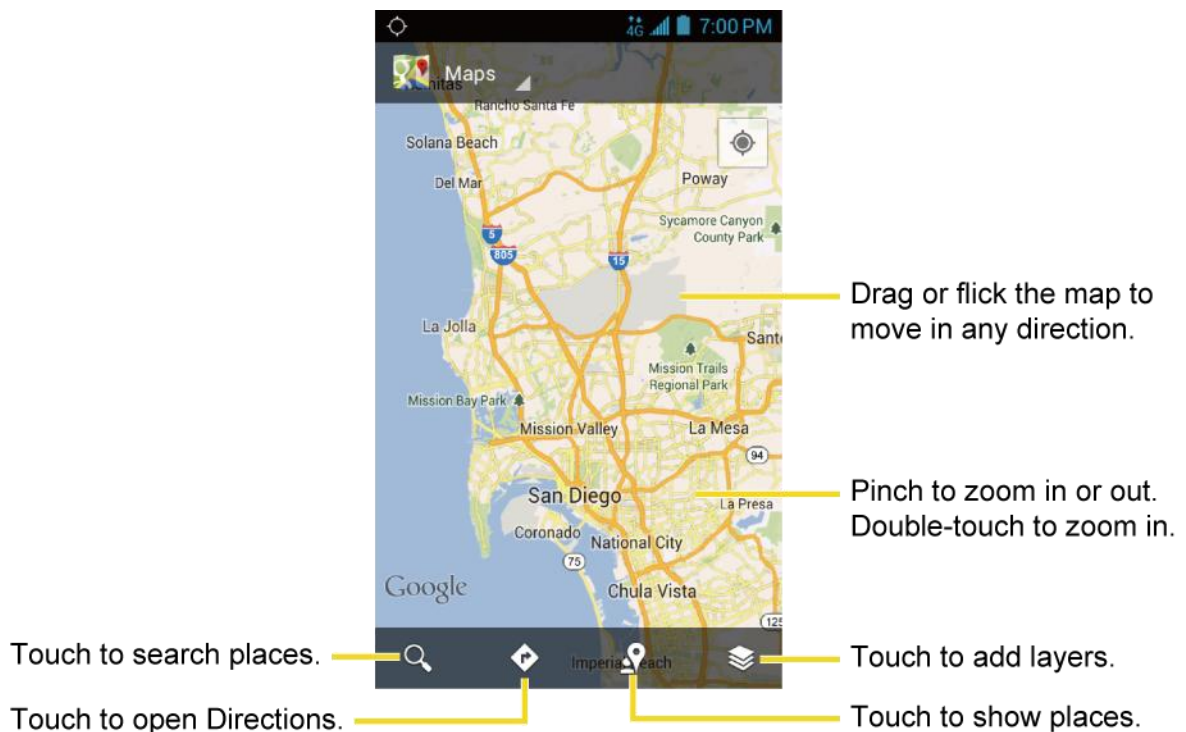

Find Your Current Location



Note: Don't forget to set your location sources.

On the Google Maps screen, touch . A blinking blue arrow indicates your current location on the map. This feature is available when **Google's location service** or **GPS satellites** is enabled. See [Enable Location Services on Your Phone](#).

Search Maps

1. On the Google Maps screen, touch .
2. Type the place that you want to search. You can enter an address, a city, or type of establishment.

Tip: Touch  to search by speaking the location you are searching.

3. Touch  or . A callout label appears on the map to indicate the location.
4. Touch the callout to open the menu for the location.



Add Map Layers

Layers allow you to view locations and additional info overlaid on the map.

To access layers, touch  while in the Maps screen. Then select **Layers**.

- **Traffic:** Add this layer to view real-time traffic conditions with roads marked in color-coded lines that indicate the traffic condition. This mode is available in selected areas only.
- **Satellite:** Add this layer to use the same satellite data as Google Earth. The images are not real-time and are approximately one to three years old.
- **Terrain:** Add this layer for a shaded relief view of topographic features.
- **Transit Lines:** Add this layer to provide geographic representations of transit lines. This mode is available in selected areas only.
- **Latitude:** Add this layer to see your friends' locations and share yours with them. You may sign in with your Google Account to use this feature.
- **My Maps:** Adds this layer to display Google My Maps on Google Maps of your phone.
- **Bicycling:** Adds this layer to provide the road map suitable for bicycling.
- **Wikipedia:** Adds this layer to provide a list of Wikipedia articles that are geo-referenced. An extract of the Wikipedia article can be accessed by clicking on the icon, a link to the full version of the Wikipedia article is also available.

Get Directions

1. On the Google Maps screen, touch .
2. Do one of the following:
 - The starting point is set to your current location as default. Touch  to change your starting point place.
 - Touch **End point:** and type your destination or touch  to select the destination from the list.
3. Select the way to get to the destination (by car, by train, or by foot).
4. Touch **GET DIRECTIONS**. The directions to your destination appear in a list or on the map. Touch **NAVIGATION** to open Google Navigation to navigate you to your destination.

Clear the Map



When you have reached your destination, press **Menu**  > **Clear Map** to reset the map.

Scout™ by Telenav

Scout™ by Telenav is a daily personal navigator that helps you get where you're going. It lets you see and hear turn-by-turn directions and it can provide important, personalized information about traffic and alternate routes.

Install the Scout App on Your Phone





Before you use Scout on your phone, you must download and install the app from the Google Play Store app.

1. Press **Home**  >  > **Play Store**.
2. Touch the Search icon and search for "scout."
3. Touch **Scout by Telenav** from the results list.
4. Touch **Install**, and then touch **Accept & download**.
5. When the download has completed, tap **Open**. To open the app from the home screen, touch  > **Scout**.

Enable Location Services on Your Phone



Before using any location-based services, you must enable your phone's GPS location feature. For more information about location services, see [Location Services Settings](#).

Use Scout as Your Personal Navigator

1. Press **Home**  >  > **Scout**.
2. When you open the Scout app for the first time, the Terms of Use window will appear. Touch **Accept** to continue.
3. Enter your wireless phone number and touch **Continue**.
4. When the setup process is finished, the Dashboard screen appears.
 - Touch **Set Up Home**, enter your home address and touch **Submit**. The time from your current location to the entered address will appear under **Time to Home**.
 - Touch **Set Up Work**, enter your work address and touch **Submit**. The time from your current location to the entered address will appear under **Time to Work**.
 - Touch **Places** and select a category. The matching information for the category appears.
 - Touch **Drive** and enter an address or touch a category to specify your destination. The route from your current location appears. Touch **Directions** to display a turn-by-turn directions.
 - Touch **Maps** and enter an address to see the location on a map. If available, touch **Drive To** to get directions to the place, **Call** to call the place, or **Share** to share the information.
 - Touch  to activate the voice navigation service. Read the examples and say a command to get spoken turn-by-turn directions to guide you to your destination.
 - Touch **Extras** or press **Menu**  > **Settings** to configure Scout's settings.

Google Navigation

Google Navigation uses your current location (provided by GPS communication to your phone) to provide various location-based services.

1. Press **Home**  >  > **Navigation**.
2. Read the onscreen disclaimer and touch **Accept**, if you agree.
3. Choose from the following onscreen options:
 - **SHORTCUTS** tab:
 - **Speak destination** to use the voice recognition feature to search for matching locations.

- **Type destination** to manually enter a destination address.
- **Go home** to show the route guidance to your home.
- **Map** to open the Map application.
- **RECENT DESTINATIONS** to display a recently searched route.
- **STARRED** tab: to obtain directions to the locations that have been starred within Google Maps (maps.google.com).
- **CONTACTS** tab: to receive turn-by-turn directions to the address stored for a selected contacts entry.



Google Latitude

Google Latitude™ user location service lets you and your friends share locations and status messages with each other. It also lets you send instant messages and emails, make phone calls, and get directions to your friends' locations.

Your location is not shared automatically. You must join Latitude, and then invite your friends to view your location or accept their invitations.





Open Latitude

To join Latitude:

1. Press **Home**  >  > **Latitude**.
2. A description of Location Sharing will appear. To continue, touch **Share location with family or friends**.
3. Read the privacy policy. If you agree with it, touch **Agree & Continue**.

After you join Latitude, you can start sharing your locations with your friends. Only friends that you have explicitly invited or accepted can see your location.

To open Latitude after joining:

1. Press **Home**  >  > **Latitude**.
2. Select the following options.
 - Touch **MAP VIEW** to see your friend on Google Maps.
 - Touch  to invite your friend to Latitude.
 - Touch  to sign in Latitude.
 - Touch  to refresh the friend list.

- Press **Menu**  > **Location settings** > **Location reporting** to configure your location reporting and sharing.

Invite Friends

To share your location with friends and request to see their locations:

1. In Latitude, touch .
2. Choose how to add friends:
 - **Select from Contacts:** Select any number of friends from contacts.
 - **Add via email address:** Enter an email address and touch Add friends.
3. Confirm your friend is checked and touch **Yes**.

If your friends already use Latitude, they receive an email request and a notification on Latitude. If they have not yet joined Latitude, they receive an email request that tells them to sign in to Latitude with their Google Account.

Accept an Invitation

When you get a sharing request from a friend, you see "... new sharing requests" message. Touch it and you can:

- **Accept and share back:** You can see your friends' locations, and they can see yours.
- **Accept, but hide my location:** You can see your friends' locations, but they can't see yours.
- **Don't accept:** No location information is shared between you and your friends.

You can change how your location is shared with each friend at any time. See [Connect with Your Friends](#) for details.

Show Your Friends

You can show your friends using the map view or the list view.

Map View:

Touch **MAP VIEW** on the Latitude screen. Google Maps™ shows your friends' locations. Each friend is represented by a photo icon with an arrow pointing at his or her approximate location. If a friend has opted to enable city-level sharing, his or her icon will not have an arrow and it appears in the middle of the city. See [Connect with Your Friends](#) for more details.

To see your friend's profile and connect with him or her, touch the photo. This will display your friend's name, and then touch the balloon right above his or her icon.

List View:

To show a list of your friends, in Google Maps, touch **FRIENDS LIST**.

To see a friend's profile and connect with him or her, select your friend's name from the list.

Connect with Your Friends



Touch a friend's contact details balloon in map view or touch a friend in list view to open the friend's profile. In the profile screen, you can communicate with your friend and set privacy options.

- **Map:** Find a friend's location on the map.
- **Directions:** Get directions to the friend's location.
- **Ping for check in:** Send this friend a notification asking them to check in.
- **Manage sharing:** Select from the following:
 - **Share best available location:** Share your precise location information.
 - **Share only city level location:** Share only the city you are in, not the street-level location. Your friend can see your photo icon in the middle of the city you are in. To share more precise location again, touch **Share best available location**.
 - **Hide from this friend:** Stop sharing your location with this friend, both in list view and in map view.
- **Remove this friend:** Remove the friend from your list and stop sharing locations with him or her altogether.

Change Privacy Settings

You have control over how and when you can be found by your friends. Only the last location sent to Latitude is stored with your Google Account. If you turn off Latitude or are hiding, no location is stored.

To change your public profile:

1. Press **Home**  >  > **Latitude**.
2. Touch your own name, and then touch **Location settings**.
– or –
Press **Menu**  > **Location settings**.
3. Set the following options to your preferences.

- **Location reporting:** Let Latitude detect and update your location as you move. The update frequency is determined by several factors, such as how recently your location has changed.
- **Report from this device:** Automatically update your location from your phone.
- **Enable location sharing:** Share your location with the people you choose.
- **Manage your friends:** Add or remove friends who can see your location.
- **Enable location history:** Store your past location and visualize them on the Latitude website.
- **Automatic check-ins:** Check you into places you have designated.
- **Check-in notifications:** Enable notifications that suggest places to check in.
- **Manage your places:** View and modify your automatic check-ins and muted places.

Music Player

The Play Music app plays digital audio files saved on the storage card. You need to copy music files to your storage card first to use the Music application. See [Use the Phone's microSD Card as a USB Drive](#) for more details on copying files.

Note: If you have signed up for Google Music™, the first time you open the Music application you will be prompted to select the account whose online music library you want to access from the Android Music application. Follow the onscreen instructions to continue.

Open the Music Library

Access the music library to enjoy your favorite music.

- ▶ Press **Home**  >  > **Play Music**. The Music library screen appears.

Play Music

Learn the basics to use the Music application.





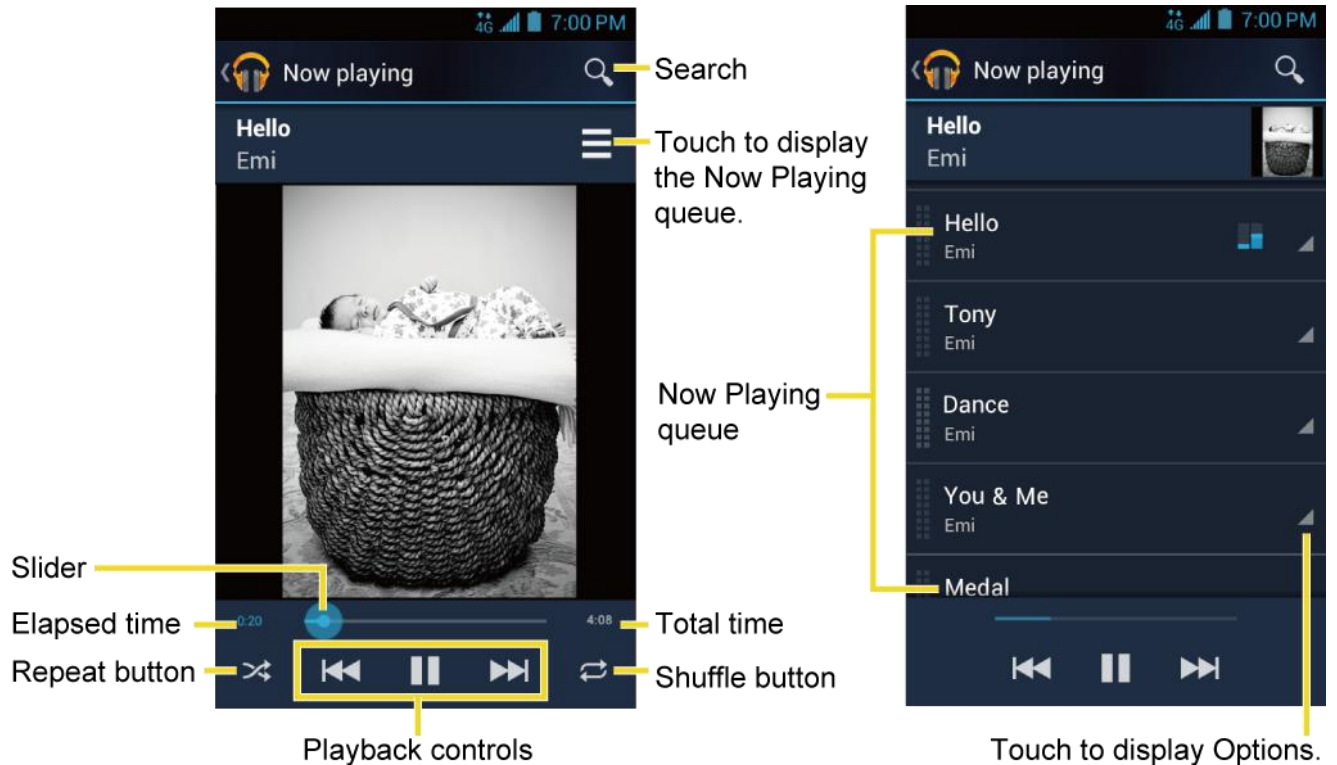

1. On the Music library screen, touch a category name to view its contents. Available categories are:
 - **PLAYLISTS** to select a customized playlist you've created.
 - **RECENT** to show the albums you have listened to recently.
 - **ARTISTS** to show your music library sorted by artist.
 - **ALBUMS** to show your music library sorted by album.
 - **SONGS** to list all of your songs in alphabetical order.

- **GENRES** to show your music library sorted by genre.
2. Touch a song in your library to play it. The Now playing screen opens.
 - or –
 - Touch the triangular menu button  next to an item and touch **Play**.

Now Playing Screen



The following options are available for the control:

- Drag the slider to rewind or fast-forward.
- Touch  to pause. Touch  to resume playing.
- Touch  to go back to the start of the currently played piece. Touch  to jump to the start of the next piece.
- Touch  to toggle shuffle on or off.
- Touch  to cycle through the repeat modes: **Repeating all songs**, **Repeating current song**, or **Repeat is off**.

While using the Music application you can touch the triangular menu button  next to any song, album, artist, or playlist to view additional options. These options may vary depending on the music data.

- **Play** to play the song.
- **Play next** to play the song next.
- **Add to queue** to add the song to the queue.
- **Add to playlist** to add the song to the playlist.
- **Remove from queue** to remove the song from the queue.
- **More by artist** to show another album of the selected artist.
- **Shop for artist** to open the browser and find items related to the artist.
- **Delete** to delete the song.

Tip: For more options such as changing the settings, clearing or saving the queue, or displaying equalizer, press **Menu** .

Search for Music in the Music Library.

Follow the instructions to find music in your Music library.

1. Open the Music library and touch the Search icon .
2. Start typing the name of the artist, album, song, or playlist you're looking for. As you type, matching information is displayed on the screen.
3. To select a matched item, touch the item.

Now Playing Queue.

The Now Playing queue allows for queuing and reordering of the music.

Display the Now Playing Queue

- ▶ On the Now Playing screen, touch . See [Now Playing Screen](#).

Add an Item to the Queue

1. Open the Music library and identify the item you want to add to the queue.
2. Touch  next to the item and touch **Add to queue**.

Remove an Item from the Queue

1. On the Now Playing queue screen, identify the item you want to remove from the queue.
2. Touch  next to the item and touch **Remove from queue**.

Save the Queue

1. On the Now playing queue screen, press **Menu**  > **Save queue**.
2. Enter the name to be displayed in the playlist and touch **OK**. The queue is saved as a playlist.

Clear the Queue

- ▶ On the Now playing queue screen, press **Menu**  > **Clear queue**.

Reorder the Queue

- ▶ On the Now playing queue screen, touch  next to the item you want to play the next and then touch **Play next**. The music will be played the next.

Use Playlists

Create and manage a playlist to organize your music.

Create a Playlist

1. Open the Music library and browse for the song that you want to add to the playlist.
2. Touch  next to the song you want to add and touch **Add to playlist**.
3. On the Add to playlist window, touch **New playlist**.
4. Type the name of your new playlist and touch **OK**. After you save the playlist, it's added to the Playlists library.

Add an Item to an Existing Playlist

1. Open the Music library and browse for the song that you want to add to the playlist.
2. Touch  next to the song you want to add and touch **Add to playlist**.
3. On the Add to playlist window, touch the name of the playlist that you want to add the song to.

Remove an Item from a Playlist

1. Open the Playlists library.

2. Touch the playlist that contains the music you want to remove.
3. Touch  next to the song you want to remove and touch **Remove from playlist**.

Rename a Playlist

1. Open the Playlists library.
2. Touch  next to the playlist you want to rename and touch **Rename**.
3. Type the new name of the playlist and touch **Rename**.

Play an Item in a Playlist

1. Open the Playlists library.
2. Touch  next to the song you want to play and touch **Play**.

Delete a Playlist

1. Open the Playlists library.
2. Touch  next to the playlist you want to delete and touch **Delete**.
3. Touch **OK** to confirm.

Back Up Your Downloaded Music Files

Sprint recommends you back up your downloaded music files to your computer. Although the downloaded files can only be played on your phone and on your account, backing them up to your computer lets you access the files in case your microSD card is lost or damaged, or if you install a new microSD card. See [microSD Card](#).

1. Connect your phone to your computer using a USB cable.
2. Use your computer to navigate to the microSD card's Music folder.
3. Select and copy the music files to a folder on your computer's hard drive.

Sprint ID



ID Packs are bundles of applications, ringtones, wallpapers, settings, and more. ID Packs are installed using an application called Sprint ID.

You can install as many as five ID Packs at any one time in addition to the default My ID Pack. You can easily switch from one ID Pack to another without losing any applications already installed. For example, when you install the Sprint pack, Sprint applications such as Sprint TV & Movies, Scout by TeleNav, and NASCAR Sprint Cup Mobile will remain in your applications.

Install Your ID Pack

A variety of ID Packs are available. Select your favorite pack and install it.

Note: Your phone must be activated, your battery should be fully charged, and you should be in a network coverage area before you install an ID Pack.



1. Press **Home**  > .
2. Touch **Get New ID Packs** on the **Choose your ID** screen.
3. Touch an ID Pack on the **Get New ID Packs** screen.
4. Read the information screen for a description of the ID Pack and touch **Install**.
5. Read the Terms & Conditions and touch **Agree** to begin the download.
6. Wait for the download to finish and the ID Pack will then begin installation automatically.

– or –

Touch **Continue** to continue using your phone. When the notification icon appears, slide the status bar down, and touch ID ready to install to complete the installation.

Switch ID Packs

You can switch to an installed ID Pack or install a new one.

1. Press **Home**  > .
2. Touch an ID Pack to replace your current pack.

– or –

Touch **Get New ID Packs** to install a new ID Pack and follow steps 3-6 of [Install Your ID Pack](#).

Note: Certain features of Sprint ID are subject to change. For the most up-to-date information about using Sprint ID, please visit sprint.com.



Sprint TV & Movies

With Sprint TV & Movies, you can watch live TV and access movies and other on demand entertainment on the go.



Your Sprint TV Channel Options

The Sprint TV & Movies application offers a wide variety of accessible channels. Subscription options include comprehensive basic packages as well as a full menu of “a la carte” channels. Visit sprintchannels.mobitv.com for more information on channels and pricing.

Note: Available categories and content are subject to change. Visit sprintchannels.mobitv.com for more information on channels and pricing.

Note: If Sprint TV & Movies isn't already installed on your phone, you can download it from Sprint Zone: Press **Home**  >  > **Sprint Zone** > **Sprint SUGGESTS** and scroll down to Sprint TV & Movies under the Sprint Applications tab.

Watch TV

1. Press **Home**  >  > **Sprint TV & Movies**. Depending on your settings, your phone may prompt you to accept a data connection.

Note: Sprint TV can only be viewed over a cellular connection. Turn off your Wi-Fi communication prior to using this application. If prompted, touch **Disable Wi-Fi** to continue.

2. Select **Live TV**, **On Demand**, **Movies**, **Shops**, or **Help** to display channel options.
3. Touch an entry to select a channel from the Sprint TV listings or to select an available category.



Note: The first time you access a channel, the system will prompt you to purchase access (unless the channel doesn't have a monthly fee). Touch **Subscribe** to purchase access, or touch **Preview** to see a preview of the selected channel.

4. Touch a clip to view the program. The clip will automatically load and begin playing.

Tip: Scroll through the channels to view more selections. Once you find a channel that you want to watch or listen to, simply touch it and wait approximately three seconds, and the channel begins loading.

Sprint Zone

Sprint Zone is a free application which helps you manage your account, get tips and tricks for your phone, find recommended apps, and more.

1. Press **Home**  >  > **Sprint Zone**.
2. From the Sprint Zone Web page, scroll up or down and touch an item to check your account, read the latest news about your phone, load an application, and more.

Currently, various applications, such as NASCAR, Scout by TeleNav, and Sprint TV & Movies are available through Sprint Zone. Access Sprint Zone for the latest information.

Web and Data

Your phone's data capabilities let you wirelessly access the Internet or your corporate network through a variety of connections, including Wi-Fi, Sprint 4G, Data Services (Sprint 3G Network), and Virtual Private Networks (VPN).

The following topics address your phone's data connections and the built-in Web browser. Additional data-related features can be found in [Accounts and Messaging](#), [Apps and Entertainment](#), and [Tools and Calendar](#).

Wi-Fi

Wi-Fi provides wireless Internet access over distances of up to 300 feet. To use your phone's Wi-Fi, you need access to a wireless access point or "hotspot."

The availability and range of the Wi-Fi signal depends on a number of factors, including infrastructure and other objects through which the signal passes.

Turn Wi-Fi On and Connect to a Wireless Network

Use the Wireless & networks setting menu to enable your phone's Wi-Fi radio and connect to an available Wi-Fi network.

1. Press **Home**  > **Menu**  > **System settings** > **Wi-Fi**.
2. If the off icon  is displayed next to Wi-Fi, touch it to turn Wi-Fi on. The on icon  is displayed and the phone will scan for available wireless networks.
3. Touch **Wi-Fi**. The network names and security settings (open network or secured with WEP/WPA/WPA2 PSK) of detected Wi-Fi networks are displayed.
4. Touch a Wi-Fi network to connect. If you selected an open network, you will be automatically connected to the network. If you selected a network that is secured with a password, enter the password and then touch **Connect**.

Depending on the network type and its security settings, you may also need to enter more information or choose a security certificate.

When your phone is connected to a wireless network, the Wi-Fi icon () appears in the status bar and tells you the approximate signal strength. (The above icon indicates maximum signal strength.)



If **Network notification** in Advanced Wi-Fi settings is enabled, this icon () appears in the status bar whenever the phone detects an available open wireless network within range.

Note: The next time your phone connects to a previously accessed secured wireless network, you will not be prompted to enter the password again, unless you reset your phone to its factory default settings or you instruct the phone to forget the network.

Note: Wi-Fi networks are self-discoverable, which means no additional steps are required for your phone to connect to a Wi-Fi network. It may be necessary to provide a user name and password for certain closed wireless networks.

Check the Wireless Network Status



Check the status of your current wireless network, including speed and signal strength, through the Wi-Fi settings menu.

1. Press **Home**  > **Menu**  > **System settings** > **Wi-Fi**.
2. Touch the wireless network that the phone is currently connected to. You will see a message box showing the Wi-Fi network name, status, speed, signal strength, and other details.

Note: If you want to remove the phone's wireless network settings, touch **Forget** on this window. You need to enter the settings again if you want to connect to this wireless network.

Connect to a Different Wi-Fi Network

Use the Wireless & networks settings to scan for and connect to a different Wi-Fi network.

1. Press **Home**  > **Menu**  > **System settings** > **Wi-Fi**. Detected Wi-Fi networks are displayed in the Wi-Fi networks section. To manually scan for available Wi-Fi networks, touch **SCAN**.
2. Touch another Wi-Fi network to connect to it.

Note: If the wireless network you want to connect to is not in the list of detected networks, touch **ADD NETWORK**. Enter the wireless network settings and touch **Save**.



Sprint Connections Optimizer

The Sprint Connections Optimizer is a tool that automatically selects the best mobile network for your phone, including "remembered" Wi-Fi networks.



The Sprint Connections Optimizer helps you manage and enhance your data experience by finding and connecting to "remembered" Wi-Fi networks on your phone. Remembered Wi-Fi networks are networks with which you have previously chosen to connect. Active Wi-Fi connections may offer improved performance and generally improve battery life while allowing you to talk on the phone and use data at the same time. The Sprint Connections Optimizer works by searching for available "remembered" Wi-Fi networks.

If you do not leave your Wi-Fi antenna on all the time, you will only notice the Sprint Connections Optimizer operating at certain times of the day in a small number of locations on the Sprint network. Your Wi-Fi antenna will conserve battery by scanning for connections periodically (not continuously), and if no connection is achieved, the antennas will be turned off. You may also manually turn the antennas off during the scan period. To facilitate quality assurance and enable feature enhancements, information is collected about your battery levels, Wi-Fi and Sprint Network connections and usage. No personal information is collected.

Enable Sprint Connections Optimizer

1. Press **Home**  > **Menu**  > **System settings** > **More...** > **Mobile networks** > **Connections Optimizer**. You will see a disclaimer.
2. Read the disclaimer and touch **I Agree** to turn Sprint Connections Optimizer on.

Disable Sprint Connections Optimizer

1. Press **Home**  > **Menu**  > **System settings** > **More...** > **Mobile networks** > **Connections Optimizer**.
2. Uncheck the box on the Sprint Connections Optimizer page.

Sprint 4G

Sprint 4G provides your phone with wireless Internet access over greater distances than Wi-Fi and delivers data transfer rates of up to 30 Mbps. To connect your phone to Sprint 4G network, you need access to a Sprint 4G base station.

For more information about the availability of Sprint 4G in your location, visit sprint.com/coverage.



Note: The availability and range of the Sprint 4G depends on a number of factors including your distance to the Sprint 4G base station, and infrastructure and other objects through which the signal passes.

When You Do Not Subscribe to Sprint Direct Connect Services

Your phone is in LTE/CDMA mode by default. The phone will scan for the Sprint 4G network and will automatically connect to it when it is available.

When You Subscribe to Sprint Direct Connect Services

When you subscribe to Sprint Direct Connect services, you have an option to select the network mode.

1. Press **Home**  > **Menu**  > **System settings** > **More...** > **Mobile networks** > **Network mode**.

2. Select an option:

- **LTE/CDMA:** The phone will connect to LTE or CDMA. The Direct Connect services will be disabled in LTE/CDMA mode. Read the message, if it appears, and touch **OK**. The phone will scan for the Sprint 4G network and will automatically connect to it when it is available.
- **CDMA only:** The phone will connect to CDMA only.

When your phone is connected to the Sprint 4G network, the 4G icon () appears in the status bar.

Note: The Sprint 4G network is self-discoverable, which means no additional steps are required for your phone to connect to it.

Data Services (Sprint 3G and 4G Networks)

The following topics will help you learn the basics of using your data services, including managing your user name, launching a data connection, and navigating the Web with your phone.

Important: Certain data services requests may require additional time to process. While your phone is loading the requested service, the touchscreen may appear unresponsive when in fact they are functioning properly. Allow the phone some time to process your data usage request.

Your User Name

When you buy your phone and sign up for service, you're automatically assigned a user name, which is typically based on your name and a number, followed by "@sprintpcs.com." (For example, the third John Smith to sign up for Sprint data services might have jsmith003@sprintpcs.com as his user name.)

When you use data services, your user name is submitted to identify you to the Nationwide Sprint Network. Your user name is automatically programmed into your phone. You don't have to enter it.



Update Your User Name

If you choose to change your user name and select a new one online, or make any changes to your services, you must then update the profile on your phone.

1. Press **Home**  > **Menu**  > **System settings** > **System update**.
2. Touch **Update profile**.

Launch a Web Connection

Launching a Web connection is as simple as opening the browser on your phone.

- ▶ Press **Home**  >  > **Browser**. (Your data connection starts and you see the home page.)

Note: Internet connections can be made either through the Sprint (3G or 4G) or via Wi-Fi (configured within the **Settings > Wi-Fi** page).

Tip: To change the phone's default launch page to your current page, press **Menu**  > **Settings > General > Set homepage > Current page**. See [Set the Browser Home Page](#) for details.

Note: The Browser automatically launches when a Web link is touched from within either an email or text message.

Data Connection Status and Indicators

Your phone displays the current status of your data connection through indicators at the top of the screen. The following symbols are used:



Your phone is connected to the high-speed 4G Sprint Mobile Broadband Network. When the arrows are animated, your phone is transferring data (for example, when you are opening a Web page); when the arrows are gray, your phone is connected to the network but is not currently transferring data (for example, when you are viewing a Web page that is completely open). In either state, you can receive incoming calls.



Your phone is connected to the high-speed Sprint Mobile Broadband Network (3G). When the arrows are animated, your phone is transferring data (for example, when you are opening a Web page); when the arrows are gray, your phone is connected to the network but is not currently transferring data (for example, when you are viewing a Web page that is completely open). In either state, you can receive incoming calls.

If you do not see an indicator, your phone does not have a current data connection. To launch a connection, see [Launch a Web Connection](#).

Virtual Private Networks (VPN)

From your phone, you can add, set up, and manage virtual private networks (VPNs) that allow you to connect and access resources inside a secured local network, such as your corporate network.



Prepare Your Phone for VPN Connection

Depending on the type of VPN you are using at work, you may be required to enter your login credentials or install security certificates before you can connect to your company's local network. You can get this information from your network administrator.

Before you can initiate a VPN connection, your phone must first establish a Wi-Fi or data connection. For information about setting up and using these connections on your phone, see [Launch a Web Connection](#) and [Turn Wi-Fi On and Connect to a Wireless Network](#).



Install Security Certificates

Your network administrator may instruct you to download and install security certificates to connect to the network.

1. Download and install the certificates needed to access your local network into a microSD card. Your network administrator can tell you how to do this.
2. Insert the microSD card into your phone. See [Insert a microSD Card](#).
3. Press **Home**  > **Menu**  > **System settings** > **Security** > **Install from SD card**, and install the necessary security certificates.

Add a VPN Connection

Use the Wireless & networks settings menu to add a VPN connection to your phone.



1. Press **Home**  > **Menu**  > **System settings** > **More...** > **VPN**.
2. If you are asked to set up a screen lock, touch **OK** and set up a required type of lock. To set up a screen lock, see [Screen Lock](#).
3. Touch **Add VPN network**, and then enter the information for the VPN you want to add.
 - Information may include Name, Type, Server address, PPP encryption (MPPE), and advanced options.
 - Set up all options according to the security details you have obtained from your network administrator.
4. Touch **Save**.

The VPN is then added to the VPNs section of the VPN settings screen.

Connect to or Disconnect from a VPN

Once you have set up a VPN connection, connecting and disconnecting from the VPN is easy.

Connect to a VPN

1. Press **Home**  > **Menu**  > **System settings** > **More...** > **VPN**.
2. In the VPNs section, touch the VPN that you want to connect to.
3. When prompted, enter your login credentials, and then touch **Connect**. When you are connected, a VPN connected icon appears in the notification area.
4. Open the Web browser to access resources such as intranet sites on your corporate network. (For more information about browsing the Web, see [Learn to Navigate the Browser](#).)

Disconnect from a VPN

1. Drag the status bar down to open the Notifications panel.
2. Touch the VPN connection to return to the VPN settings screen, and then touch the VPN connection to disconnect from it.

When your phone has disconnected from the VPN, you will see a VPN disconnected icon in the notification area of the title bar.

Browser

Your phone's Web browser gives you full access to both mobile and traditional websites on the go, using 3G, 4G, or Wi-Fi data connections.

Launch the Web Browser

Launching the browser is as easy as touching an icon.

- ▶ Press **Home**  >  > **Browser**.

Learn to Navigate the Browser

Navigating through menus and websites during a data session is easy once you have learned a few basics.

Note: Before you access the SprintWeb home page, you may be asked to enter your 10-digit wireless phone number and touch **OK**. Entering your phone number is not required for access to other Web pages.

Scrolling

As with other parts of your phone's menu, you'll have to drag up and down to see everything on some websites.

To scroll through a website's page:

- ▶ In a single motion, touch and drag across or up and down a page.

Selecting

To select onscreen items or links:

- ▶ Drag across a page, and then touch an item or onscreen link.

Links, which are displayed as underlined text, allow you to jump to Web pages, select special functions, or even place phone calls.

Pinching and Zooming

Zooming in and out on a Web page can be done now without the need of an onscreen zoom tool. Just use your fingers to pinch in or spread out on the screen.

To zoom in:

1. Place your thumb and index finger on the screen.
2. Expand them outward (spread) to zoom in.

To zoom out:

1. Place your thumb and index finger on the screen.
2. Bring them together (pinch) to zoom out.

Go Back

To go back one page:

- ▶ Press **Back**  on your phone. Repeat this process to keep going back through your Web page history of recently visited pages.

Go to a Web Page

1. Touch the Address field (top of the browser window) and enter a new Web address.
 - As you enter the address, possible matches are displayed within an onscreen list. Touch an entry to launch the desired website.
2. Touch **Go** or **Go** to launch the new page.

Browser Menu

The browser menu offers additional options to expand your use of the Web on your phone.

Open the Browser Menu

The browser menu may be opened anytime you have an active data session, from any page you are viewing.



1. Press **Home**  >  > **Browser**.
2. From any open Web page, press **Menu** . You will see the browser menu.

Options available within the browser menu may include:

- **Stop:** Stops loading the current Web page.
- **Refresh:** Reloads the current Web page.
- **Forward:** Returns you to a previously viewed page.
- **Bookmarks:** Allows you to access and manage your bookmarks.
- **Save to bookmarks:** Adds the currently viewed page to bookmarks.
- **Share page:** Allows you to share the URL via Gmail, SMS, Email, or Bluetooth.
- **Find on page:** Allows you to search in the current page.
- **Request desktop site:** Allows you to assign the browser to display the current page in the desktop view (to closely mimic the display as it would appear on a Desktop computer).
- **Save for offline reading:** Saves the Web page so you can read it later even when offline.
- **Settings:** Allows you to modify your Web settings. For more information, see [Adjust Browser Settings](#).

Select Text on a Web Page

You can highlight text on a Web page and copy it, search for it, or share it.

1. Press **Home**  >  > **Browser** and navigate to a Web page.
2. Touch and hold the text you want to copy. Drag the tabs to expand or reduce the range of the selected text. Any selected text will appear highlighted.

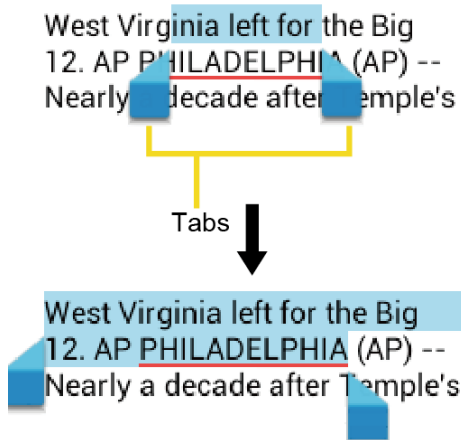



Tip: Touch **SELECT ALL** to select all the text on the Web page.

3. Touch  and select an option:
 - **Copy** to copy the selected text.
 - **Share** to share the selected text via Bluetooth, Gmail, or messaging, etc.
 - **Find** to search for all instances of the selected text in the current Web page.
 - **Web Search** to launch a Web search for the selected text.

Go to a Specific Website



Follow the instructions to go to a particular website by entering a URL (website address).

1. Touch the **URL** field and enter a website address.
 - As you type the address, if your desired website appears within the suggested sites list, touch the entry to begin surfing.
2. Touch  or .

Note: Not all websites are viewable on your phone.

Adjust Browser Settings

You can control many of the settings for your browser through the browser settings menu, including general page settings, privacy & security, accessibility settings, advanced settings such as JavaScript and plug-ins, bandwidth management, and labs settings.

1. Press **Home**  >  > **Browser**.
2. From any open Web page, press **Menu**  > **Settings**. You will see the browser settings menu.

3. You can access the following settings menus:

- **General**

- **Set homepage:** Sets the current home page for the Web browser.
- **Form auto-fill:** Fills out web forms with a single touch.
- **Auto-fill text:** Sets up text to auto-fill in web forms.

- **Privacy & security**

- **Clear cache:** Deletes all currently cached data. Touch **OK** to complete the process.
- **Clear history:** Clears the browser navigation history. Touch **OK** to complete the process.
- **Show security warnings:** Notifies you if there is a security issue with the current website. Clear the check mark to disable this function.
- **Accept cookies:** Allows sites that require cookies to save and read cookies from your phone.
- **Clear all cookie data:** Clears all current browser cookie files.
- **Remember form data:** Allows the phone to store data from any previously filled-out forms. Clear the check mark to disable this function.
- **Clear form data:** Deletes any stored data from previously filled out forms. Touch **OK** to complete the process.
- **Enable location:** Allows sites to request access to your current location (using the built-in GPS function).
- **Clear location access:** Clears location access for all websites. Touch **OK** to complete the process.
- **Remember passwords:** Stores user names and passwords for visited sites. Clear the check mark to disable this function.
- **Clear passwords:** Deletes any previously stored usernames or passwords. Touch **OK** to complete the process.

- **Accessibility**



- **Force enable zoom:** Overrides a website's request to control zoom behavior.
- **Text scaling:** Changes text size as you see on its preview screen.

- **Zoom on double-tap:** Sets the zoom magnification when you double-tap the screen.
- **Minimum font size:** Sets the minimum font size on the Web as you see on its preview screen.
- **Inverted rendering:** Inverts the screen image. Black becomes white and vice versa.
 - **Contrast:** When **Inverted rendering** is enabled, you can set the contrast using the slider.
- **Advanced**
 - **Set search engine:** Sets the search engine.
 - **Open in background:** New pages are launched in a separate page and displayed behind the current one. Clear the check mark to disable this function.
 - **Enable JavaScript:** Enables JavaScript for the current Web page. Without this feature, some pages may not display properly. Clear the check mark to disable this function.
 - **Enable plug-ins:** Allows you to determine the way your phone handles program enhancements. Select **Always on**, **On demand**, or **Off**.
 - **Website settings:** Allows you to configure advanced settings for individual websites.
 - **Default zoom:** Sets the default browser viewing size. Choose from: **Far**, **Medium**, or **Close**.
 - **Open pages in overview:** Provides an overview of the recently opened pages.
 - **Auto-fit pages:** Allows Web pages to be resized to fit as much of the screen as possible.
 - **Block pop-ups:** Prevents pop-up advertisements or windows from appearing onscreen. Clear the check mark to disable this function.
 - **Text encoding:** Adjusts the current text encoding.
 - **Reset to default:** Resets the browser settings to default.
- **Bandwidth management**
 - **Search result preloading:** Allows browser to preload high confidence search results in the background.
 - **Load images:** Displays images on Web pages.

- **Labs**
 - **Quick controls:** Opens the Quick controls and hide application and URL bars.
 - **Fullscreen:** Enables the full screen mode and hide the status bar.

Create Website Settings

You can create settings for individual websites.

1. Press **Home**  >  > **Browser**.
2. From any open Web page, press **Menu**  > **Settings** > **Advanced** > **Website settings**.
3. Touch the website you want to create the settings of. These advanced settings can be configured for individual sites.
4. Touch the settings (for example, **Clear stored data**) to complete the process.



Reset the Browser to Default

You always have the option to restore your browser to its default settings.

1. Press **Home**  >  > **Browser**.
2. From any open Web page, press **Menu**  > **Settings** > **Advanced** > **Reset to default**.
3. Touch **OK** to complete the process.

Set the Browser Home Page

Customize your Web experience by setting your browser's home page.



1. Press **Home**  >  > **Browser**.
2. From any open Web page, press **Menu**  > **Settings** > **General** > **Set homepage**.
3. Select an option to set your browser's home page.
 - **Current page** to set the current page as the home page.
 - **Blank page** to set a blank page as the home page. It helps new Browser windows to open more quickly.
 - **Default page** to set a factory default URL as home page.
 - **Most visited sites** to select a home page from a list of recently visited sites.

- **Other** to enter a specific website address for your home page. Touch **OK** to complete the process.



Create Bookmarks

Make browsing easier by setting up and using custom bookmarks.



View Bookmarks

1. Press **Home**  >  > **Browser**.
2. From any open Web page, press **Menu**  > **Bookmarks**. Three tabs are revealed:
 - **BOOKMARKS:** Displays a list of your current Web bookmarks.
 - **HISTORY:** Displays a record of your browsing history. These records are organized into folders such as: **Today**, **Yesterday**, **Last 7 days**, and **Most visited**.
 - **SAVED PAGES:** Displays a list of websites you saved for offline reading. Touch an entry to launch the selected page.

Create Bookmarks



1. Press **Home**  >  > **Browser**.
2. Open the Web page you want to bookmark and press **Menu**  > **Save to bookmarks**.
3. Enter a descriptive name for the new bookmark.
4. Select an account you want to add the bookmark to
5. Select where to save the bookmark and touch **OK**.

Create Bookmarks from History Tab

1. Press **Home**  >  > **Browser** > **Menu**  > **Bookmarks**.
2. Touch the **HISTORY** tab.
3. Locate the Web page you want to bookmark and touch the star icon next to it.
4. Edit the necessary info and touch **OK**.

Create a New Homepage



Select any previously visited Web page to display as your home page.

1. Press **Home**  >  > **Browser** > **Menu**  > **Bookmarks**.
2. Touch and hold an entry from the list to display an onscreen popup menu.

3. Touch **Set as homepage** to assign the selected entry as your new homepage.

Add Bookmarks to Your Home Screen



You can add Web bookmarks to your phone's home screen for quick access.

1. Press **Home**  >  > **Browser** > **Menu**  > **Bookmarks**.
2. Touch and hold an entry from the list to display an onscreen popup menu.
3. Touch **Add shortcut to home** to add the selected entry to your home screen.

Portable Wi-Fi Hotspot

Portable Wi-Fi Hotspot allows you to turn your phone into a Wi-Fi hotspot. The feature works best when used in conjunction with 4G data services (although 3G service can also be used).



Set Up Portable Wi-Fi Hotspot

1. Press **Home**  >  > **Settings** > **More...** > **Tethering & portable hotspot**.
2. Touch **Portable Wi-Fi hotspot** and place a check mark in the adjacent field to activate the service.
 - Using both 4G service and hotspot drains your phone's battery at a much faster rate than when using any other feature combination.



Note: The best way to keep using the phone as a hotspot is to have it connected to a power supply.

Important: Write down the passkey (password) for this communication (shown onscreen).

Connect to Portable Wi-Fi Hotspot

1. Enable Wi-Fi (wireless) functionality on your target device (laptop, media device, etc.).
2. Scan for Wi-Fi networks from the device and select your phone hotspot from the network list.
 - The name for your phone hotspot can be changed by pressing **Home**  >  > **Portable Wi-Fi hotspot** > **Network SSID**.
3. Select this device and follow your onscreen instructions to enter the passkey (provided on the Portable Wi-Fi hotspot page).
4. Launch your Web browser to confirm you have an Internet connection.



Configure Portable Wi-Fi Hotspot

1. Press **Home**  > **Menu**  > **System settings** > **More...** > **Tethering & portable hotspot** > **Portable Wi-Fi hotspot settings**.
2. Set the following options:
 - **Network SSID:** Sets your network name.
 - **SSID broadcast:** Selects the check box to broadcast the SSID.
 - **Security:** Sets the security level.
 - **Password:** Sets a password if necessary.
 - **Maximum Wi-Fi clients:** Sets the maximum Wi-Fi clients that can connect to your phone.
 - **Auto off:** Sets the length of time to elapse when your hotspot feature is disabled if there is no device connected.
 - **Channel:** Selects the channel you want to use.
 - Press **Menu**  > **Advanced:** Sets the advanced settings, such as local router IP settings or DHCP server settings.

When the portable Wi-Fi hotspot is active and is ready to share its connection, the hotspot icon  appears on the status bar.

Phone As Modem

You can tether your phone to your computer with a USB cable, to share your phone's Internet connection with your computer.

1. Press **Home**  > **Menu**  > **System settings** > **More...** > **Tethering & portable hotspot**.
2. Check the **Phone as Modem** check box to turn on the tethered mode.

When the tethered mode is active, the tethered mode icon  appears on the notification panel.

If you want to use your phone in tethered mode whenever it is connected to a PC, select Phone as modem in Default connection type of PC connection. See [PC Connection Settings](#).

Camera and Video

You can use the camera or video camera to take and share pictures and videos. Your phone comes with a 5.0 megapixel main camera with an autofocus feature that lets you capture sharp pictures and videos.

Take Pictures

The following topics teach you how to take pictures with your phone's camera.

Open or Close the Camera

You can open the camera through the applications list and close it from the camera menu. In addition to using the applications list to open the camera, you may be able to launch the camera from within other applications such as Contacts or Messaging.

Open the Camera

To open the camera in picture mode and take pictures:

- ▶ Press and hold the camera button on the lower right side of the phone.

- or -

Press **Home**  >  > **Camera**.

Tip: You can open the camera from the lock screen. Flick .

Close the Camera

- ▶ On the camera screen, press **Home**  or **Back** .

Camera Viewfinder Screen

The Viewfinder screen lets you view your subject and access camera controls and options.

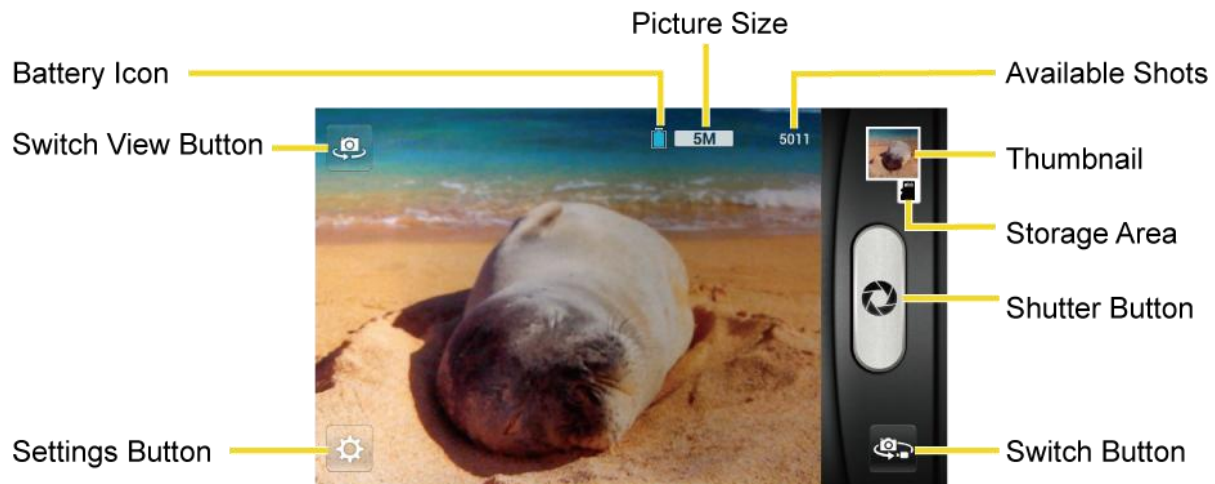

- **Switch View Button:** Switches between the back camera lens and the front-facing camera lens (for self-portraits, video chatting, etc.).
- **Settings Button:** Opens the camera settings menu and lets you change the camera settings. For more information, see [Camera Settings](#).
- **Battery Icon:** Displays how full the battery is.
- **Picture Size:** Displays the current picture size.
- **Available Shots:** Displays remaining shots with the current settings.
- **Thumbnail:** Displays the thumbnail of the latest image. Touch to view and manage.
- **Storage Area:** Displays where the pictures you take will be saved.
- **Shutter Button:** Takes a picture.
- **Switch Button:** Switches between the camera mode and the video camera mode.

Take a Picture

You can take high-resolution pictures using your phone's digital camera.

1. Press and hold the camera button on the lower right side of the phone.

– or –

Press **Home**  >  > **Camera**.

2. Touch  if you want to select the front-facing camera.
3. Change the settings if necessary. See [Camera Settings](#).
4. Before taking the picture, you can zoom in on your subject.

- To zoom in and out, slide the screen with your finger up and down. The zoom slider appears on the screen.

5. Frame your subject on the screen.

Tip: Hold the phone vertically when taking portrait shots or hold the phone horizontally when taking landscape shots.

6. Touch  to take the picture.

7. Choose what you want to do with the picture you've just taken. See [Review Screen](#) for details.

Review Screen

After capturing a picture or video, touch the thumbnail image to see the item in the review screen. From there, you can instantly share your photos or videos, (see [Share Pictures and Videos](#)) or touch the Gallery icon to edit your photos or videos (see [View Pictures and Videos](#)).

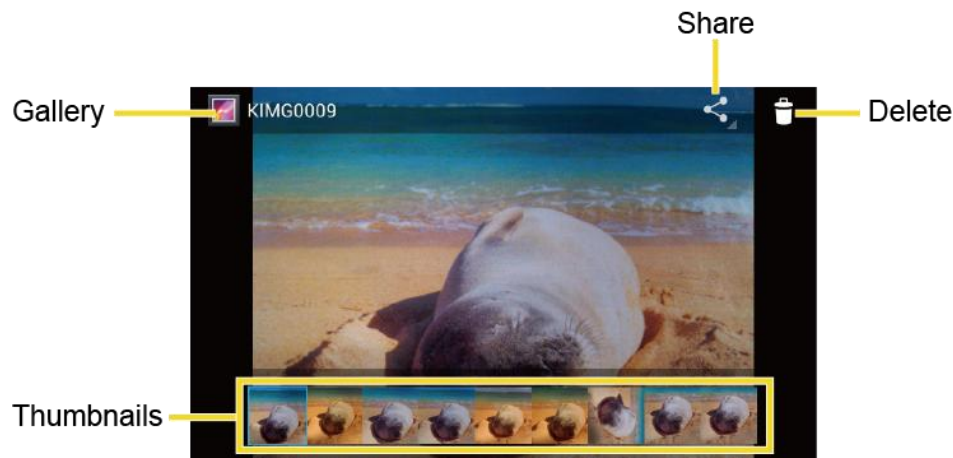

- **Gallery:** Opens the Gallery application. See [View Pictures and Videos Using Gallery](#).
- **Thumbnails:** Displays the pictures in the same album as the currently displayed image. Touch a thumbnail to expand it.
- **Share:** Displays the available applications to share your image.
- **Delete:** Delete the currently displayed image. Confirm the deletion by touching **Delete** again.

Record Videos

The following topics teach you how to record videos with your phone's video camera.

Video Viewfinder Screen

The viewfinder screen lets you view your subject and access video camera controls and options.

You'll find the following controls on the video viewfinder screen:

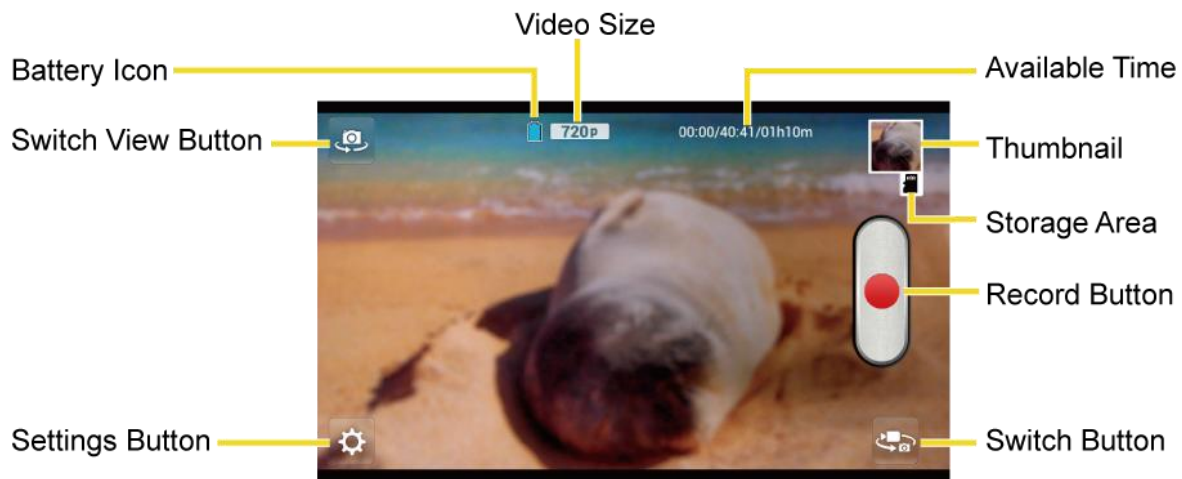

- **Switch View Button:** Switches between the back camera lens and the front-facing camera lens (for self-portraits, video chatting, etc.).
- **Settings Button:** Displays the video settings menu. For more information, see [Video Camera Settings](#).
- **Battery Icon:** Displays how full the battery is.
- **Video Size:** Displays the current video size.
- **Available Time:** From the left, displays the current recording time, the remaining recording time with the current settings, and the total recording time.
- **Thumbnail:** Displays the thumbnail of the latest image. Touch to view and manage.
- **Storage Area:** Displays where the videos you take will be saved.
- **Record Button:** Records a video. Touch again to stop.
- **Switch Button:** Switches between the camera mode and the video camera mode.



Record Videos



Record high-quality videos using your phone's video camera.

1. Press and hold the camera button at the lower right side of the phone.

– or –

Press **Home**  >  > Camera.

2. Touch  to activate video camera mode.
3. Touch  if you want to select the front-facing video camera.

4. Change the settings if necessary. See [Video Camera Settings](#).
5. Holding the phone in landscape mode, frame your subject on the screen.
6. Touch  to start capturing video.
7. Touch  to stop recording.
8. Choose what you want to do with the video you've just captured. See [Review Screen](#) for details.



Camera Settings





You can adjust your camera's settings using the icons on the main camera screen and the full camera settings menu.

1. Press and hold the camera button at the lower right side of the phone.

– or –

Press **Home**  >  > **Camera**.

2. Touch  if you want to select the front-facing camera.
3. Touch  for the available options (some options are available to the back-facing camera only or the front-facing camera only):
 -  **Picture mode:** Select from **Normal**, **Continuous shooting**, **Panorama**, **Smile shutter**, **Effects**, or **HDR**.
 - **Normal:** Takes a normal picture.
 - **Continuous shooting:** Takes up to nine pictures continuously while pressing the shutter button.
 - **Panorama:** Takes a panorama picture as you pan the phone sideways.
 - **Smile shutter:** Detects a smile on a face and automatically takes a picture without your touching the shutter button.
 - **Effects:** Takes a picture with various types of effects, such as **Colored pencil**, **Poster**, **Kaleidoscope**, **Fish-eye**, and more.
 - **HDR:** Takes three pictures at different exposure levels and combines them into one picture. It compensates the loss of detail at each exposure level and helps produce a clear and detailed picture. The shutter sounds only once while taking the three pictures.

-  **Size:** Selects from **5.0M(2592x1944)**, **3.2M(2048x1536)**, **2.0M(1600x1200)**, **1.3M(1280x960)**, **0.8M(1024x768)**, **WVGA(800x480)**, or **VGA(640x480)**.
-  **Zoom:** Displays the zoom slider on the screen. Drag the slider to zoom in and out.
-  **Camera light:** Selects from **ON**, **OFF**, or **Auto**.
-  **More Settings:**
 - **Focus settings:** Selects from **Auto**, **Face detection**, **Macro**, or **OFF**.
 - **Shooting scene:** Selects from **Auto**, **Portrait**, **Scenery**, **Night portrait**, **Night scenery**, or **Action**.
 - **Add location info:** Touch the OFF icon to turn it on. Touch the ON icon to turn it off.
 - **Image quality:** Selects from **Super fine**, **Fine**, or **Normal**.
 - **Blink detection:** Touch the OFF icon to turn it on. Touch the ON icon to turn it off.
 - **Auto exposure:** Selects from **Frame average**, **Center weighted**, or **Spot metering**.
 - **Select ISO:** Selects from **Auto**, **100**, **200**, **400**, or **800**.
 - **White balance:** Selects from **Auto**, **Daylight**, **Cloudy**, **Incandescent**, or **Fluorescent**.
 - **Auxiliary line:** Selects from **OFF** or **Grid**.
 - **Auto-review:** Selects from **Moment auto-review**, **Auto-review**, or **OFF**.
 - **Default settings:** Resets all the camera settings to the factory default settings. Touch **OK** to confirm.

Note: If you select items other than **Auto** for **Shooting scene**, you cannot select **Flash mode**, **Focus settings**, **Auto exposure**, **Select ISO**, and **White balance**.









Video Camera Settings

You can adjust your video camera settings using the icons on the main video camera screen and the full video camera settings menu.

1. Press and hold the camera button at the lower right side of the phone.

– or –

Touch **Home**  >  > **Camera**.

2. Touch  to activate video camera mode.
3. Touch  if you want to select the front-facing video camera.
4. Touch  for the available options (some options are available to the back-facing camera only):
 -  **Video mode:** Selects from **Normal** or **Effects**.
 -  **Size:** Selects from **HD(1080p)**, **HD(720p)**, **WVGA**, **VGA**, **QVGA**, or **MMS(30s)**.
 -  **Zoom:** Displays the zoom slider on the screen. Drag the slider to zoom in and out.
 -  **Camera light:** Selects from **ON** or **OFF**.
 -  **More Settings:**
 - **Auto exposure:** Selects from **Frame average**, **Center weighted**, or **Spot metering**.
 - **White balance:** Selects from **Auto**, **Daylight**, **Cloudy**, **Incandescent**, or **Fluorescent**.
 - **Auxiliary line:** Selects from **OFF** or **Grid**.
 - **Time lapse interval:** Selects from: **1s**, **1.5s**, **2s**, **2.5s**, **3s**, **5s**, **10s**, or **OFF**.
 - **Default settings:** Resets all the video camera settings to the factory default settings. Touch **OK** to confirm.

View Pictures and Videos Using Gallery

Using the Gallery application, you can view pictures and watch videos that you've taken with your phone's camera, downloaded, or copied onto your microSD card or phone memory.

For pictures that are on your microSD card or phone memory, you can do basic editing such as rotating and cropping. You can also easily assign a picture as your contact picture or wallpaper and share pictures with your friends.

Open or Close Gallery

The Gallery app opens in the Albums view where your pictures and videos are organized by albums for easy viewing.

Open the Gallery App

- ▶ Press **Home**  >  > **Gallery**.

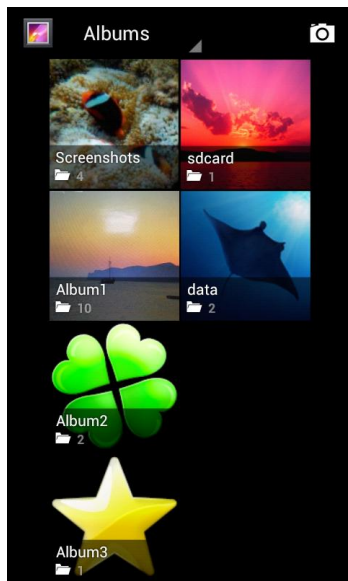

Photos or videos you took with the internal camera are stored in **Camera** album.

Folders in your storage card or phone memory that contain pictures and videos will also be treated as albums. The actual folder names will be used as the album names. If you have downloaded any pictures and videos, these will be placed in the **Download** album.

When viewing pictures in Gallery, scroll left or right the screen to view more albums. Simply touch an album to view the pictures or videos in that album.



Note: Depending on the number of pictures stored, it may take some time for Gallery to load all your albums on the screen.

Close the Gallery App

- ▶ While in the Gallery screen, press **Home** .

View Pictures and Videos.

After selecting an album, you can browse through the pictures and videos of that album in grid view. Touch a picture or video to view.

1. Press **Home**  >  > **Gallery** and touch an album (such as Camera).



2. Touch an image to view the picture.

Note: Press **Menu**  to select images or sort images.





Zoom In or Out on a Picture

There are two ways you can zoom in or out of a picture.

- ▶ Touch the screen twice quickly to zoom in, and then touch the screen twice quickly again to zoom out.
- or –
- Pinch the screen using your thumb and forefinger to zoom out or spread the screen to zoom in.

Watch Video

Use the onscreen controls to play, pause, or stop the video.

1. Press **Home**  >  > **Gallery**.
2. Touch an album containing a video you want to watch, and then touch an image to view the video.
 - Touch  to play the video.
 - Touch  to pause the video.

- Drag the dot on the timeline to rewind or forward the video.

Working with Pictures

You can manage your pictures and videos.



Picture Options Menu

With a picture displayed, press **Menu**  to show the following menu.

- **Delete:** Deletes the selected picture/video.
- **Slideshow:** Starts the slideshow of the pictures stored.
- **Edit:** Edits the picture. See [Edit a Picture](#).
- **Rotate left/Rotate right:** Rotates the picture.
- **Crop:** Crops the picture. See [Crop a Picture](#).
- **Details:** Shows the details of the picture.
- **Set picture as:** Sets the picture as the contact photo or wallpaper.
- **Show on map:** Shows the location where you took the picture in Google Maps if Store location is set to ON. See [Camera Settings](#).





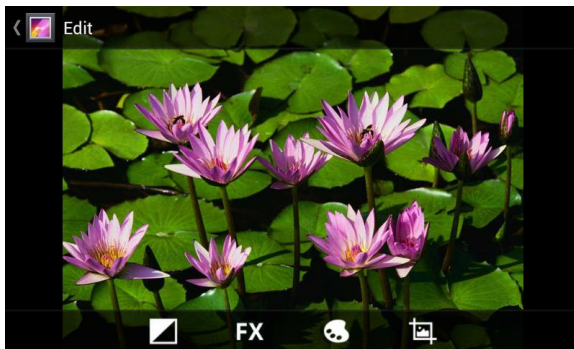

Edit a Picture

Your phone has a built in editing tool and you can alter the picture you took easily.

1. Press **Home**  >  > **Gallery**.
2. Touch an album and then touch a picture.
3. Press **Menu**  > **Edit**.





4. Touch the following icon to edit the picture and scroll left and right to select your favorite effect.



-  to add exposure effect.
-  to add artistic effect.
-  to add color effect.
-  to add additional effect.
-  to undo the action.
-  to redo the action.

5. When finished, touch **SAVE**.

Rotate and Save a Picture

1. Press **Home**  >  > **Gallery**.
2. Touch an album.
3. Touch the picture you want to rotate.
4. Press **Menu**  > **Rotate left** or **Rotate right**.

Crop a Picture

1. Press **Home**  >  > **Gallery**.
2. Touch an album.
3. Touch the picture you want to crop.
4. Press **Menu**  > **Crop**. A crop box appears on the picture.

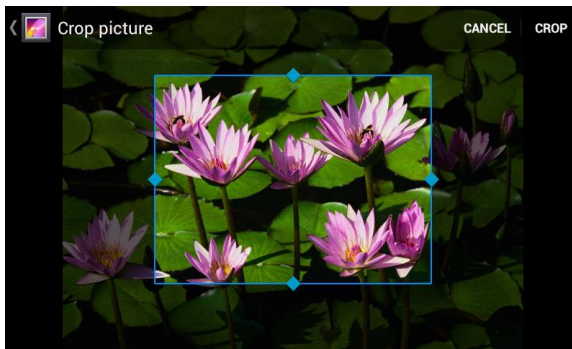

5. To adjust the crop box size, touch and hold the edge of the box. When directional arrows appear, drag your finger inward to or outward to resize the crop box.

6. To move the crop box to the part of the picture that you want to crop, drag the crop box to the desired size and position.
7. Touch **CROP** to apply the changes to the picture.





The cropped picture is saved in the album as a copy. The original picture remains unedited.

Share Pictures and Videos

The Gallery application lets you send pictures and videos using email or multimedia messages. You can share pictures on your social networks such as Picasa and share videos on YouTube. You can also send them to another phone or your computer using Bluetooth.

Send Pictures or Videos by Email/Gmail

You can send several pictures, videos, or both in an email or Gmail message. They are added as file attachments in your email.



1. Press **Home**  >  > **Gallery**.
2. Touch the album that contains the pictures or videos you want to share.
3. Touch and hold the picture or video until you see a blue frame around it. Touch multiple pictures and videos to select them.
4. Touch  > **Gmail** or **Email**. If you cannot find it, touch **See all...**
5. Compose your message and then touch .

Note: If you selected **Mail** and you have multiple email accounts, the default email account will be used.

For more information about using email and Gmail, see [Compose and Send Email](#) or [Send a Gmail Message](#).

Send Pictures or Videos by Multimedia Message

Multimedia Messaging (MMS) lets you send pictures and videos using your phone's messaging app. Although you can send several pictures or videos in a multimedia message, it may be better to just send one at a time, especially if the files are large in size.



1. Press **Home**  >  > **Gallery**.
2. Touch the album that contains the pictures or videos you want to share.
3. Touch and hold the picture or video until you see a blue frame around it. Touch multiple pictures and videos to select them.
4. Touch  > **Messaging**. If you cannot find it, touch **See all...**

5. Compose your message and then touch **Send**  .

For more information about sending multimedia messages, see [Send a Multimedia Message \(MMS\)](#).



Send Pictures or Videos Using Bluetooth

You can select several pictures, videos, or both and send them to another phone or your computer using Bluetooth.

1. Press **Home**  >  > **Gallery**.
2. Touch the album that contains the pictures or videos you want to share.
3. Touch and hold the picture or video until you see a blue frame around it. Touch multiple pictures and videos to select them.
4. Touch  > **Bluetooth**.
5. In the next few screens, you'll be asked to turn on Bluetooth on your phone and connect to the receiving Bluetooth device so the files can be sent. For more information, see [Bluetooth](#).



Share Pictures and Videos on Google+



You need to be signed in to a Google Account to share pictures and videos on Google+.

1. Press **Home**  >  > **Gallery**.
2. Touch the album that contains the pictures or videos you want to share.
3. Touch and hold the picture or video until you see a blue frame around it. Touch multiple pictures and videos to select them.
4. Touch  > **Google+**.
5. Follow the instructions on the screen.

Share Pictures on Picasa



You need to be signed in to a Google Account to upload pictures to the Picasa™ picture organizing service.

1. Press **Home**  >  > **Gallery**.
2. Touch the album that contains the pictures you want to share.
3. Touch and hold the picture until you see a blue frame around it. Touch multiple pictures to select them.

4. Touch  > **Picasa**.
5. Select the online album where you want to upload the pictures, or touch  to create a new album.
6. Touch **Upload**. You can view the pictures online at picasaweb.google.com.

Share Videos on YouTube

You can share your videos by uploading them to YouTube™. Before you do this, you must create a YouTube account and sign in to that account on your phone.

1. Press **Home**  >  > **Gallery**.
2. Touch the album that contains the videos you want to share.
3. Touch and hold the video until you see a blue frame around it. Touch multiple videos to select them.
4. Touch  > **YouTube**.
5. Enter the prompted information, such as description and tags, and select a privacy option.
6. Touch **Upload**.

Tools and Calendar



Learn how to use many of your phone's productivity-enhancing features.

Calendar

Use Calendar to create and manage events, meetings, and appointments. Your Calendar helps organize your time and reminds you of important events. Depending on your synchronization settings, your phone's Calendar stays in sync with your Calendar on the Web, or the corporate calendar.

Add an Event to the Calendar

Add events to your calendar directly from the Calendar application.

1. Press **Home**  >  > **Calendar**.
2. On any Calendar view, press **Menu**  > **New event**.
3. If you have more than two calendars, select a calendar in which to add the event:

Note: You can create multiple Google Calendars only in Google Calendar on the Web. After creating them in Google Calendar on the Web, you'll be able to see them in the Calendar application on your phone. For more information about creating and managing multiple Google Calendars, visit the Google website: calendar.google.com.

Note: If you have synchronized your phone with an Exchange ActiveSync account or Outlook on your computer, you can also select these calendars.

4. Enter a name for the event.
5. Enter the event location.
6. To specify the date and time of the event, do one of the following:
 - If there is a time frame for the event, touch the **FROM** and **TO** dates and times to set them.
 - If the event is a special occasion such as a birthday or an all-day event, set the **FROM** and **TO** dates, and then select the **ALL DAY** check box.
7. Enter email addresses to invite guests to your event and add the event descriptions. See [Invite Guests to Your Calendar Event \(Google Account Only\)](#).
8. If the event occurs on a regular basis, touch the **REPETITION** box and then choose how often the event occurs.

9. Set the event reminder time and select how you are notified.

Note: You can add another reminder time in a Google Calendar event. Touch **Add reminder** to add another reminder.

10. Select your status to be displayed on your calendar.
11. Set the privacy status of this event.
12. Touch **DONE**.

Invite Guests to Your Calendar Event (Google Account Only)

If you want to invite guests to your event, you need to create and add the event in your Google Calendar.

An email invitation will be sent to your guests using your Google Account.

1. Open Calendar and create a new event. Touch the Calendar field and then select your Google Account (or one of your other Google Calendars). See [Add an Event to the Calendar](#).
2. Add details about the event, such as date and time, location, and more.
3. In the **GUESTS** field, enter the email addresses of everyone you want to invite to the event. Separate multiple addresses with commas.
4. Add the description of the event to be displayed on the email to your guests.
5. Touch **DONE** to add the event to your Google Calendar.

If the people to whom you send invitations use Google Calendar, they'll receive an invitation in Calendar and by email.

Calendar Event Alerts

When your phone is turned on and you have an event alarm scheduled, your phone alerts you and displays the event summary. There are several ways your phone alerts you to scheduled events:

- By playing the assigned ringer or vibration type.
- By showing the  icon on the status bar.
- By showing the Alert pop-up screen.

Event Reminders

If you have set at least one reminder for an event, the upcoming event icon  will appear in the notifications area of the status bar to remind you of the upcoming event.

To view, dismiss, or snooze the reminder:

1. Slide the status bar down to open the Notifications panel.
2. Touch the upcoming event name to display the event.

Note: If you have other pending event reminders, these events will also appear on the screen.

3. Do one of the following:
 - Touch **Snooze all** to snooze all event reminders for five minutes.
 - Touch **Dismiss all** to dismiss all event reminders.
 - Press **Back**  to keep the reminders pending in the notifications area of the status bar.

To set reminder settings:

- ▶ On any Calendar view, press **Menu**  > **Settings** > **General settings**, and set the items under **REMINDER SETTINGS**.

View Calendar Events

You can display the Calendar in daily, weekly, monthly, or agenda view. To change the Calendar view, touch the date displayed at the upper left corner, and touch **Day**, **Week**, **Month**, or **Agenda**.

The color of the events indicates the type of calendar that includes the event. To find out what each color represents, press **Menu**  > **Calendars to display**.

Day and Agenda Views

Day view displays a list of the events of one day. Agenda view shows a list of all your events in chronological order.

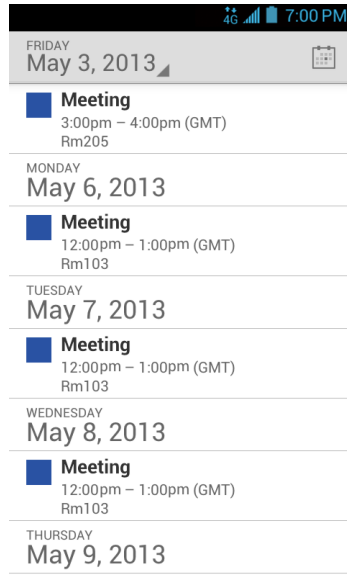
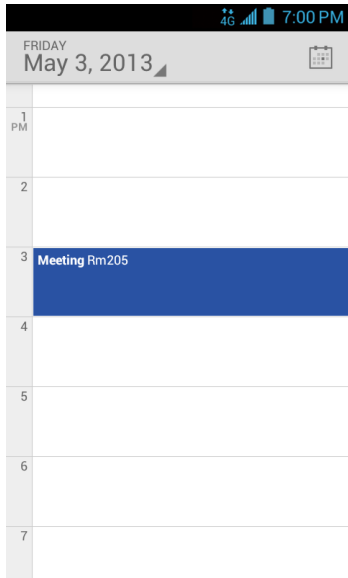

When in Day view, slide left or right across the screen to view earlier or later days.

Week View

Week view displays a chart of the events of one week.

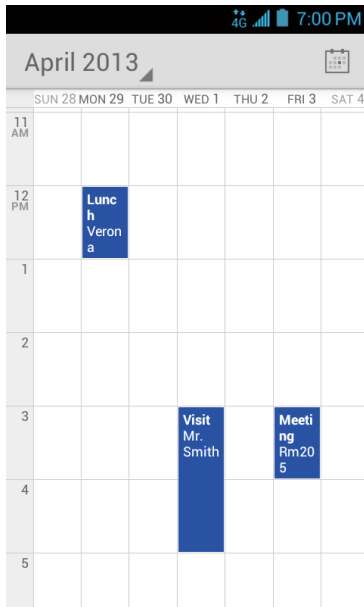

When in Week view:

- You can touch and hold on a time slot to create a new event at that time.
- Touch an event to view its details.
- Slide left or right across the screen to view earlier or later weeks.

Month View

In Month view, you'll see markers on days that have events.





When in Month view:

- Touch  to highlight the current day.
- Touch a day to view the events of that day.
- Slide up or down the screen to view earlier or later months.

Erase Calendar Events

It's easy to erase scheduled events from your calendar.



1. Press **Home**  >  > **Calendar**.
2. Open the calendar event details:
 - In **Agenda**, **Day**, and **Week** views, touch the calendar event you want to delete.
 - In **Month** view, touch the date where the calendar event occurs, and then touch the calendar event.
3. Touch  > **OK**.
4. In the **Delete event** confirmation box, touch **OK**.

– or –

If the calendar event is recurring, select **Only this event**, **This and future events**, or **All events** and touch **OK**.

Show or Hide Calendars





If you have more than two calendars available, you can choose to show or hide a calendar from your current view.

1. Press **Home**  >  > **Calendar**.
2. In any Calendar view, press **Menu**  > **Calendars to display**, and then select or clear a calendar to show or hide it.

Synchronize Calendars with Your Phone

You can choose which Google Calendars to keep synchronized on your phone or which ones to stop synchronizing.

Synchronize a Google Calendar

1. Press **Home**  > **Menu**  > **System settings** > **Accounts & sync**.
2. Touch the account you want to sync with.
3. Touch **Sync Calendar**.
4. Press **Home**  >  > **Calendar**.
5. In any Calendar view, press **Menu**  > **Calendars to display** > **Calendars to sync**.
6. Select the check box next to the Google calendar you wish to synchronize.
7. Touch **OK**.

Synchronize a Corporate Calendar

If you have set up a corporate account on your phone, you can also synchronize corporate calendar events on your phone. Calendar events on your corporate account will also show in Calendar if you chose to synchronize with the Exchange ActiveSync Server.

Clock

The Clock application functions as a desk clock that shows the date and time. You can also use it to turn your phone into an alarm clock.

Open Clock

The instructions below show how to open the Clock app.

- ▶ Press **Home**  >  > **Clock**.

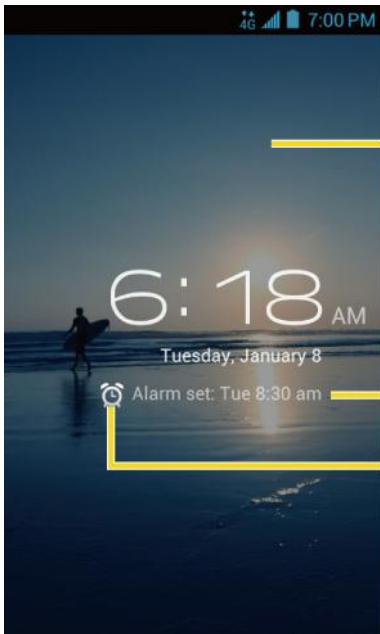

Touch empty space to dim the screen.



The time when the next alarm is set.

Touch the icon to set an alarm.

Alarm

You can use your phone as an alarm clock.

Set an Alarm

1. Press **Home**  >  > **Clock**.
2. Touch  on the screen.

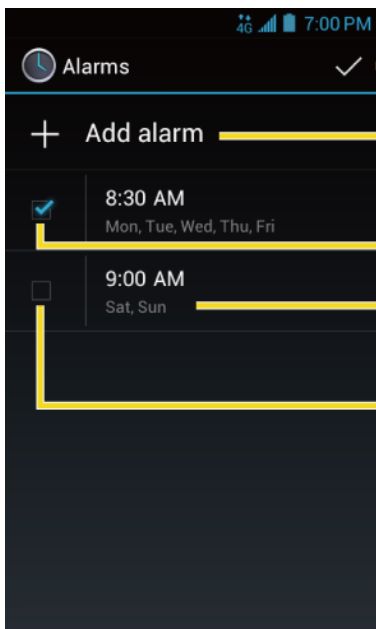

Touch to return to the main Clock screen.

Touch to add an alarm.

Alarm is ON.



Touch to open a screen where you can customize an alarm.

Touch to turn an alarm on or off.

Note: When you first open the alarms, two alarms are set up by default and ready for you to customize. These alarms are turned off by default.





3. Touch an existing alarm to change the settings or touch **Add alarm** to add a new one and set the alarm time.
4. Touch **Time** to adjust the hour and minute by touching ▲ or ▼ or scrolling each value.
5. Touch **Repeat** to select a repeat status for the alarm.
6. Touch **Ringtone** to select a ringtone that will play as an alarm.
7. Touch **Vibrate** to add a vibration feature to the alarm.
8. Touch **Label** to enter a name for the alarm.
9. Touch **Turn alarm on** to set the alarm on.
10. When you're finished, touch **OK**. (Alarms that are set are checked in blue.)
 - Touch the check mark next to an alarm to turn it on or off.

Delete an Alarm

1. Press **Home**  >  > **Clock**.
2. Touch  on the screen.
3. From the Alarms screen, touch a desired alarm, and then touch **Delete**.
4. Touch **OK** to confirm the deletion.

Change Alarm Settings





You can configure the settings of the alarm feature.

1. Press **Home**  >  > **Clock**.
2. Touch  on the screen.
3. From the Alarms screen, press **Menu**  > **Settings**.
4. Configure the following options.
 - **Alarm in silent mode:** Select to sound the alarm even when the phone is set to silent mode.
 - **Alarm volume:** Select to set the alarm volume.

- **Snooze duration:** Select to set the snooze duration from 5 to 30 minutes in 5-minute intervals.
- **Auto-silence:** Select to set how long the alarm sounds.
- **Volume and Camera buttons:** Select to set the behavior of the volume and camera buttons when pressed while the alarm sounds. Choose from: **None**, **Silence**, **Snooze**, or **Dismiss**.
- **Set default ringtone:** Select to set the ringtone for the alarm.

Calculator



Your phone's convenient built-in calculator lets you perform basic mathematical equations.

1. Press **Home**  >  > **Calculator**.
2. Enter numbers by touching the onscreen keys.
3. Touch **DELETE** to clear a number. Touch and hold to clear an entire number.
 - To access more advanced features, flick the screen left or press **Menu**  > **Advanced panel**.
4. Press **Back**  to close the calculator.

LED Flashlight

Your phone's camera flash can work as an LED flashlight.

Warning: Do not shine the LED flashlight into anyone's eyes, as doing so may compromise their vision and cause an accident.

1. Press **Home**  >  > **LED Flashlight**.
2. Touch the screen to switch the light on and off.

– or –

Press the DC button to switch on and off the light while the application is open. No Direct Connect calls can be connected while using the DC button for the LED flashlight.

Voice Services

Your phone's voice services let you place calls using your voice, convert text into speech, and more.

Automatic Speech Recognition (ASR)

You can use your phone's built-in automatic speech recognition (ASR) software (Voice Dialer) to dial a phone number in your contacts or to launch phone functions. All you have to do is to talk into the phone, and ASR will recognize your voice and complete tasks by itself.

Activate the Voice Dialer



- ▶ Press **Home**  >  > **Voice Dialer**.

The phone prompts you to say a command from the list displayed on the screen. To complete your task, simply follow the onscreen prompts or touch an onscreen option.



If the application does not recognize the number, name, or application name, it will find the most likely matches and display a list. Touch a selection or touch **Cancel** to exit the Voice Dialer.

Tip: Use ASR in a quiet environment so it can accurately recognize your commands.



Make a Voice Call with the Voice Dialer

1. Press **Home**  >  > **Voice Dialer**.
2. When prompted to speak, say "**Call** [contact]" or "**Dial** [number]."
 - For example, say "**Call John Smith on mobile**," to call John Smith's mobile phone. Your phone dials the number stored for the contact "John Smith" with the label "Mobile."

Open an Application with the Voice Dialer



1. Press **Home**  >  > **Voice Dialer**.
2. When prompted to speak, say "**Open** [application name]."
 - For example, say "**Open Calendar**," to open the Calendar. The application screen is displayed.

Open a Settings Menu with the Voice Dialer

1. Press **Home**  >  > **Voice Dialer**.
2. When prompted to speak, say "**Open** [settings menu name]."
 - For example, say "**Open sound settings**." The Sound settings menu screen is displayed.

Text-to-Speech Settings

Your phone can convert text into speech in some downloaded applications. You may select the language you hear or adjust its speed.



1. Press **Home**  > **Menu**  > **System settings** > **Language & input**.
2. Touch **Text-to-speech output**.
3. Select your engine. Touch  to configure the settings of the selected engine.
4. Touch **Speech rate** and select a speed.
5. Touch **Listen to an example** to play a short demonstration of the set speech synthesis.

Voice Search

Voice Search allows you to find information on the web as well as items and information on your phone by speaking your search terms.



1. Touch  on the Google Search Bar.

– or –

Press **Home**  >  > **Search** > .
2. Speak clearly into the phone's microphone. If an error occurs, touch **Speak again** or **Try again**.
3. Touch a matching item from the onscreen list.



Voice Search Settings

You can configure the settings of the voice search feature.

1. Press **Home**  > **Menu**  > **System settings** > **Language & input**.
2. Touch **Voice Search**.
 - **Language** to set the language used when entering text by speaking.
 - **SafeSearch** to filter explicit text and images from the search results. Select from Off, Moderate, or Strict.
 - **Block offensive words** to replace recognized offensive words in transcriptions with [#] when entering text by speaking.
 - **Personalized recognition** to improve speech recognition accuracy.
 - **Google Account dashboard** to manage your collected data.

Eco Mode

The Eco Mode allows you to save battery life while using your phone.

1. Press **Home**  >  > **Eco Mode**.
2. Touch an option to enable or disable the Eco Mode:
 - **On**: Enables the Eco Mode.
 - **Auto On**: Enables the Eco Mode when the remaining battery level falls below the set level. Scroll and set the percentage.
 - **Off**: Disables the Eco Mode.
3. Configure the **Eco settings**. Touch the icon of the following items to select:
 - **Sleep** to set the screen timeout to 15 seconds.
 - **Brightness** to decrease the display brightness.
 - **Wallpaper** to select the Eco wallpaper.
 - **Vibrate on touch** to turn off the vibration feedback.
 - **Auto-rotate screen** to disable the Auto-rotate screen feature.

When Eco Mode is on, the Eco Mode icon  appears on the status bar.







Configured settings in the Eco Mode are automatically reflected in the respective Settings menu, and vice versa.

Bluetooth

Bluetooth is a short-range communications technology that allows you to connect wirelessly to a number of Bluetooth devices, such as headsets and hands-free car kits, and Bluetooth-enabled handhelds, computers, printers, and wireless phones. The Bluetooth communication range is usually approximately 30 feet.

Turn Bluetooth On or Off





Use the settings menu to enable or disable your phone's Bluetooth capabilities.

1. Press **Home**  > **Menu**  > **System settings**.
2. Touch the off icon  next to **Bluetooth** to turn Bluetooth on .
– or –
Touch the on icon  to turn Bluetooth off .

Note: Turn off Bluetooth when not in use to conserve battery power, or in places where using a wireless phone is prohibited, such as aboard an aircraft and in hospitals.





The Bluetooth Settings Menu

The Bluetooth settings menu gives you access to information and controls for your phone's Bluetooth feature.

- ▶ Press **Home**  > **Menu**  > **System settings** > **Bluetooth**.
 - Touch your phone name at the top of the list to set your phone visible to other devices. Touch again to set your phone to not visible to other devices. The duration your phone is visible can be changed.
 - Touch **SEARCH FOR DEVICES** to search for other visible in-range Bluetooth devices.
 - Press **Menu**  > **Rename phone** to rename your phone for Bluetooth access.
 - Press **Menu**  > **Visibility timeout** to select the duration your phone is visible to other devices.
 - Press **Menu**  > **Show received files** to view all files you have received via Bluetooth.

Change the Device Name





The device name identifies your phone to other devices.

1. Press **Home**  > **Menu**  > **System settings** > **Bluetooth**.
2. If Bluetooth is not switched on, touch the off icon  to turn Bluetooth on .
3. Press **Menu**  > **Rename phone**.
4. Enter the name for your phone in the dialog box, and then touch **Rename**.

Connect a Bluetooth Headset or Car Kit

You can listen to music over a Bluetooth stereo headset, or have hands-free conversations using a compatible Bluetooth headset or car kit. It's the same procedure to set up stereo audio and hands-free devices.

To listen to music with your headset or car kit, the headset or car kit must support the A2DP Bluetooth profile.

1. Press **Home**  > **Menu**  > **System settings** > **Bluetooth**.
2. If Bluetooth is not switched on, touch the off icon  to turn Bluetooth on .





3. Make sure that the headset is discoverable, so that your phone can find the headset. Refer to the instructions that came with the headset to find out how to set it to discoverable mode.
4. Touch **SEARCH FOR DEVICES**. Your phone will start to scan for Bluetooth devices within range.
5. When you see the name of your headset displayed on the **AVAILABLE DEVICES** list, touch the name. Your phone then automatically tries to pair with the headset.
6. If automatic pairing fails, enter the passcode supplied with your headset.

The pairing and connection status is displayed below the hands-free headset or car kit name in the Bluetooth devices section. When the Bluetooth headset or car kit is connected to your phone, the Bluetooth paired icon  is displayed in the status bar. Depending on the type of headset or car kit you have connected, you can then start using the headset or car kit to listen to music or make and receive phone calls.

Note: Due to different specifications and features of other Bluetooth-compatible devices, display and operations may be different, and functions such as transfer or exchange may not be possible with all Bluetooth-compatible devices.

Reconnect a Headset or Car Kit



When you have paired a headset with your phone, you should be able to reconnect it automatically by turning on Bluetooth on your phone and then turning on the headset. However, sometimes you will need to reconnect manually, for example if you have been using your headset with another Bluetooth device.

1. Press **Home**  > **Menu**  > **System settings** > **Bluetooth**.
2. If Bluetooth is not switched on, touch the off icon  to turn Bluetooth on .
3. Make sure that the headset is discoverable.
4. Touch the headset's name in the **PAIRED DEVICES** list.
5. If prompted to enter a passcode, try 0000 or 1234, or consult the headset or car kit documentation to find the passcode.
6. If you still cannot reconnect to the headset or car kit, follow the instructions in [Disconnect or Unpair from a Bluetooth Device](#), and then follow the instructions in [Connect a Bluetooth Headset or Car Kit](#).

Disconnect or Unpair from a Bluetooth Device



You can manually disconnect or unpair from a Bluetooth device through the Bluetooth settings menu.

Disconnect a Bluetooth Device

1. Press **Home**  > **Menu**  > **System settings** > **Bluetooth**.
2. On the **PAIRED DEVICES** list, touch the device to disconnect.
3. Touch **OK**.

Unpair from a Bluetooth Device

You can make your phone forget its pairing connection with another Bluetooth device. To connect to the other device again, you may need to enter or confirm a passcode again.



1. Press **Home**  > **Menu**  > **System settings** > **Bluetooth**.
2. On the **PAIRED DEVICES** list, touch  next to the device to unpair.
3. Touch **Unpair**.



Send and Receive Information Using Bluetooth

You can use Bluetooth to transfer information between your phone and another Bluetooth-enabled device such as a phone or notebook computer. The first time you transfer information between your phone and another device, you need to enter or confirm a security passcode. After that, your phone and the other device are paired, and you will not need to exchange passcodes to transfer information in the future.

Send Information from Your Phone to Another Device





You can send the following types of information, depending on the device you are sending to:

- Images and videos
 - Contacts
1. Set the receiving device to discoverable mode. You may also need to set it to “Receive Beams” or “Receive Files”. Refer to the device’s documentation for instructions on receiving information over Bluetooth.
 2. On the phone, open the application that contains the information or file you want to send. For example, if you want to send a saved picture, press **Home**  >  > **Gallery**.
 3. Follow the steps for the type of item you want to send:
 - **Picture or video (in Camera):** After capturing a picture or video, touch the thumbnail and then touch  > **Bluetooth**.

- Pictures and videos (in Gallery): On the **Albums** tab, touch an album. Touch the items you want to share and then touch  > **Bluetooth**.
 - Contact: Display a contact and then press **Menu**  > **Share** > **Bluetooth**.
4. If you are prompted to turn on Bluetooth, touch **Turn on**.
 5. Touch the name of the receiving device.
 6. If prompted, accept the connection on the receiving device, and enter the same passcode on both your phone and the other device, or confirm the auto-generated passcode.
 7. On the receiving device, accept the file.

Receive Information from Another Device

Your phone is capable of receiving a wide variety of file types with Bluetooth, including pictures, videos, or contacts.

1. Press **Home**  > **Menu**  > **System settings** > **Bluetooth**.
2. If Bluetooth is not switched on, touch the off icon  to turn Bluetooth on .
3. Touch your phone name to make your phone visible to unpaired devices.
4. On the sending device, send one or more files to your phone. Refer to the device's documentation for instructions on sending information over Bluetooth.
5. If prompted, enter the same passcode on both your phone and the other device, or confirm the auto-generated passcode. A Bluetooth authorization request is displayed on your phone.
6. Touch **Pair**.
7. When your phone receives a file transfer request notification, slide down the notifications panel, touch the notification, and then touch **Accept**.
8. When a file is transferred, a notification is displayed. To open the file immediately, slide down the notifications panel, and then touch the relevant notification.

When you open a received file, what happens next depends on the file type:

- For a vCard contact file, if there are multiple vCard files on your storage card, you can choose to import one, several, or all of those contacts to your contacts list.

Near Field Communication (NFC) Technology



NFC (Near Field Communication) technology is a short-range, wireless technology that lets you quickly and wirelessly exchange information between your phone and other NFC-enabled smartphones, smart accessories, and NFC-enabled access points. You can also use NFC technology to save, view, create, or change smart tags.

Depending on the applications that you have added to your phone, you might be able to use your phone as a transit pass or as an access pass, by tapping the back of your phone against an NFC-enabled access point, subject to applicable terms and conditions from the particular vendor.

To use NFC technology on your phone, your phone must be within approximately 0.78 in. (2 cm) of the NFC-enabled smartphone, smart accessory, NFC-enabled access point, or smart tag that you want to exchange information with. When information is transferred over an NFC connection, your smartphone vibrates.

Turn NFC On or Off







Use the settings menu to enable or disable your phone's NFC capabilities.

1. Press **Home**  > **Menu**  > **System settings** > **More....**
2. Select the **NFC** check box to turn it on.
– or –
Clear the **NFC** check box to turn it off.

Android Beam

With Android Beam you can beam app content such as Browser pages, YouTube videos, and People contacts, to another NFC-capable device by holding the devices close together.

To turn Android Beam on or off:

1. Press **Home**  > **Menu**  > **System settings** > **More....**
2. If NFC is off, select the **NFC** check box to turn it on.
3. Touch **Android Beam**.
4. Touch the off icon  to turn Android Beam on .
– or –
Touch the on icon  to turn Android Beam off .

To share app contents:

1. With Android Beam turned on, display the contents you want to share on your screen.
2. Bring your phone close to another NFC-enabled device, typically back to back aiming the NFC antenna, and then touch your screen. The app determines what gets beamed.



microSD Card

A microSD™ card is an optional accessory that allows you to store images, videos, music, documents, and voice data on your phone.

Note: Your phone also has some internal space for storing picture, music, etc. just like the SD card. See [Primary Storage](#) for more information.

Insert a microSD Card

Remove the battery cover and the battery to insert a compatible microSD card into your phone.

1. Turn your phone off and remove the battery cover. See [Turn Your Phone On and Off](#) and [Insert and Charge the Battery](#).
2. Lift the battery and remove it.

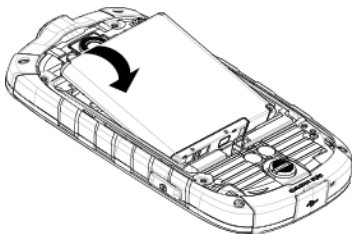

3. Insert a microSD card into the microSD card slot with the gold terminals facing down. Gently push the card in until it snaps into place.

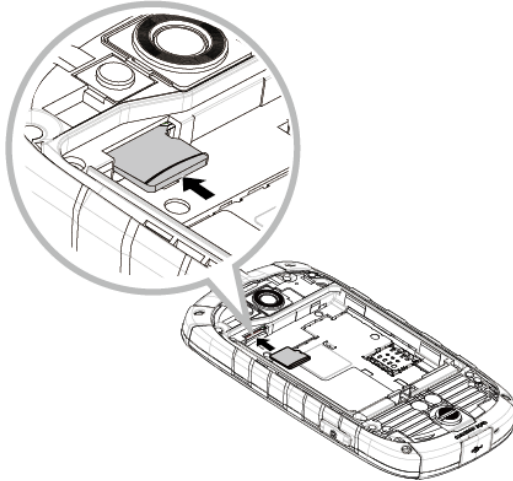

4. Replace the battery and the battery cover. See [Insert and Charge the Battery](#).

Remove the microSD Card

Remove the battery cover and the battery to remove the microSD card from your phone.

1. Turn your phone off and remove the battery cover. See [Turn Your Phone On and Off](#) and [Insert and Charge the Battery](#).
2. Lift the battery and remove it.

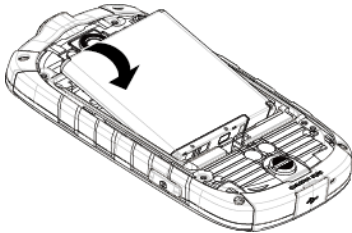

3. Gently push the microSD card inward and release it. The card is now halfway out of the microSD card slot.

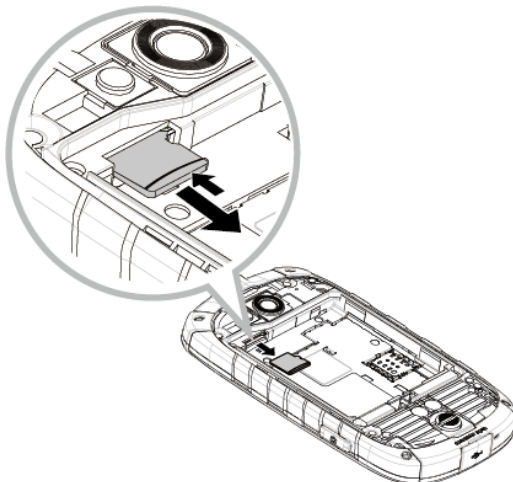



4. Gently pull out the card from the slot.
5. Replace the battery and the battery cover. See [Insert and Charge the Battery](#).

Note: You can easily damage the microSD card by improper operation. Please be careful when inserting, removing, or handling the microSD card.

Note: Make sure your battery is fully charged before using the microSD card. Your data may become damaged or unusable if the battery runs out while using the microSD card.



View the microSD Card Memory

The Storage settings menu gives you access to your microSD card memory information.

- ▶ With the microSD card inserted, press **Home**  > **Menu**  > **System settings** > **Storage**. (The total and available memory space will be displayed.)

Format the microSD Card



Formatting a microSD card permanently removes all files stored on the card.

1. Press **Home**  > **Menu**  > **System settings** > **Storage**.
2. Scroll down the screen, touch **Erase SD card** > **Erase SD card** > **Erase everything**.

Note: The formatting procedure erases all the data on the microSD card, after which the files CANNOT be retrieved. To prevent the loss of important data, please check the contents before you format the card.

Unmount the microSD Card

Unmount the microSD card to prevent corrupting the data stored on it or damaging the microSD card.

1. Press **Home**  > **Menu**  > **System settings** > **Storage**.
2. Touch **Unmount SD card** > **OK**.

Use the Phone's microSD Card as a USB Drive

To transfer music, pictures, and other files from your computer to your phone's microSD card, you need to set the phone's microSD card as a USB drive.

1. Connect the phone to your computer using the supplied USB cable.
2. The **PC connection** screen automatically opens.

– or –

If you see  on the status bar, slide it down to open the Notifications panel and touch the USB connection notification.

3. Touch **Mass Storage** > **Done** > **OK**. See [PC Connection Settings](#).
4. On your computer, the connected phone and the inserted microSD card are recognized as two removable disks. Navigate to these removable disks and open the one containing the data from the microSD card.
5. Do one of the following:
 - Copy files from the computer to the root folder on the phone's storage card.
 - Copy files from the phone's storage card to a folder on your computer or computer desktop.
6. After copying the files, unmount the removable disks (that is, the connected phone) as required by your computer's operating system to safely remove your phone, and disconnect the phone from the computer.

Note: The phone will not recognize the microSD card when it is connected to a computer as a disk drive. You will not be able to use some of the phone's applications such as Camera or Play Music.

Use the Phone's microSD Card as a Media Device

You can connect your phone as a media device to your computer.

1. Connect the phone to your computer using the supplied USB cable.
2. The **PC connection** screen automatically opens.

– or –

If you see  on the status bar, slide it down to open the Notifications panel and touch the USB connection notification.



3. Touch **Media Transfer** > **Done**. See [PC Connection Settings](#).

Update Your Phone

From time to time, updates may become available for your phone. You can download and apply updates through the System update menu.



Update Your PRL

This option allows you to download and update the PRL (preferred roaming list) automatically.

1. Press **Home**  > **Menu**  > **System settings** > **System update** > **Update PRL**.
2. Follow the onscreen instructions.

Update Your Profile

This option allows you to automatically update your online user profile information. If you choose to change your user name and select a new one online, you must then update the user name on your phone.

1. Press **Home**  > **Menu**  > **System settings** > **System update** > **Update profile**.
2. Follow the onscreen instructions.

Note: If your data services or account syncing ever seems to go out unexpectedly, use this feature to reconnect with the network.

Update Your Phone Firmware



This option allows you to update the Android Operating System (OS) and the phone software on your phone via an over-the-air connection.

Before Updating Your Firmware



Updating your phone firmware will erase all user data from your phone. You must back up all critical information before updating your phone firmware.

CAUTION! Make sure to back up all data prior to updating your phone as it will be erased.

To back up your account information:

1. Press **Home**  > **Menu**  > **System settings** > **Accounts & sync**.
2. Touch the account containing the data you want to back up now.
3. Select the check box of the items you want to back up.
4. Press **Menu**  > **Sync now**.



To back up stored text messages:

1. Press **Home**  >  > **Messaging**.
2. Select the text message from the list to view the message thread.
3. Touch and hold on a portion of the text message from the string. The Message options context menu appears.

Note: You can back up stored text messages by forwarding them to your own phone number. Open the messages after you have updated your firmware.



4. Touch **Forward**.

5. Enter your phone number and touch  or  .

As an added precaution, to preserve any data on your microSD card, please unmount it from your phone prior to starting the update process. Press **Home**  > **Menu**  > **System settings** > **Storage** > **Unmount SD card**.

Update Your Phone Firmware

Once you have backed up all your data, use the **Update Firmware** option to update your phone firmware.



1. Press **Home**  > **Menu**  > **System settings** > **System update**.
2. Touch **Update firmware**. (Your phone automatically downloads and installs any available updates. You may be required to power your phone off and back on to complete the software upgrade.)

Confirm Your Current Phone Firmware

1. Press **Home**  > **Menu**  > **System settings** > **About phone**.
2. Locate the version number.



Reinstall Your Google Application

Your Google™ app purchases are reloaded remotely and can be re-installed after the update is applied.

1. Press **Home**  >  > **Play Store**.
2. Press **Menu**  > **My Apps** > **All**.
3. Scroll through the list of previously downloaded Google apps and choose those you wish to reinstall.
4. Follow the onscreen instructions.

Update Kyocera Software

This option provides you the latest Android Operating System (OS) and the phone firmware on your phone via an over-the-air connection.

1. Press **Home**  > **Menu**  > **System settings** > **System update** > **Update Kyocera software**.
2. Follow the onscreen instructions.

Sprint Worldwide Wireless Service

With your phone and global roaming service from Sprint WorldwideSM Wireless Service, you can make phone calls and use wireless data services around the globe on compatible networks. Visit sprint.com/international for details of the coverage.

Activate Sprint Worldwide Service on Your Account

Before using your phone in global roaming mode, you must activate Sprint Worldwide service.

To activate Sprint Worldwide service:

- ▶ Chat with or email an international support rep by visiting sprint.com/international and clicking the **Chat with us** or **Email us** link on the right side of the screen.



– or –

Call Sprint Worldwide Customer support at **1-888-226-7212**.

Enable Global Roaming Mode



Your phone is designed to disable/enable global roaming mode to avoid automatically connecting to an appropriate network when you travel.

To set your global roaming options:

1. Press **Home**  > **Menu**  > **System settings** > **More...** > **Mobile networks** > **Roaming** > **Roaming mode** > **Automatic**.
2. Select the type(s) of communication for which global roaming should be allowed:
 - **International voice** to allow voice communication on international roaming systems.
 - **International data** to allow data communication on international roaming systems.

Note: You cannot select the international data roaming only.

To set your global roaming guards:

1. Press **Home**  > **Menu**  > **System settings** > **More...** > **Mobile networks** > **Roaming** > **Roaming guards**.
2. Select a check box of the category under **INTERNATIONAL** to enable roaming guards for:
 - **Voice** to display a prompt that will require you to respond anytime you attempt to access voice service while roaming internationally.

- **Data** to display a prompt that will require you to respond anytime you attempt to access data service while roaming internationally.
- **Outgoing SMS** to display a prompt that will require you to respond anytime you attempt to send a text message while roaming internationally.

Make and Receive Worldwide Calls





When travelling on international networks, you can place and answer calls as you would on the Sprint network (see [Make Phone Calls](#) and [Receive Phone Calls](#)), although some additional instructions may be required to place a call. Some features and services are not available in all countries. For more information on services that are available while roaming, visit sprint.com/sww.

Make Calls Using Plus (+) Code Dialing





Placing calls from one country to another country is simple with the Plus (+) Code Dialing feature. When placing international calls, you can use Plus Code Dialing to enter the appropriate international access code for your location (for example, 011 for international calls placed from the United States).

Note: International access codes and dialing information are available online at sprint.com/sww.





To use Plus Code Dialing to place an international call from outside the United States or Canada:

1. Press **Home**  >  >  to display the phone screen.
2. Press **Menu**  > **Settings**.
3. Clear the **North American dialing** check box.
4. Touch **International dialing**.
5. Delete the previous value.
6. Enter a new value and touch **OK**.

To use Plus Code Dialing to place an international call from the United States or Canada:

1. Press **Home**  >  >  to display the phone screen.
2. Press **Menu**  > **Settings**.
3. Check the **North American dialing** check box.

To place an international call:

1. Press **Home**  >  >  to display the phone screen.
2. Touch and hold  to insert a “+” on the phone screen. (The “+” symbol automatically inserts the international access code for the country from which you are calling.)
3. Enter the country code and phone number, and then touch . (The phone automatically prepends the access code for international dialing, followed by the country code and phone number.)





Sprint Voicemail Service

Your Sprint voicemail will follow you as you travel. All of your unanswered calls will be forwarded to your Sprint voicemail. You will need to be sure your voicemail box is already set up and that you know your voicemail password.

Note: In India, Sprint voicemail is not available while roaming on the GSM network; it does work while on the CDMA network.

Set Up Your Voicemail Access Number

To simplify accessing your Sprint Voicemail while travelling, you can set up your voicemail access number as a Contacts entry. This will make it faster and easier to access your messages while roaming internationally.

1. Press **Home**  >  > **People** > .
2. Touch  to add a contact.
3. Type the contact information (for example, “Voicemail”).
4. Enter “+”, “1”, your area code, and your wireless phone number.
5. Touch **DONE**.

Access Your Voicemail

You will need to call your voicemail number to access your voicemail while roaming internationally.





New Message Indicators

Your voicemail message indicators may be displayed differently when roaming internationally, or you may not receive notification of new voicemail messages. Sprint recommends that you periodically check your voicemail.

Retrieve Voicemail Messages

The voicemail retrieval process while travelling is the same as on the Sprint Network; however, you will be required to enter your voicemail password.

To retrieve your voicemail messages:

1. Press **Home**  >  > **People** > , touch the voicemail entry and then touch the number to call it.
2. When your voicemail answers, touch , enter the password, and touch  to access your voicemail.

Voicemail Troubleshooting

There are a few tips to keep in mind when using Sprint voicemail while traveling.

- Some carriers may not support voicemail indicators. It may be necessary to call your voicemail to see if you have any new messages.
- If you hear the message “Please enter the number of the subscriber you wish to call,” enter your 10-digit wireless phone number.

International Data Roaming

Sprint Worldwide Wireless Service can also keep you connected via email and Web browsing when travelling in countries in which Sprint offers data service. Data services are available on some networks. Visit sprint.com/sww to determine the services available where you are traveling.

Get Started With Data Services

To use Sprint Worldwide Data Services, you will need to have these services activated on your account.

- ▶ To activate, call Sprint Worldwide Customer Support at **1-888-226-7212**. Representatives are available 24 hours a day, 7 days a week to assist you.

Status Messages

You may receive status messages under certain conditions. Before contacting Sprint Worldwide Customer Support, note the message, numeric code, and the conditions under which it appeared. The following table lists and describes the status messages.

Status Messages	Message Description
Number Not in Service	The number that you entered is not valid.
User Not Available	The phone that you called is either busy, out-of-range, or turned off. Please try again later.
User Not Authorized	The phone that you called is either busy, out-of-range, or turned off. Please try again later.
Please Try Later	This service is temporarily not available. Please try again later.
Service Restricted	Service may not be activated properly. Please contact Sprint Customer Service to report the issue for resolution.

Status Messages	Message Description
Service Not Available	This feature is not available on the current network.
Emergency Calls Only	Either the service is not activated properly or the current network is available for emergency calling only. Adjust your network settings to check for other available networks. If service is still not available after adjusting the settings, contact Sprint Customer Service to report the issue for resolution.
System Busy. Try Later	The system is experiencing heavy traffic. Please try again later.
Service Conflict	This service cannot be enabled because an incompatible service has already been turned on.
Please Try Again	An error occurred. Note the error code and try again.
Self Check Error	A fault was detected with your phone. If this error recurs, note the error and contact Sprint Customer Service.
Self Check Fail	An operational fault was detected with your phone. Note the numeric code, turn your phone off, and contact Sprint Customer Service.
Wrong PIN	You have entered an incorrect SIM PIN number. You have only three attempts to enter your PIN. After a third unsuccessful attempt, your phone will be locked and you will have to call Sprint Customer Service to have it unlocked. Sprint sets the default to PIN off; if you elect to enable the PIN then you will need to contact Sprint for the default PIN and PUK.
PIN Blocked. Call Your Provider	An incorrect SIM PIN was entered three consecutive times. You will be unable to send or receive calls on your phone. Contact Sprint Customer Service to obtain the PIN Unblocked Key (PUK) code. Sprint sets the default to PIN off; if you elect to enable the PIN then you will need to contact Sprint for the default PIN and PUK.
Insert SIM	Your SIM Card is not being detected. Please check to ensure that you have inserted the SIM Card.
Check SIM Card	Please check your SIM card to make sure it is properly inserted.

Contact Sprint for Assistance

If you experience any issues with voice or data services while outside of the United States, Sprint offers customer support 24 hours a day. In the event that you do experience an issue, try the following actions:

- First try powering your phone off and then back on; this will force your phone to reregister with the network.
- Try manually selecting another network. Information for selecting networks can be found in the phone guide.

If neither of these actions resolves your issue, you will need to contact customer service (see below). When calling to report an issue, the following information will be beneficial in trying to resolve your issue as quickly as possible:

- Your wireless phone number.
- The city and country you are travelling in.
- Any error message that displays on your phone or that you heard when trying to place a call.
- If the issue is with data, were you able to place voice calls?
- If the issue is with voice service, were you able to access data?

Please call the numbers below if you need assistance:

While in the United States: Call **1-888-226-7212**.

While traveling outside the United States:

- Enter the country code and then dial **1-817-698-4199**.

There is no charge for this call from your wireless phone.

From a landline phone when outside the United States:

Sprint Worldwide Customer Support can be reached from a landline phone at **1-817-698-4199**. Access or connection fees may apply. The toll free numbers below can also be used to contact Sprint Worldwide Customer Support in the following countries:

Country	From Landline Phone
Caribbean (Anguilla, Barbados, Cayman Islands, and Dominica)	1-888-226-7212
France	0800-903200
Germany	0800-180-0951
Italy	800-787-986
Mexico	001-877-294-9003
Trinidad and Tobago	1-800-201-7545
United Kingdom	0808-234-6616

Note: This toll free service is available on ordinary landline phones and some public pay phones. This service does not cover any hotel access charges.

Settings

The following topics provide an overview of items you can change using your phone's Settings menus.

Wi-Fi Settings

The Wi-Fi settings menu lets you turn Wi-Fi on or off, set up and connect to available Wi-Fi networks, and configure advanced Wi-Fi options.



For more information about Wi-Fi settings, see [Wi-Fi](#).

Access the Wi-Fi Settings Menu

- ▶ Press **Home**  > **Menu**  > **System settings** > **Wi-Fi**.

Advanced Wi-Fi Settings

The advanced Wi-Fi settings menu lets you set up and manage wireless access points.

1. Press **Home**  > **Menu**  > **System settings** > **Wi-Fi**.
2. Press **Menu**  > **Advanced**.
3. Configure your Wi-Fi settings, which may include:
 - **Network notification:** Notifies you when an open Wi-Fi network is available.
 - **Secure network notification:** Notifies you when a secure Wi-Fi network is available.
 - **Wi-Fi auto on:** Enables Wi-Fi automatically.
 - **Wi-Fi auto on schedule:** Enables Wi-Fi for the scheduled period.
 - **Keep Wi-Fi on during sleep:** Stays connected to Wi-Fi when the screen goes to sleep to conserve mobile data usage.
 - **MAC address:** Displays the Media Access Control (MAC) address of your phone when connected to a Wi-Fi network.
 - **IP address:** Displays the Internet Protocol (IP) address assigned to your phone by the Wi-Fi network you are connected to (unless you used the IP settings to assign it a static IP address).

Bluetooth Settings





Your phone's Bluetooth capabilities let you use wireless headsets, send and receive pictures and files, and more. For details on your phone's Bluetooth settings, see [The Bluetooth Settings Menu](#).

Access the Bluetooth Settings Menu

- ▶ Press **Home**  > **Menu**  > **System settings** > **Bluetooth**.

MaxiMZR Settings

MaxiMZR will limit the background data connection based on your personal usage of applications. It will ultimately help conserve battery power with minimal impact to the usability of your phone.





1. Press **Home**  > **Menu**  > **System settings** > **MaxiMZR**.
2. Touch the off icon  to enable MaxiMZR. The on icon  will be displayed.
3. Touch **Apps** to see the list of regulated applications.

Data Usage Settings





The Data usage menu lets you view your phone's mobile and Wi-Fi data usage, set data limits, restrict hotspot usage, and more.

Enable Data Statistics

Enabling the Data statistics feature allows your phone to collect the necessary data.

1. Press **Home**  > **Menu**  > **System settings** > **Data usage**.
2. Touch **Data statistics** if the off icon  is displayed next to it.
3. Read the message and touch **OK**. The on icon  will be displayed next to **Data statistics**.

View Data Usage by Application



1. Press **Home**  > **Menu**  > **System settings** > **Data usage**.
2. Confirm **Mobile data** is set to .
3. Touch  next to **Data usage cycle** to change the period of time for which the chart will display the data usage.

4. Touch either of the white lines on the chart to display the tabs. Drag the white tabs horizontally to see the data usage of a specific period within the displayed cycle.
 - The usage amount will be displayed just below the chart.

Set Data Usage Limit

You can also set the limit for mobile data in case you don't have an unlimited data plan which cuts off data at a specified threshold.

Warning: The usage displayed is measured by your phone. Your carrier's data usage accounting may differ and the usage in excess of your data limit plan can result in charges. Data usage limit set in this menu is not guaranteed to prevent additional charges.

1. Press **Home**  > **Menu**  > **System settings** > **Data usage**.
2. Select the **Set mobile data limit** check box. Read the message and touch **OK**.

Note: Disabling the **Set mobile data limit** feature automatically disables MaxiMZR.

3. Drag the red tab vertically to set the limit you want.

– or –

Touch the red line, select the limit by flicking the value vertically and then touch **Set**.

- When your data usage reaches the limit, mobile data will be turned off automatically.

4. Drag the orange tab vertically to set the level you receive a warning



– or –

Touch the orange line, select the limit by flicking the value vertically and then touch **Set**.

- When your data usage reaches the level set with the orange line, you will see the message.

Restrict Data Usage by Application

You can restrict the background data usage.

1. Press **Home**  > **Menu**  > **System settings** > **Data usage**.
2. Press **Menu**  > **Restrict background data** to check it.
3. Read the message and touch **OK**.

Tip: You can see the Wi-Fi usage. Press **Menu**  > **Show Wi-Fi usage** to check it.

More Settings

The More settings menu provides access to additional wireless and network options, such as mobile networks, VPN, roaming, NFC, and more.



Airplane Mode

Airplane Mode allows you to use many of your phone's features, such as Gallery, Camera, and Music, when you are on an airplane or in any other area where making or receiving calls or data is prohibited. When you set your phone to Airplane Mode, it cannot send or receive any calls or access online information.

To quickly turn Airplane Mode on or off:

- ▶ Press and hold the power button, and then touch **Airplane mode** in the Device options menu. While in Airplane Mode, the status bar will display .

To turn Airplane Mode on or off in Settings:

1. Press **Home**  > **Menu**  > **System settings** > **More....**
2. Select the **Airplane mode** check box. While in Airplane Mode, the status bar will display .

VPN Settings

A virtual private network (VPN) is a network that uses a public telecommunication infrastructure, such as the Internet, to provide remote offices or individual users with secure access to their organization's network. For more information about VPN settings, see [Virtual Private Networks \(VPN\)](#).

Tethering & Portable Hotspot Settings

Use the settings menu to configure your Portable Wi-Fi Hotspot settings, which allow you to share your phone's data service with multiple Wi-Fi capable devices. For details on your phone's tethering and portable hotspot settings, see [Portable Wi-Fi Hotspot](#).



NFC Settings

The NFC (Near Field Communication) settings menu lets you turn NFC on or off. For more information about NFC settings, see [Near Field Communication \(NFC\) Technology](#).



Wi-Fi Direct Settings

Wi-Fi Direct allows Wi-Fi devices to connect to each other without the need for a wireless access point. The Wi-Fi client and the hotspot operation will be disabled while Wi-Fi direct is enabled.

To turn Wi-Fi direct on:

1. Press **Home**  > **Menu**  > **System settings** > **More...** > **Wi-Fi direct**.
2. Read the message and touch **OK**.



To configure Wi-Fi direct settings:

- ▶ Press **Home**  > **Menu**  > **System settings** > **More...** > **Wifi direct settings**. A list of available devices will be displayed.
 - Touch a device to connect to it.
 - Touch **SEARCH** to scan for available devices.
 - Touch **CREATE GROUP** to create a group with an available device.
 - Touch **REMOVE GROUP** to remove a device from a created group.

Mobile Networks Settings

The Mobile networks options let you enable your phone's mobile data access, set your preferred network mode, configure Sprint Connections Optimizer, and select network operators for international use.

Enable Data

1. Press **Home**  > **Menu**  > **System settings** > **More...** > **Mobile networks**.
2. Check the **Data enabled** check box.

Connections Optimizer

Your phone can be set to automatically select the best mobile network. For the details on Connections Optimizer, see [Sprint Connections Optimizer](#).

Roaming Settings

Roaming is the ability to make or receive calls and access data services when you're off the Nationwide Sprint Network.

Roaming Icon

Your display screen always lets you know when you're off the Nationwide Sprint Network. Anytime you are roaming, the phone displays the roaming icon ().

Roaming on Other Networks

When you're roaming on other networks, your call quality and security will be similar to the quality you receive when making calls on the Nationwide Sprint Network. However, you may not be able to access certain features, such as data services, depending on the available network.

Note: If you're on a call when you leave the Nationwide Sprint Network, your call is dropped. If your call is dropped in an area where you think Sprint service is available, turn your phone off and on again to reconnect to the network.

Check for Voicemail Messages While Roaming

When you are roaming off the Nationwide Sprint Network, you may not receive on-phone notification of new voicemail messages. Callers can still leave messages, but you will need to periodically check your voicemail for new messages if you are in a roaming service area for an extended period of time.



1. Dial your area code + your phone number.
2. When you hear your voicemail greeting, touch .
3. Enter your password at the prompt and follow the voice prompts.

When you return to the Nationwide Sprint Network, voicemail notification will resume as normal.



Roaming Settings

Your phone allows you to control your roaming capabilities. By using the Roaming menu option, you can determine which signals your phone accepts. Choose from different settings on your phone to control your roaming experience.

To set the roaming mode:

1. Press **Home**  > **Menu**  > **System settings**.
2. Touch **More...** > **Mobile networks** > **Roaming** > **Roaming mode**.
3. Select an option:
 - **Home only** to access only the Nationwide Sprint Network and prevent roaming on other networks for both voice and data communications.
 - **Automatic** to seek service on the Nationwide Sprint Network. When Sprint service is unavailable, the phone searches for an alternate service. If you select this option, select the type(s) of communication for which roaming should be allowed.

When the roaming mode is set to **Automatic**, you can specify which services are available while roaming.



1. Press **Home**  > **Menu**  > **System settings**.
2. Touch **More...** > **Mobile networks** > **Roaming**.
3. Select an option:

- **Domestic voice** to allow voice communication only on domestic roaming systems.
 - **Domestic data** to allow data communication only on domestic roaming systems.
 - **International voice** to allow voice communication on international roaming systems.
 - **International data** to allow data communication on international roaming systems.
4. If required, touch **Yes**.

Note: Data service is not available without voice service for both domestic and international settings. Disabling voice service automatically disables its data service.



Roaming Guard

Your phone alerts you when you are roaming off the Nationwide Sprint Network by requiring an extra step before you can place or answer a call, or try to access data while roaming.

1. Press **Home**  > **Menu**  > **System settings**.
2. Touch **More...** > **Mobile networks** > **Roaming** > **Roaming guards**.
3. Select each service you want to enable Roaming guards for:
 - **Voice** to display a prompt that will require you to respond anytime you attempt to access voice service while roaming in the selected region (**DOMESTIC** or **INTERNATIONAL**).
 - **Data** to display a prompt that will require you to respond anytime you attempt to access data service while roaming in the selected region (**DOMESTIC** or **INTERNATIONAL**). The prompt will not appear again while you are in the data session you allowed.
 - **Outgoing SMS** to display a prompt that will require you to respond anytime you attempt to send a text message while roaming internationally.

Tip: If you prefer not to use the Roaming guards feature, touch the **Never ask** check box and then touch **OK** or **Roam** while the alert dialog is displayed. You will not be notified of your roaming status until you enable Roaming guards again.

To place roaming calls with Roaming guards on:

1. Press **Home**  > .
2. Touch the area code + the seven-digit number and touch .
3. Read the message and touch **OK**.

To answer roaming calls with Roaming guards on:

- ▶ Read the message and touch **OK**.

To access data services while roaming with Roaming guards on:

- ▶ Read the message and touch **Roam**.

To send a text message while roaming with Roaming guards on:

- ▶ Read the message and touch **Send now**. Touch **Save as draft** to save the message as draft and send it later.

Direct Connect Settings



The Direct Connect settings menu appears when you subscribe to Sprint Direct Connect services. See [Direct Connect Settings](#) for details.

Sound Settings

The Sound settings menu lets you control your phone's audio, from ringtones and alerts to touch tones and notifications.

Volumes



Configure your phone's volume settings.

1. Press **Home**  > **Menu**  > **System settings** > **Sound**.
2. Touch **Volumes** and use the sliders to set the volume level for **Music, video, games, & other media, Ringtone & notifications, Alarms, and DC calls & Call alerts & Invites**.
3. Touch **OK** to save your settings.

Tip: You can adjust the ringer volume in standby mode (or the earpiece volume during a call) by using the volume button on the left side of your phone.

Silent Mode



Configure your phone's silent mode sound settings.

1. Press **Home**  > **Menu**  > **System settings** > **Sound**.
2. Touch **Silent mode** and select a setting:
 - **Off** to turn silent mode off (all sounds are active).
 - **Vibrate** to turn off all sounds but keep vibrate settings for notifications.
 - **Mute** to turn all sounds and vibration off.

Tip: Press the volume button down in standby mode until you see **Vibrate**  or **Mute**  on the screen.



DC Calls Sound

Assign a ringtone to DC calls and Chirp.

1. Press **Home**  > **Menu**  > **System settings** > **Sound** > **DC calls**.
2. Select **Incoming DC calls** or **Chirp**.
3. Select an option from the available list and touch **OK**.



Call Alerts Sound

Select the duration and frequency of the Call Alerts.

1. Press **Home**  > **Menu**  > **System settings** > **Sound** > **Call alerts** > **Repetition**.
2. Configure the following options:
 - **Repeat:** Set the duration of the Call Alerts.
 - **Alert every:** Set the frequency of the Call Alerts.



Phone Ringtone

Assign a ringtone to your incoming calls.

1. Press **Home**  > **Menu**  > **System settings** > **Sound** > **Phone ringtone**.
2. Touch a ringtone from the available list. The ringtone briefly plays when selected.
3. Touch **OK** to assign the ringtone.



Vibrate Pattern

Select a vibration pattern.

1. Press **Home**  > **Menu**  > **System settings** > **Sound** > **Vibrate pattern**.
2. Touch a vibrate pattern from the available list. Your phone briefly vibrates when selected.
3. Touch **OK** to assign the vibrate pattern.

Default Notification



Select a default sound for notifications.

1. Press **Home**  > **Menu**  > **System settings** > **Sound** > **Default notification**.
2. Touch a notification sound from the available list. The sound briefly plays when selected.

3. Touch **OK** to assign the sound.



Vibrate and Ring

Set your phone to ring and vibrate simultaneously.

1. Press **Home**  > **Menu**  > **System settings** > **Sound**.
2. Select the **Vibrate and ring** check box.

Persistent Alerts

Set alerts, such as beep, vibration, or LED blinking for notifications.

1. Press **Home**  > **Menu**  > **System settings** > **Sound** > **Persistent alerts**.
2. Check the following:
 - **Audible tone** to beep when notification is on the notification bar.
 - **Vibrate** to vibrate when notification is on the notification bar.
 - **Blink LED** to blink the LED indicator when notification is on the notification bar.
3. Read a message and touch **OK**.
4. Touch **OK** to assign a persistent alert type.

Dial Pad Touch Tones

Play tones when using the dialpad.

1. Press **Home**  > **Menu**  > **System settings** > **Sound**.
2. Select the **Dial pad touch tones** check box.

Touch Sounds

Play sounds when making an onscreen selection.

1. Press **Home**  > **Menu**  > **System settings** > **Sound**.
2. Select the **Touch sounds** check box.

Screen Lock Sound

Play sounds when locking and unlocking the screen.

1. Press **Home**  > **Menu**  > **System settings** > **Sound**.
2. Select the **Screen lock sound** check box.

Vibrate on Touch

Vibrate the keys when typing the keyboards.

1. Press **Home**  > **Menu**  > **System settings** > **Sound**.
2. Select the **Vibrate on touch** check box.

Hearing Aid

Use the hearing aid device effectively.



1. Press **Home**  > **Menu**  > **System settings** > **Sound**.
2. Select the **Hearing aid** check box.

Display Settings

Adjusting your phone's display settings not only helps you see what you want, it can also help increase battery life.



Brightness

Adjust your screen's brightness to suit your surroundings.

1. Press **Home**  > **Menu**  > **System settings** > **Display** > **Brightness**.
2. Use the slider to set the brightness.
– or –
Select the **Automatic brightness** check box to set the brightness automatically.
3. Touch **OK**.

Wallpaper

Select and assign your phone's background wallpaper.

1. Press **Home**  > **Menu**  > **System settings** > **Display** > **Wallpaper**.
2. Touch an option to set the wallpaper:
 - **Gallery** to set a saved picture in **Gallery**. Select an album, select an image and use the crop tool to resize it.
 - **ID wallpapers** to set an ID wallpaper. Select an image included in your ID pack.
 - **Live Wallpapers** to set a live wallpaper. Select an image. You may touch **Settings...** to select custom settings for the live wallpaper.

- **Wallpapers** to set a preset wallpaper. Slide the small image on the screen sideways to see available options and select an image.

3. Touch **Set wallpaper**.

Auto-Rotate Screen



Your phone is capable of automatically changing the orientation of some onscreen content. With this feature, you can view the screen in either portrait or landscape orientation by turning the phone sideways. By default, the screen orientation automatically changes when the phone is rotated.

To deactivate the Auto-rotate feature:

1. Press **Home**  > **Menu**  > **System settings** > **Display**.
2. Clear the **Auto-rotate screen** check box.



Sleep

Select the delay time before the screen automatically turns off.

1. Press **Home**  > **Menu**  > **System settings** > **Display** > **Sleep**.
2. Select a delay time.



Font Size

Choose the font size of the screen as you like.

1. Press **Home**  > **Menu**  > **System settings** > **Display** > **Font size**.
2. Select your favorite size.

Key Backlight



Select the delay time before the key backlight automatically turns off.

1. Press **Home**  > **Menu**  > **System settings** > **Display** > **Key backlight**.
2. Select a delay time.

Screen Proximity Safety

Set the distance between your phone and your face that triggers your phone's proximity sensor to work.

Note: If you disable the proximity sensor, it may cause accidental key presses during a call.

1. Press **Home**  > **Menu**  > **System settings** > **Display** > **Screen proximity safety**.



2. Use the slider to set the distance from your face and touch **OK**.

Storage Settings

The Storage settings menu lets you manage internal storage on your phone and provides options for your microSD card.

Device Memory

The internal storage menu lets you view your phone's internal storage capability and available space.

- ▶ Press **Home**  > **Menu**  > **System settings** > **Storage**.
 - View your device memory storage total space and space used by specific features.
 - Touch an itemized category for additional details.

Phone



Your phone has some internal space for storing pictures, music, etc. just like the SD card. For switching the designated storage area of your phone between phone and SD card, see [Primary Storage](#).

SD Card

The SD card options let you view the card's size and available space, unmount the card for data protection, and format (erase) the SD card. For more information on the SD card, see [microSD Card](#).

Primary Storage

Select your primary storage.

1. Press **Home**  > **Menu**  > **System settings** > **Storage** > **Select Primary Storage**.
2. Select **Phone** or **SD card**.
3. Read the message and touch **OK**.

Battery Settings



Monitor your phone's battery usage through this settings menu. View which functions are consuming your battery's charge and at what percentage.

1. Press **Home**  > **Menu**  > **System settings** > **Battery**.
2. View your phone's battery usage statistics.

3. Touch [# of hours, minutes and seconds] **on battery** to see the history details of the battery usage.
4. For additional details and settings options, touch a usage category.

PC Connection Settings



Set your phone's default connection mode when connected to the USB port of a computer.

1. Press **Home**  > **Menu**  > **System settings** > **PC connection**.
2. Touch **Default connection type** and select an option:
 - **Charge Only** to let your PC charge your phone only.
 - **Mass Storage** to let your phone function as a removable disk when connected to the USB port of a computer.
 - When a microSD card is inserted, it is also recognized as a separate removable disk from the phone.
 - **Media Transfer** to let your phone function as a media device when connected to the USB port of a computer.
 - **Phone as Modem** to let your phone function as a modem when connected to the USB port of a computer.
3. Select the **Ask me** check box if you want to display the selection screen whenever you connect your phone to a computer.

If the **Ask me** check box is selected, the selection screen is displayed whenever you connect your phone to a computer. If you want this selection set as default, check **Remember this choice** > **Done** on the selection screen.

Apps Settings

This menu lets you view applications on your phone.



1. Press **Home**  > **Menu**  > **System settings** > **Apps**.
2. Touch one of the following tabs to select the applications to be displayed:
 - **DOWNLOADED** to display the downloaded applications. You can also see the storage status on your phone on the bottom of the screen.
 - **ON SD CARD** to display the applications stored on the microSD card and the phone's internal storage space. You can also see the status of the primary storage on the bottom of the screen.

- **RUNNING** to display currently the running applications. You can also see the RAM status on your phone at the bottom of the screen. Touch **SHOW CACHED PROCESSES** to see the cached processes of the application.
- **ALL** to display all applications on your phone and the installed SD card.





Accounts & Sync Settings

Add and manage all your email, social networking, and picture and video sharing accounts.

Set Up a New Account



1. Press **Home**  > **Menu**  > **System settings** > **Accounts & Sync** > **ADD ACCOUNT**.
2. Touch an account type.
 - Corporate, Email, Google, etc.
3. Enter your account information and touch **Next**.
 - Depending on the account type, you may need to enter an email address or user address, password, domain name, or other information. For Corporate Sync accounts, contact your server administrator to determine what information you will need.
4. If required, touch **Done** when you are finished.

Manage Existing Accounts

1. Press **Home**  > **Menu**  > **System settings** > **Accounts & Sync**.
2. Select an account.
 - Select a check box next to the item to sync.
 - Press **Menu**  > **Remove account** to delete the account from your phone.
 - Press **Menu**  > **Sync now** to sync immediately.

Location Services Settings

Your Location Services settings menu lets you select how your phone determines its location (using the wireless network, GPS satellites, both, or neither).

1. Press **Home**  > **Menu**  > **System settings** > **Location services**.
2. Select the check boxes for your location options:

- **Google's location service** uses Wi-Fi and mobile networks to determine location.
 - **GPS satellites** uses GPS to provide location accurate to street level.
 - **NMEA output** enables GPS-NMEA location data output via USB cable.
 - **Location & Google search** allows Google to use your location data for improved search results and other services.
3. Read the disclaimer and touch **Agree**, if it appears.

Security Settings

The Security settings menus let you set encryption options, password visibility, administrator settings, and credential storage options.

Screen Lock

You can increase the security of your phone by creating a screen lock. When enabled, you have to draw the correct unlock pattern on the screen, enter the correct PIN, or enter the correct password to unlock the phone's control keys, buttons, and touchscreen.



If you fail to enter the correct pattern, PIN or password after five attempts, you will have to wait for 30 seconds before you can try again.

In order from least secure to most secure, the available screen lock options are:



- None
- Slide
- Face unlock
- Pattern
- PIN
- Password

Important: To protect your phone and data from unauthorized access, Sprint recommends using the highest security level available (Password protection). Sprint also recommends you frequently change your password to ensure the safety of your phone and personal data.



Use Slide to Unlock the Screen

1. Press **Home**  > **Menu**  > **System settings** > **Security** > **Screen lock**.
2. Touch **Slide** to save the setting.

Use Face Unlock



1. Press **Home**  > **Menu**  > **System settings** > **Security** > **Screen lock**.
2. Touch **Face Unlock**.
3. Read a message and touch **Set it up**.
4. Read a message and touch **Continue**.
5. Using the front-facing camera, adjust the phone so that your face fits in the area outlined with dots on the screen.
6. The message “**Face captured.**” appears when the Face Unlock set up was successful. Touch **Continue**.
7. You will be prompted to set up a backup lock. Select **Pattern** or **PIN** and set it up. See [Use a Screen Unlock Pattern](#) or [Use a Screen Unlock PIN](#).
8. To unlock, turn on the phone and look at the front-facing camera so that it recognizes you. If it fails to recognize you, a backup lock screen appears. Enter a pattern or PIN to unlock.

Use a Screen Unlock Pattern



1. Press **Home**  > **Menu**  > **System settings** > **Security** > **Screen lock**.
2. Touch **Pattern**.
3. Read the information and study the example pattern on the screen, and then touch **Next**.
4. Draw the screen unlock pattern by connecting at least four dots in a vertical, horizontal, or diagonal direction. Lift your finger from the screen when finished.
5. The phone records the pattern. Touch **Continue**.
6. When prompted, draw the screen unlock pattern again, and then touch **Confirm**.

Note: Clear the **Make pattern visible** check box if you do not want the unlock pattern to display on the screen when you draw it.

Use a Screen Unlock PIN



1. Press **Home**  > **Menu**  > **System settings** > **Security** > **Screen lock**.
2. Touch **PIN**.
3. Enter a PIN, touch **Continue**, re-enter your PIN, and touch **OK** to save the setting.

Use a Screen Unlock Password

1. Press **Home**  > **Menu**  > **System settings** > **Security** > **Screen lock**.
2. Touch **Password**.
3. Enter a password, touch **Continue**, enter your password again, and touch **OK** to save the setting.



Important: To protect your phone and data from unauthorized access, Sprint recommends using a screen unlock password (highest security). Sprint also recommends you frequently change your password to ensure the safety of your phone and personal data.

Disable the Screen Lock

1. Press **Home**  > **Menu**  > **System settings** > **Security** > **Screen lock**.
2. Draw your unlock screen pattern, enter your PIN, or enter your password.
3. Touch **None**.

Automatically Lock

Set the delay time the screen lock feature activates after it goes to sleep.

1. Press **Home**  > **Menu**  > **System settings** > **Security** > **Automatically lock**.
2. Select the delay time to lock the screen.

Power Button Instantly Locks

Activate the screen lock feature by pressing the power button.

1. Press **Home**  > **Menu**  > **System settings** > **Security**.
2. Select the **Power button instantly locks** check box.

Vibrate on Touch

Let the phone vibrate when you draw a pattern or enter a PIN.

1. Press **Home**  > **Menu**  > **System settings** > **Security**.
2. Select the **Vibrate on touch** check box.

Owner Information

Display the text on the lock screen.

1. Press **Home**  > **Menu**  > **System settings** > **Security** > **Owner info**.



2. Touch the field and type text to display on the lock screen. The text will be displayed on the lock screen when the **Show owner info on lock screen** check box is selected.

Encryption

You can encrypt your phone and the SD card installed in your phone. For both encryption and decryption, you need to enter a PIN or password for the screen lock. To set up a PIN or password, see [Screen Lock](#).



Warning: Once the encryption is performed, it cannot be undone. The process to remove the encryption will be a factory data reset for the phone and a formatting for the SD card, which will delete all the data on the phone and the SD card.

Warning: Refrain from using the phone, including removing the battery and the SD card, during the encryption process as some or all of your data will be lost if the encryption process is interrupted.

1. Charge the battery first.
2. With your phone connected to the power source, press **Home**  > **Menu**  > **System settings** > **Security** > **Encrypt data**.
3. Select the target to be encrypted from **Phone & SD card**, **Phone**, or **SD card**.
4. Read the message and touch **Next**.
5. Enter a PIN or password and touch **Next**.
6. Read the message and touch **Encrypt**.

Set Up SIM Card Lock

Protect your SIM card with a PIN.

1. Press **Home**  > **Menu**  > **System settings** > **Security** > **Set up SIM card lock**.
2. Select the **Lock SIM card** check box.
3. Enter your SIM PIN and touch **OK**.
4. To change the SIM PIN, touch **Change SIM PIN**.
5. Enter a new PIN and touch **OK**.



Make Passwords Visible

You can hide your password or PIN number as you type it.

1. Press **Home**  > **Menu**  > **System settings** > **Security**.
2. Clear the **Make passwords visible** check box.

Device Administrators

You can disable the authority to be a device administrator of certain applications. If disabled, you will typically lose some functionality in those applications, such as the ability to sync new email or calendar events to your phone.

1. Press **Home**  > **Menu**  > **System settings** > **Security** > **Device administrators**.
2. Touch an application you want to disable the authority to be a device administrator.

Unknown Sources

Follow the steps below to allow installation of non-Play Store applications.



1. Press **Home**  > **Menu**  > **System settings** > **Security**.
2. Touch **Unknown sources** > **OK**.

Credential Storage

These options let you control how your phone accesses and stores secure certificates, passwords, and other credentials.



Trusted Credentials

You can see the trusted credentials on your phone's system.

1. Press **Home**  > **Menu**  > **System settings** > **Security** > **Trusted credentials**.
2. Touch an item to read the information.



Install from SD Card

You can install encrypted certificates from the SD card.

1. Press **Home**  > **Menu**  > **System settings** > **Security** > **Install from SD card**.
2. Touch an available certificate.
3. Follow the onscreen instructions.

Clear Credentials

You can remove all the credentials on your phone.

1. Press **Home**  > **Menu**  > **System settings** > **Security** > **Clear credentials**.
2. Touch **OK**.



Language & Input Settings

Your phone's language and input settings let you select a language for the phone's menus and keyboards, select and configure keyboard settings, configure speech input settings, and more. For details, see [Enter Text](#).

This menu also provides the settings when using voice function. See [Text-to-Speech Settings](#) and [Voice Search](#).



Language Settings

The language settings menu lets you select an onscreen language and add custom words to your phone's user dictionary.

1. Press **Home**  > **Menu**  > **System settings** > **Language & input** > **Language**.
2. Select **English** or **Español**.

Pointer Speed

Change the pointer speed.

1. Press **Home**  > **Menu**  > **System settings** > **Language & input** > **Pointer speed**.
2. Use the slider to set the speed and touch **OK**.



Back Up and Reset Phone Settings

Your phone's Back up and reset menu lets you back up your phone's data and settings to Google servers before resetting your phone to the original factory settings. The Factory data reset erases all data from the phone's application storage, including:

- Your Google Account
- All other email and social networking accounts
- System and application data and settings
- Downloaded applications



Backup and Restore



To set your backup and restore options:

1. Press **Home**  > **Menu**  > **System settings** > **Backup & reset**.
2. Select your backup and restore options.

- **Back up my data:** This option lets you back up your app data, Wi-Fi passwords, and other settings to Google servers.
- **Backup account:** Select a Google account for your phone backup.
- **Automatic restore:** This option lets you restore backed up settings and data when reinstalling an application after a factory data reset.



Factory Data Reset

Tip: Before performing a factory data reset on your phone, you may want to unmount the microSD card to avoid losing any data you may have stored on it. Press **Home**  > **Menu**  > **System settings** > **Storage** > **Unmount SD card** to unmount the storage card.

1. Press **Home**  > **Menu**  > **System settings** > **Backup & reset**.
2. Touch **Factory data reset**.
3. Read the factory data reset information, select the **Erase SD card** check box if necessary, and touch **Reset phone**.
4. Touch **Erase everything**. Your phone will power down and reset itself, which may take up to 10 minutes.

Date & Time Settings

Use the Date & Time settings menu either to automatically use the network-provided date and time or manually set these values, as well as select time and date format options.



1. Press **Home**  > **Menu**  > **System settings** > **Date & time**.
2. Clear the **Automatic date & time** check box if necessary.
3. Clear the **Automatic time zone** check box if necessary.
4. Touch **Set date**. Adjust the date, month, and year by touching ▲ or ▼ or scrolling each value. Touch **Set** when finished.
5. Touch **Set time**. Adjust the hour and minute, and select AM or PM by touching ▲ or ▼ or scrolling each value. Touch **Set** when finished.
6. Touch **Select time zone**, and then select a time zone from the onscreen list. Scroll down the list to view additional time zones.
7. Touch **Use 24-hour format** to toggle between 12-hour or 24-hour format.
8. Touch **Select date format** to select how the date information is displayed on your phone.

Accessibility Settings

The Accessibility menu lets you enable and manage accessibility-related applications.





Services

This menu provides you with the list of accessibility-related applications.

1. Press **Home**  > **Menu**  > **System settings** > **Accessibility**.
2. Touch an application and configure its settings.

TalkBack

TalkBack provides spoken feedback to help visually impaired users.

1. Press **Home**  > **Menu**  > **System settings** > **Accessibility** > **TalkBack**.
2. To turn it on, touch the off icon , read a message and then touch **OK**. The on icon  is displayed.
3. Touch **SETTINGS** to configure its settings.



Large Text

Use large fonts on the screen.



1. Press **Home**  > **Menu**  > **System settings** > **Accessibility**.
2. Select the **Large text** check box.

Power Button Ends Call

Use the power button to end a call.

1. Press **Home**  > **Menu**  > **System settings** > **Accessibility**.
2. Select the **Power button ends call** check box.



Auto-Rotate Screen

Automatically change the orientation of some onscreen content when the phone is rotated. This option can be set from **Home**  > **Menu**  > **System settings** > **Display** > **Auto-rotate screen** as well.

1. Press **Home**  > **Menu**  > **System settings** > **Accessibility**.
2. Select the **Auto-rotate screen** check box.



Speak Passwords

Let your phone speak the password you enter.

1. Press **Home**  > **Menu**  > **System settings** > **Accessibility**.
2. Select the **Speak passwords** check box.



Explore by Touch

Hear or see descriptions of what's under your finger. This option is available when TalkBack is turned on.

1. Press **Home**  > **Menu**  > **System settings** > **Accessibility**.
2. Touch **Explore by touch**.
3. Touch the off icon to turn it on and then touch **OK**.



Touch & Hold Delay

Set the delay time when the screen recognizes the touch and hold operation.

1. Press **Home**  > **Menu**  > **System settings** > **Accessibility**.
2. Touch **Touch & hold delay**.
3. Select **Short**, **Medium**, or **Long**.

Install Web Scripts

Install web scripts that make the web content more accessible.

1. Press **Home**  > **Menu**  > **System settings** > **Accessibility**.
2. Touch **Install web scripts**.
3. Read a message and touch **Allow**.

DC Button

If you don't subscribe to Sprint Direct Connect services, you can use the DC button for other function.

1. Press the DC button and touch **Customize**, if available.

– or –

Press **Home**  > **Menu**  > **System settings** > **Accessibility** > **DC button**.

2. Select a function to assign to the button, or select **Do nothing** to assign no specific function.

See [One Touch DC](#) for the functions you can assign to the DC button when you subscribe to Sprint Direct Connect services



Developer Options Settings

These menus are specific for application development. Unless you have a specific reason for changing these settings, you should leave them at the default settings.

- ▶ Press **Home**  > **Menu**  > **System settings** > **Developer options**.



Activate This Device

The Activate this device menu lets you activate a new device or use additional self-service options such as checking the status of an in-service device.

1. Press **Home**  > **Menu**  > **System settings** > **Activate this device**.
2. Follow the onscreen instructions.



About Phone

The About phone menu lets you access important phone information including your phone number, battery status, and view legal information.

- ▶ Press **Home**  > **Menu**  > **System settings** > **About phone**.

System Update

The System update menu lets you update your PRL (preferred roaming list), your data user profile, your Android software, and your phone firmware.

1. Press **Home**  > **Menu**  > **System settings** > **System update**.
2. Select an option and follow the prompts to complete the updates. For complete system update information see [Update Your Phone](#).

UICC Unlock

UICC Unlock will check and enable the use of an optional SIM card.

1. Press **Home**  > **Menu**  > **System settings** > **System update**.
2. Check the **UICC Unlock** check box.

Copyright Information

©2013 Sprint. SPRINT and the logo are trademarks of Sprint. KYOCERA is a registered trademark of Kyocera Corporation. Other marks are the property of their respective owners.

Android, Google Play, Google Maps, Gmail and Google Talk are trademarks of Google Inc.

The Bluetooth® word mark and logos are registered trademarks owned by Bluetooth SIG, Inc. and any use of such marks by Kyocera Corporation is under license. Other trademarks and trade names are those of their respective owners.

Swype and the Swype logos are registered trademarks or trademarks of Nuance Communications, Inc. © 2013 Nuance Communications, Inc. All rights reserved.



microSD and microSDHC Logos are trademarks of SD-3C, LLC.



Index

- 3-Way Calling, 45
- 4G, 120
- About Phone, 201
- Accessibility Settings, 199
 - Auto-rotate screen, 199
 - DC button, 200
 - Explore by touch, 200
 - Install Web scripts, 200
 - Large text, 199
 - Power button ends call, 199
 - Services, 199
 - Speak passwords, 200
 - Touch & hold delay, 200
- Accessory Jack, 10
- Account Passwords, 7
- Accounts, 80
 - Add new, 191
 - Manage, 191
- Accounts & Sync Settings, 191
- Activate This Device, 201
- Activation, 5
- Airplane Mode, 180
- Alarm, 154
- Android Beam, 164
- Android Keyboard, 26
 - Settings, 29
 - User dictionary, 28
 - Voice input, 28
- Answer
 - Direct Connect call, 56
- Answer a Call, 36
- Applications, 100
- Apps, 100
 - Find and install, 100
 - Open, 102
 - Request refunds, 102
 - Uninstall, 103
- Apps Settings, 190
- Automatic Speech Recognition (ASR), 157
- Auto-Rotate Screen, 188
- Back Key, 10
- Back Up Phone, 197
- Battery
 - Charge, 3
 - Install, 2
 - Settings, 189
- Bluetooth, 159
 - Change device name, 160
 - Connect, 160
 - Disconnect, 161
 - Receive information, 163
 - Send information, 162
 - Settings, 178
 - Settings menu, 160
 - Share pictures and videos, 146
 - Turn on or off, 159
 - Unpair, 161
- Bookmarks, 131
 - Add to home screen, 132
- Brightness, 187
- Browser, 124
 - Bookmarks, 131
 - Create new home page, 131
 - Go to a website, 127
 - Home page, 130
 - Launch connection, 121, 124
 - Menu, 125
 - Navigate, 124
 - Reset, 130
 - Select text on a Web page, 126
 - Settings, 127
 - Website settings, 130
 - Zoom, 125
- Calculator, 156
- Calendar, 148
 - Add event, 148
 - Erase events, 152
 - Event alerts, 149
 - Invite guests, 149
 - Show or hide calendars, 153

- Sync Google calendars, 153
- View events, 150
- Call
 - Settings, 48
- Call Alerts, 57
 - Reply, 58
 - Send, 57
- Call Forwarding, 46
- Call Log
 - Make Direct Connect call from, 54, 59
- Call Logs, 47
 - Clear, 48
 - Make call from, 33
 - Options, 47
 - View, 47
- Call Waiting, 45
- Caller ID, 45
- Camera, 134
 - Close, 134
 - Open, 134
 - Review screen, 136
 - Settings, 138
 - Take a picture, 135
 - Viewfinder, 134
- Camera Button, 10
- Car Kit
 - Connect, 160
- Charge Battery, 3
- Charger/Accessory Jack, 10
- Clock, 153
 - Alarm, 154
 - Open, 153
- Connections Optimizer, 119
- Contacts, 68
 - Add a Group Connect contact, 76
 - Add a group contact, 74
 - Add contact, 70
 - Add to Favorites, 74
 - Assign a picture, 72
 - Assign a ringtone, 73
 - Assign a vibration, 73
 - Delete, 74
 - Edit, 72
 - Edit a Group Connect contact, 76
 - Edit a group contact, 75
 - Get started, 68
 - ICE, 76
 - Make call from, 33
 - Make Direct Connect call from, 54
 - Save a phone number, 72
 - Send a call to voicemail, 74
 - Share, 78
 - Synchronize, 78
 - Take and assign a picture, 73
- Copy, 29
- Data, 118
- Data Services, 121
 - Password, 7
 - Status indicators, 122
 - User name, 121
- Data Usage
 - Settings, 178
- Date & Time Settings, 198
- DC Call list
 - Make a Direct Connect call from, 55
- Developer Options, 201
- Device Memory, 189
- Direct Connect, 50
 - Answer, 56
 - Availability notifications, 55
 - Beep during a call, 67
 - Before making your first call, 50
 - Call Alerts, 57
 - Call Alerts sound, 185
 - Call by entering a number, 52
 - Call from Call log, 54
 - Call from contacts, 54
 - Call from DC call list, 55
 - Convert to a phone call, 56
 - DC calls sound, 185
 - DC headset mode, 66
 - Direct Connect number, 50
 - Display your number, 52
 - End a call, 57
 - Group Connect, 58
 - Group Connect call information, 60
 - Group Connect termination options, 66
 - Invites, 63

- Join or rejoin a Group Connect call, 60
- Join or rejoin a TeamDC call, 62
- Make call, 51, 52
- Make Group Connect call, 58
- Make TeamDC call, 61
- One touch DC, 66, 200
- Opt-In TeamDC, 63
- Permissions, 65
- Remove yourself from a TeamDC group, 62
- Reply to Call Alerts, 58
- Reply to Invites, 64
- Save numbers, 51
- Scan lock, 63
- Send Call Alerts, 57
- Send Invites, 63
- Set up a TeamDC group, 60
- Settings, 64
- TeamDC, 60
- TeamDC call information, 62
- Turn on and off, 64
- Update a TeamDC group, 61
- Direct Connect Button, 10, 66, 200
- Direct Connect Call, 52
 - By entering a number, 52
 - From Call log, 54, 59
 - From contacts, 54
 - From DC call list, 55
- Direct Connect Calls
 - Using speed dialing, 54
- Display Settings, 187
 - Auto-rotate screen, 188
 - Brightness, 187
 - Font size, 188
 - Key backlight, 188
 - Screen proximity safety, 188
 - Sleep, 188
 - Wallpaper, 187
- Drag, 13
- Eco Mode, 159
- Email
 - Account settings, 87
 - Add account, 83
 - Add corporate account, 84
 - Compose, 85
 - Delete account, 88
 - General settings, 86
 - Make call from, 34
 - Manage inbox, 86
 - Reply, 85
 - Send, 85
 - Send Gmail, 82
 - Share pictures, 145
 - View, 85
- Emergency Numbers, 34
- End
 - Direct Connect call, 57
- Enhanced 911 (E911), 34
- Enter Text, 21
- Extended Home Screen, 17
- Factory Data Reset, 198
- Favorites Tray, 18
- Flash, 11
- Flick, 14
- Folders, 18
- Font Size, 188
- Gallery, 140
 - Close, 141
 - Open, 141
 - View pictures and videos, 141
- Gestures, 12
- Global Roaming Mode, 171
- Gmail
 - Access, 81
 - Create account, 80
 - Read, 82
 - Reply, 82
 - Send message, 82
 - Share pictures, 145
- Google
 - Create account, 80
 - Sign in, 81
- Google Latitude, 108
- Google Maps, 103
- Google Navigation, 107
- Google Play
 - Find and install apps, 100
 - Google Wallet Account, 101

- Help, 103
- Store, 100
- Google Talk, 95
 - Manage friends, 97
 - Mobile indicators, 98
 - Settings, 98
 - Sign in and chat, 95
 - Sign out, 98
- Google Voice Typing, 28
- Google+
 - Share pictures and videos, 146
- GPS Satellites, 191
- Group Connect, 58
 - Call Information, 60
 - Join or rejoin a call, 60
 - Make call, 58
 - Termination options, 66
- Headset
 - Connect, 160
- Headset Jack, 10
- Hearing Aid, 187
- Home Key, 10
- Home Screen, 16
 - Add items, 18
 - Customize, 17
 - Extended, 17
 - Favorites tray, 18
 - Folders, 18
 - Move or remove items, 18
 - Overview, 16
 - Wallpaper, 19
- ICE (In Case of Emergency), 76
- In-call Options, 43
- Incoming Call
 - Answer, 36
- International Data Roaming, 174
- Internet Calling, 35
- Invites, 63
 - Reply, 64
 - Send, 63
- Key Backlight, 188
- Keyboard
 - Android keyboard, 26
 - Swype, 21
- Touchscreen, 21
- Language, 197
- Language & Input Settings, 197
- LED Flashlight, 156
- Location
 - GPS satellites, 191
 - Wireless networks, 191
- Location Services
 - Settings, 191
- Make a Call
 - Using ASR, 157
- Make a Group Connect Call, 58
- Make a TeamDC Call, 61
- Maps, 103
- MaxiMZR
 - Settings, 178
- Menu Key, 10
- Messaging, 80
- Microphones, 10
- microSD Card, 165
 - Format, 167
 - Insert, 165
 - Remove, 166
 - Unmount, 167
 - Use as a media device, 168
 - Use as a USB driver, 167
 - View memory, 167
- MMS
 - Message Conversations, 91
 - Notifications, 91
 - Options, 93
 - Send messages, 89
 - Share pictures and videos, 145
- Mobile Networks
 - Settings, 181
- Music, 111
 - Back up downloaded data, 115
 - Open Library, 111
 - Play, 111
 - Playlists, 114
 - Queue, 113
 - Search, 113
- Navigation, 103
 - Google Latitude, 108

- Google Maps, 103
- Google navigation, 107
- Scout by Telenav, 106
- Near Field Communication Technology, 164
- NFC, 164
 - Android Beam, 164
 - Turn on or off, 164
- Notification Icons, 20
- Notifications, 19, 20
- Opt-In TeamDC, 63
- Paste, 29
- PC Connection Settings, 190
- Phone
 - Dialpad, 32
- Phone Calls, 32
 - Emergency numbers, 34
 - From email messages, 34
 - From text messages, 34
 - Make calls, 32
 - Receive, 36
 - Using call logs, 33
 - Using contacts, 33
 - Using Internet calling, 35
 - Using phone dialpad, 32
 - Using speed dialing, 33
 - Using the plus (+) code, 35
 - With pauses, 35
- Phone Illustration, 1
- Phone Layout (illustration), 9
- Phone Number
 - Save to contacts, 72
- Phone Update, 168
 - Firmware, 169
 - Kyocera software, 170
 - PRL, 168
 - Profile, 169
- Picasa
 - Share pictures, 146
- Pictures
 - Assign to contacts, 72
 - Crop, 144
 - Edit, 143
 - Options menu, 143
 - Rotate, 144
 - Share via Bluetooth, 146
 - Share via email, 145
 - Share via Gmail, 145
 - Share via Google+, 146
 - Share via messaging, 145
 - Take, 135
 - Take and assign to contact, 73
 - View, 141
 - Zoom, 142
- Pictures
 - Share via Picasa, 146
- Pinch, 15
- Play Store, 100
- Plus (+) Code Dial, 35
- Plus (+) Code Dialing, 172
- Pointer Speed, 197
- Portable Wi-Fi Hotspot, 132
- Power Button, 10
- Power Off, 12
- Power On, 12
- PRL Update, 168
- Receive a Call
 - Answer, 36
 - Reject and send a text, 37
 - Send to voicemail, 37
- Reset Phone, 197
- Restart Phone, 12
- Ringtone
 - Assign to a contact, 73
- Roaming, 181
 - Roaming guard, 183
 - Settings, 182
- Rotate, 15
- Save
 - Direct Connect number, 51
- Save a Phone Number, 72
- Scan Lock, 63
- Scout by Telenav, 106
- Screen Lock, 192
 - Automatically lock, 194
 - Disable, 194
 - Face, 193
 - Owner information, 194
 - Password, 194

- Pattern, 193
- PIN, 193
- Power button instantly locks, 194
- Swipe, 192
- Vibrate on touch, 194
- Screen Proximity Safety, 188
- SD Card, 165
- Security Settings, 192
 - Credential storage, 196
 - Device administrators, 196
 - Encryption, 195
 - Make passwords visible, 195
 - Screen lock, 192
 - SIM card lock, 195
 - Unknown sources, 196
- Settings, 177
- Share
 - Contacts, 78
- Silent Mode, 184
- SIM Card
 - Insert, 3
- Sleep, 188
- Slide, 14
- Smart Sonic Receiver, 9, 11
- Social Networking Accounts
 - YouTube, 94
- Sound Settings, 184
 - Call Alerts, 185
 - DC calls, 185
 - Default notifications, 185
 - Dial pad touch tones, 186
 - Hearing aid, 187
 - Persistent alerts, 186
 - Ringtone, 185
 - Screen lock sound, 186
 - Silent mode, 184
 - Touch sounds, 186
 - Vibration pattern, 185
 - Vibrate and ring, 186
 - Vibrate on touch, 187
 - Volume, 184
- Speaker, 10
- Speaker Button, 10
- Speed Dialing
 - Make call using, 33
 - Make Direct Connect call using, 54
 - Set up, 46
- Spread, 15
- Sprint 411, 8
- Sprint 4G, 120
- Sprint Account
 - Management, 7
- Sprint Connections Optimizer, 119
- Sprint ID, 115
 - Install, 116
 - Switch, 116
- Sprint Mobile Sync, 79
- Sprint Operator Services, 8
- Sprint Services, 6
- Sprint TV & Movies, 116
- Sprint Worldwide Wireless Service, 171
- Sprint Zone, 117
- Status Bar, 19
- Status Icons, 19
- Storage Card, 165
- Storage Settings, 189
 - Device memory, 189
 - Primary storage, 189
- Swipe, 14
- Swype, 21
 - Settings, 25
 - User dictionary, 24
 - Voice input, 24
- Synchronize Contacts, 78
- System Update, 201
- TeamDC, 60
 - Call information, 62
 - Join or rejoin a call, 62
 - Make call, 61
 - Remove yourself from a group, 62
 - Set up a group, 60
 - Update a group, 61
- Text Entry, 21
- Text Message
 - Make call from, 34
- Text Messaging
 - Conversations, 91
 - Draft messages, 91

- Notifications, 91
- Options, 93
- Send messages, 88
- Text-to-Speech, 158
- Tools, 148
- Touch, 13
- Touch and Hold, 13
- Touchscreen
 - Keyboard, 21
 - Navigation, 12
 - Turn off, 12
 - Turn on, 12
- TTY Mode, 49
- Turn Phone Off, 12
- Turn Phone On, 12
- Typing, 21
- User Guide Notes, 1
- Video, 134
- Video Camera, 136
 - Record video, 137
 - Settings, 139
 - Viewfinder screen, 136
- Videos
 - Record, 137
 - Share via Bluetooth, 146
 - Share via Google+, 146
 - Share via messaging, 145
 - Share via YouTube, 147
 - View, 141
 - Watch, 142
- Visual Voicemail, 37
 - Compose a message, 40
 - Display name, 41
 - Greeting, 41
 - Listen to multiple messages, 39
 - Review, 38
 - Set up, 37
 - Settings, 40
- Voice Search, 158
- Voice Services, 156
 - Automatic speech recognition (ASR), 157
 - Text-to-speech, 158
 - Voice search, 158
- Voicemail, 41
 - International, 173
 - Notification, 42
 - Password, 7
 - Retrieve messages, 42
 - Set up, 5, 42
- Volume, 184
 - Button, 10
- VPN, 122
 - Add connection, 123
 - Connect or disconnect, 123
 - Install security certificates, 123
 - Prepare for connection, 123
- Wallpaper, 19, 187
- Web, 118
 - Launch connection, 121
- Website Settings, 130
- Wi-Fi, 118
 - Connect to a different network, 119
 - Settings, 177
 - Turn on and connect, 118
 - Wireless network status, 119
- Wi-Fi Direct
 - Settings, 180
- YouTube, 94
 - Share videos, 147
- Zoom, 15